



rethinking software design

Daniel Jackson · CSAIL · MIT

SATURN Conference · San Diego · May 4, 2016

what is
software design?

designers & engineers



designers & engineers

	designer	engineer
elements	door, window, wall	column, beam, truss
goals	comfortable, convenient, attractive	structural integrity, durable, sustainable

designers & engineers



designers & engineers

	designer	engineer
elements		function, object, type
goals	learnable, effective, tolerant	maintainable, correct, fast

designers & engineers

	designer	engineer
elements	?	function, object, type
goals	learnable, effective, tolerant	maintainable, correct, fast

the role of design criteria

	designer	engineer
elements	?	function, object, type
goals	learnable, effective, tolerant	maintainable, correct, fast

the role of design criteria

	designer	engineer
elements	?	function, object, type
goals	learnable, effective, tolerant	maintainable, correct, fast



the role of design criteria

	designer	engineer
elements	?	function, object, type
criteria		decoupling & localization
goals	learnable, effective, tolerant	maintainable, correct, fast

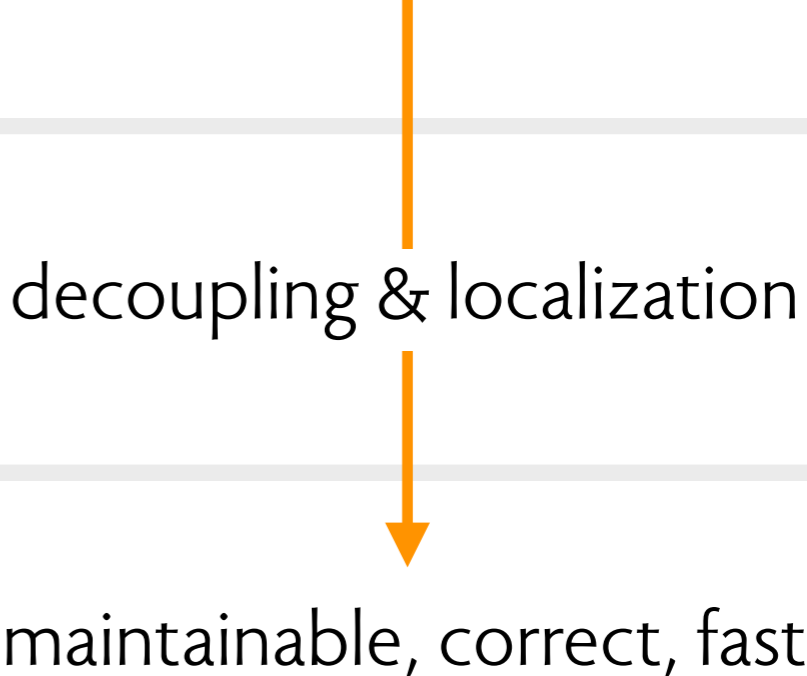

the role of design criteria

	designer	engineer
elements	?	function, object, type
criteria	?	decoupling & localization
goals	learnable, effective, tolerant	maintainable, correct, fast

The diagram illustrates a flow of information from the 'elements' row to the 'goals' row. An orange arrow points from 'function, object, type' in the 'elements' row down to 'decoupling & localization' in the 'criteria' row. A second orange arrow points from 'decoupling & localization' down to 'maintainable, correct, fast' in the 'goals' row.

WARNING

**OBSESSIVE
DETAILS
AHEAD**



That's quite obsessive, isn't it?
Jonathan Ive in "Objectified"



The details are not the details.
These make the design.
attributed to Charles Eames by Garrett

Quora

Search



Dropbox: [Edit](#)

Someone accidentally deleted thousands of files in my company Dropbox: how can I quickly undelete them? [Edit](#)

[Add Question Details](#)

[Comment](#) · [Share](#) · [Report](#) · [Options](#)

survey of MIT dropbox users

correctly predicting behavior

80.0%

60.0%

40.0%

20.0%

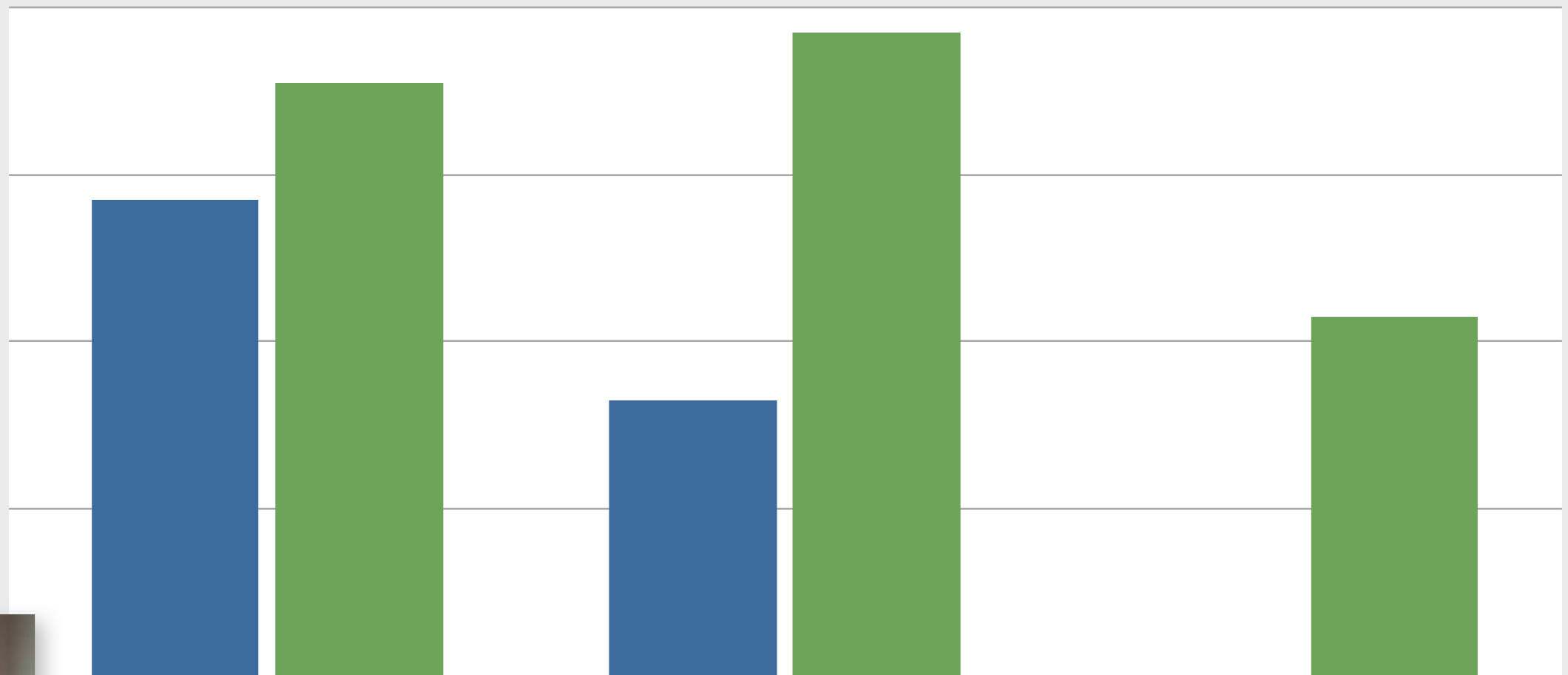

good knowledge

average knowledge

poor knowledge

- delete shared folder results in leaving
- delete shared subfolder removes it



Kelly Zhang

3

software design
problems

#1

email categories

gmail's categories

Primary			Social 23 new		Promotions 100+ new		+
<input type="checkbox"/>	<input type="star"/>	<input type="arrow"/>	Google	New sign-in from Chrome on Mac - New sign-in from Ct		12:30 pm	
<input type="checkbox"/>	<input type="star"/>	<input type="arrow"/>	Keith Muhammad at DeMont.	DeMontrond Auto Group - 14101 North Freeway Housto		12:19 pm	
<input type="checkbox"/>	<input type="star"/>	<input type="arrow"/>	AT&T High Speed Internet.	AT&T High Speed Internet Service Activation - Your A1		10:37 am	
<input type="checkbox"/>	<input type="star"/>	<input type="arrow"/>	Keith Muhammad at DeMont.	DeMontrond Auto Group - 14101 North Freeway Housto		Aug 26	
<input type="checkbox"/>	<input type="star"/>	<input type="arrow"/>	betterbatonrougejobs.com	Job Update -- 2015-08-26 - Looking For An Advantage W		Aug 26	

category tab settings

Categories:

[Learn more](#)

- Primary
- Social
- Promotions
- Updates
- Forums

Starred messages

- Include starred in Primary



Choose which message categories to show as inbox tabs. Other messages will appear in the Primary tab.

some reactions

some reactions

Everything You Need to Know About Gmail's New, **Super-Confusing** Layout



Melanie Pinola

Filed to: GMAIL 6/07/13 9:00am

301,482 🔥 12 ☆ ▾

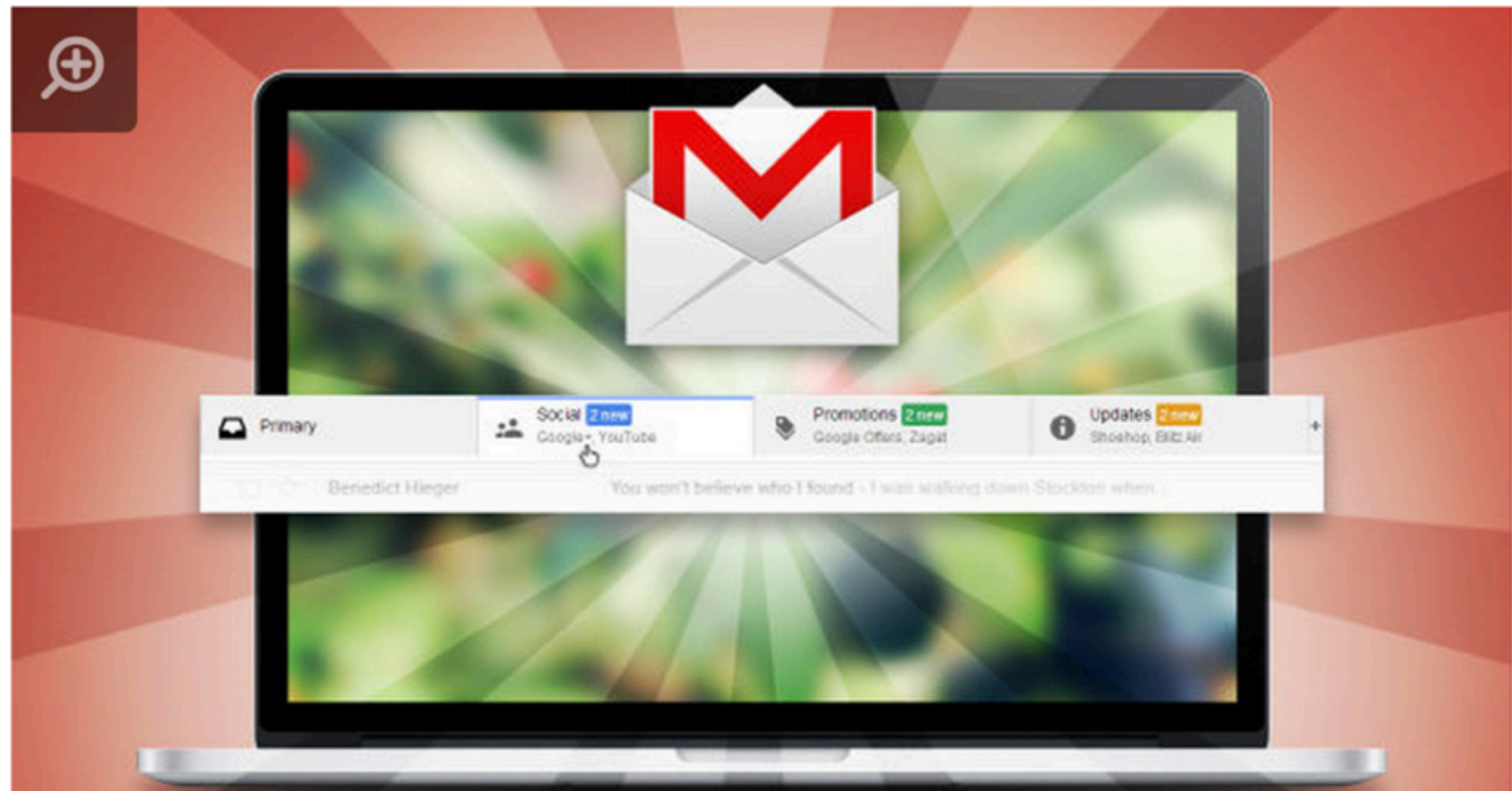

some reactions

[Home](#) › [Quick Tech Tip: Disabling Gmail's Category Tabs](#)

Quick Tech Tip: Disabling Gmail's Category Tabs

Mon, 07/29/2013 - 12:17 | [Chuck Gray](#)

in [LibraryPoint Blog](#) [Tech Tutorials](#) [Teen Blog](#) [Tech Answers](#) [Science and Technology](#) [Self-Help and Instructional](#)



Are you a Gmail user? Did you wake up a week or two ago to find that your new messages were now being automatically organized by Gmail into tabs of different, pre-determined categories? And, did you think, like me, that they were **really ugly, stupid, and unnecessary?** Here's a quick tip on how to rid yourself of them!

some reactions

Google gets it terribly, terribly wrong with Gmail tabs and makes me angry



By [Mark Wilson](#)

Published 2 years ago

Follow

71 Comments

Like 55

Share 11

37

Tweet 30

Like many Gmail users, I greeted the [news of the introduction of tabs to the interface](#) with a degree of anticipation -- now it was just a matter of waiting for the feature to roll out so I could try it for myself. Earlier today I was randomly signed out of my Gmail account, and after signing back in and checking the settings menus, I could see that tabs were now available to me. Excitement was short-lived, however; it quickly became apparent that this new feature is a disaster.



how google explains labels (!)

Gmail Help



GMAIL 

FORUM

Using labels

Labels help you organize your messages into categories – work, family, to do, read later, jokes, recipes, any category you want. Labels do all the work that folders do, but with an added bonus: you can add more than one to a message.

what you can't do

what you can't do

associate tabs with labels

feature available only for categories

what you can't do

associate tabs with labels

feature available only for categories

use tabs outside inbox

tabs disappear when you filter on a label

#2

camera settings

my camera fuji x100s



image quality setting



image quality setting



image quality setting



aspect ratio



aspect ratio



image size setting



image size setting



image size setting



image size setting



non-standard ratio + raw?



what you can't do

non-standard aspect ratio + raw

even though raw images get nice nondestructive crop!

what you can't do

non-standard aspect ratio + raw

even though raw images get nice nondestructive crop!



#3

fonts & styles

what's a font?

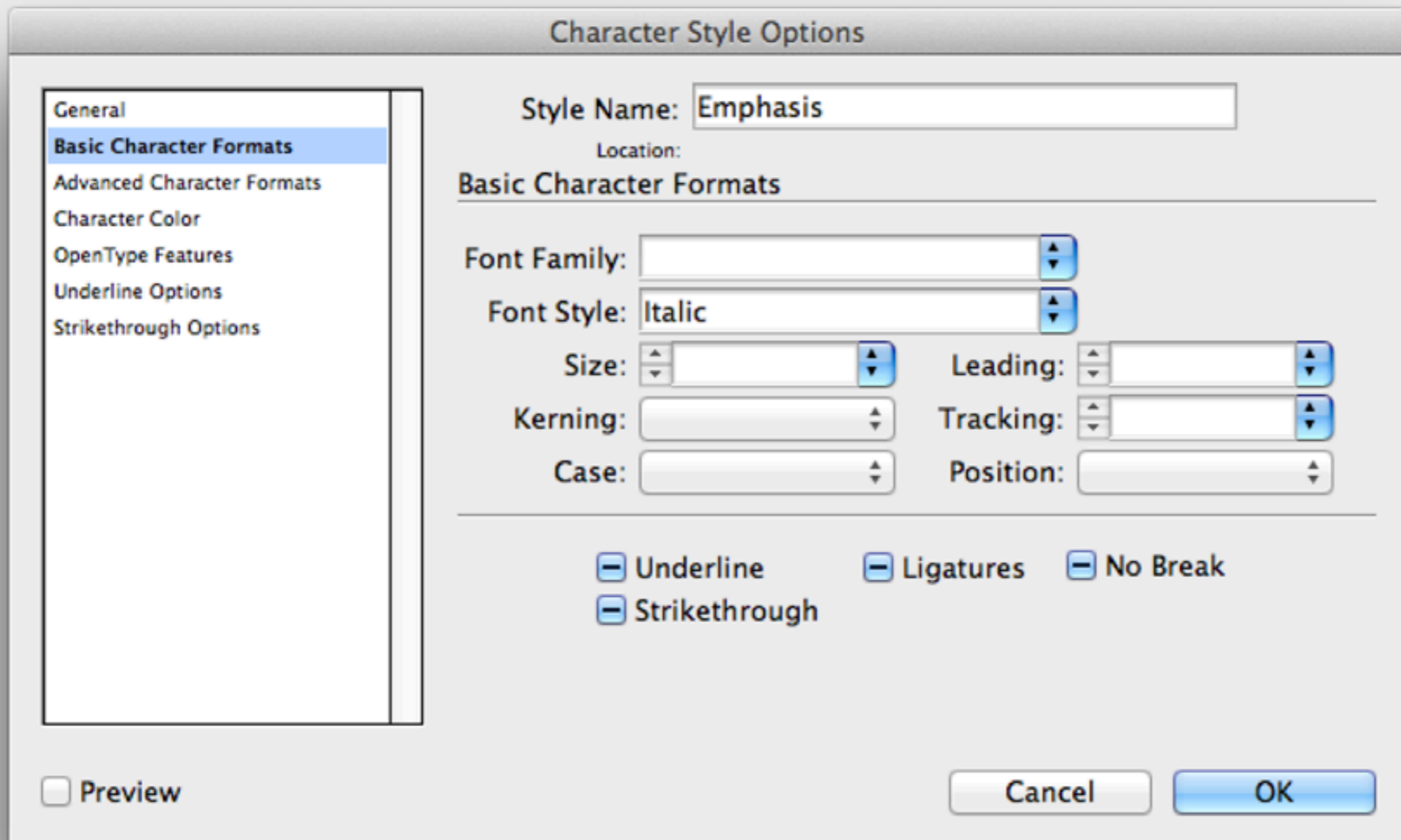

what's a font?

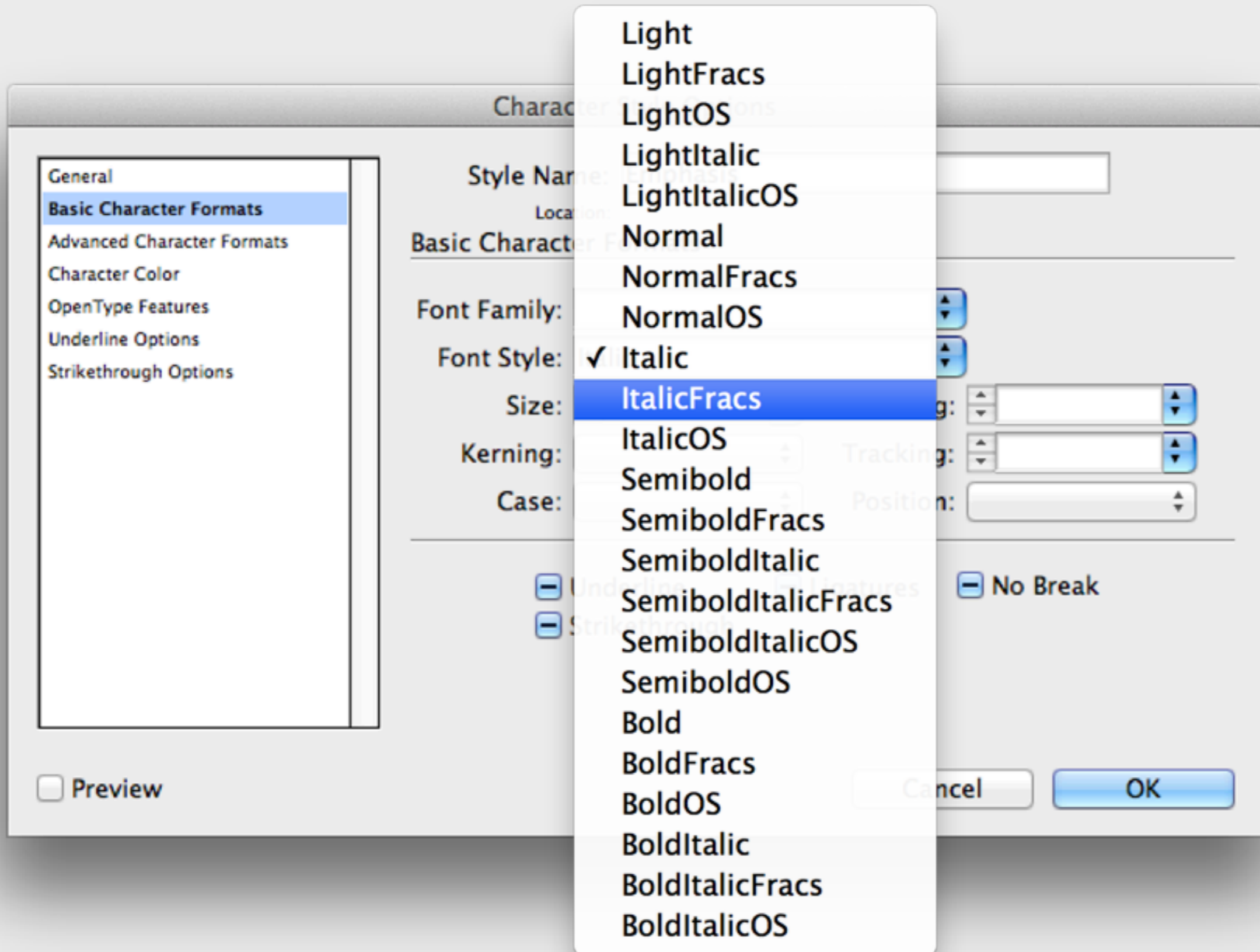

what you can't do

define a style that italicizes

Arno Regular to Arno Italic

Futura Book to Futura Book Oblique

Magma Light to Magma Light Italic

what kind of problems are these?

what kind of problems are these?

minor nitpicks?

in all cases, can't do useful things

what kind of problems are these?

minor nitpicks?

in all cases, can't do useful things

coding bugs?

code seems to meet a coherent spec

what kind of problems are these?

minor nitpicks?

in all cases, can't do useful things

coding bugs?

code seems to meet a coherent spec

user interface flaws?

interfaces are clear and faithful to function

getting to
the essence
of an app

what characterizes an app?

Apple Mail

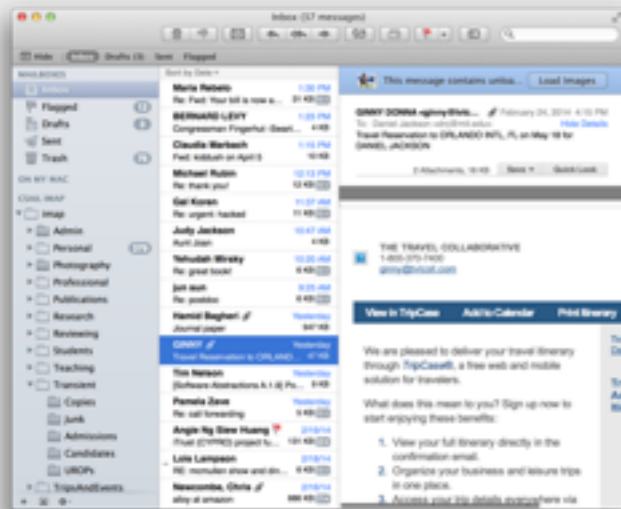

Microsoft Word

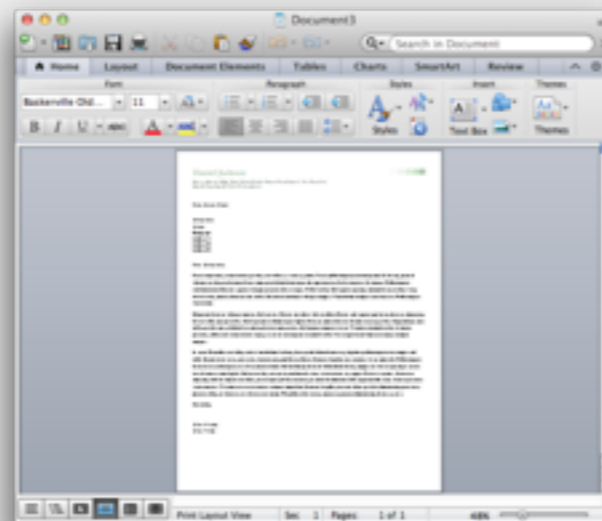

Twitter



Photoshop



what characterizes an app?

concepts!

Apple Mail

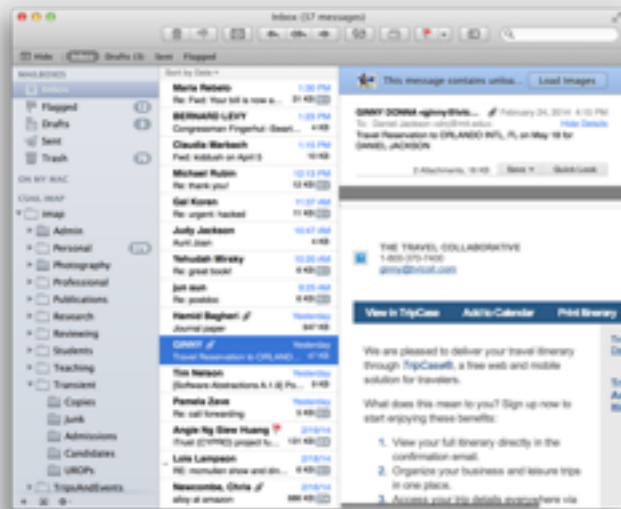

Microsoft Word

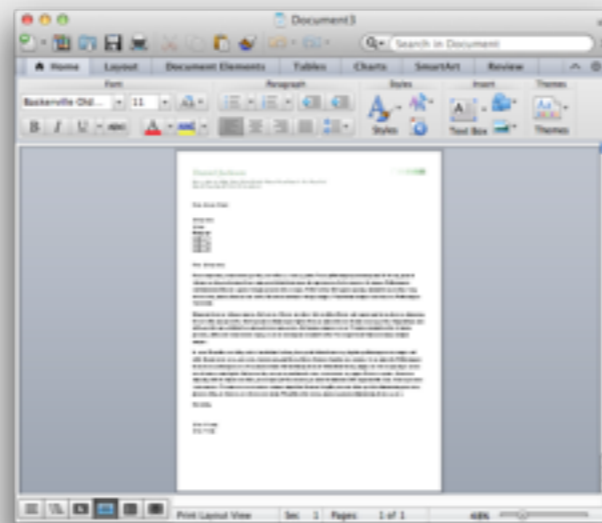

Twitter



Photoshop



what characterizes an app?

concepts!

Apple Mail

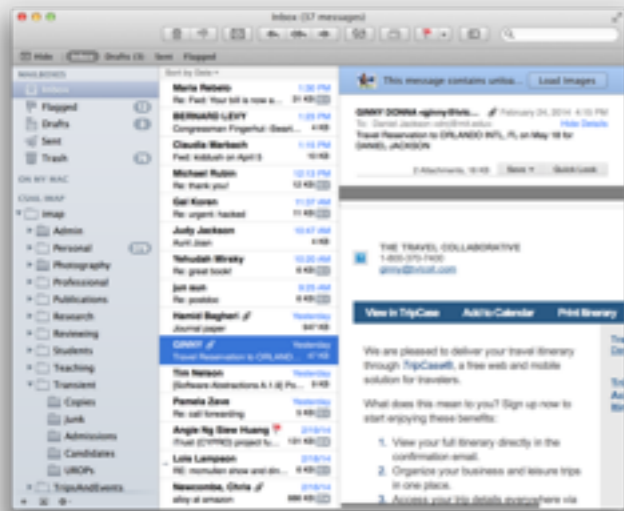

EmailAddress
Message
Folder or Label

Microsoft Word

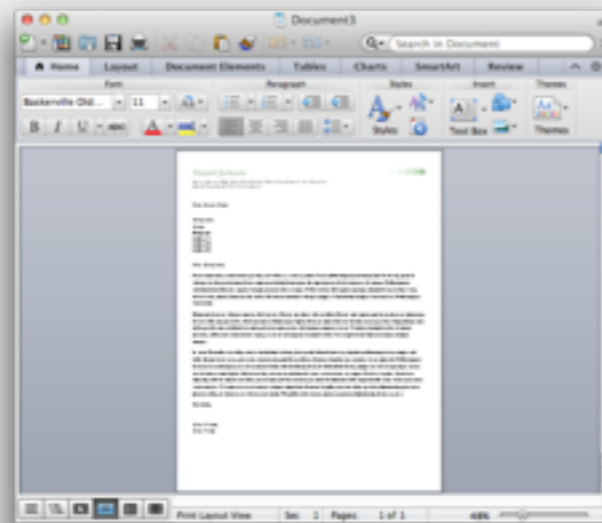

Twitter



Photoshop



what characterizes an app?

concepts!

Apple Mail

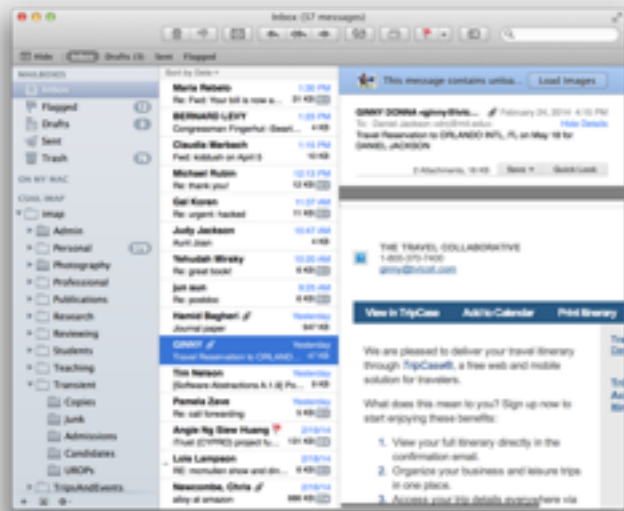

EmailAddress
Message
Folder or Label

Microsoft Word

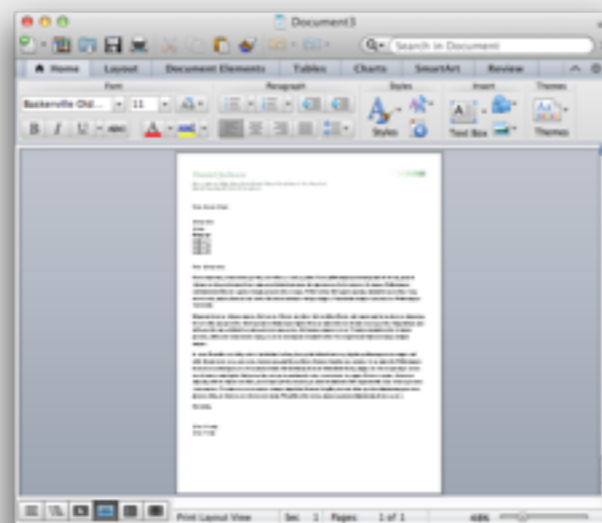

Paragraph
Format
Style

Twitter



Photoshop



what characterizes an app?

concepts!

Apple Mail

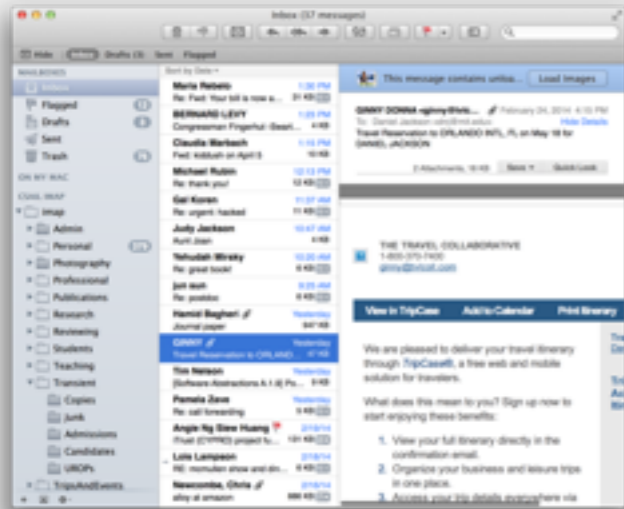

EmailAddress
Message
Folder or Label

Microsoft Word

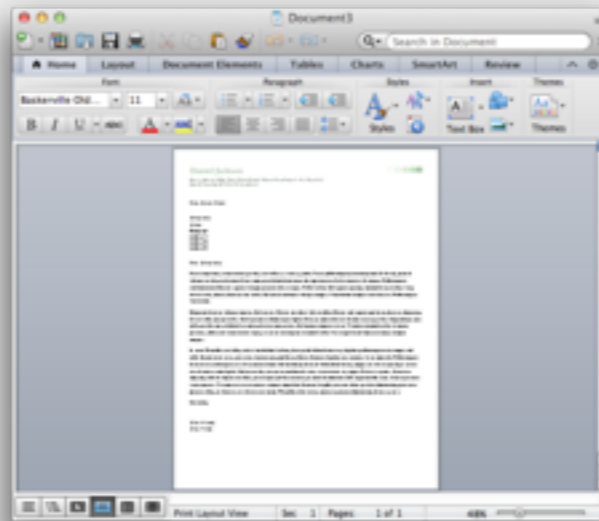

Paragraph
Format
Style

Twitter



Tweet
Hashtag
Following

Photoshop



what characterizes an app?

concepts!

Apple Mail

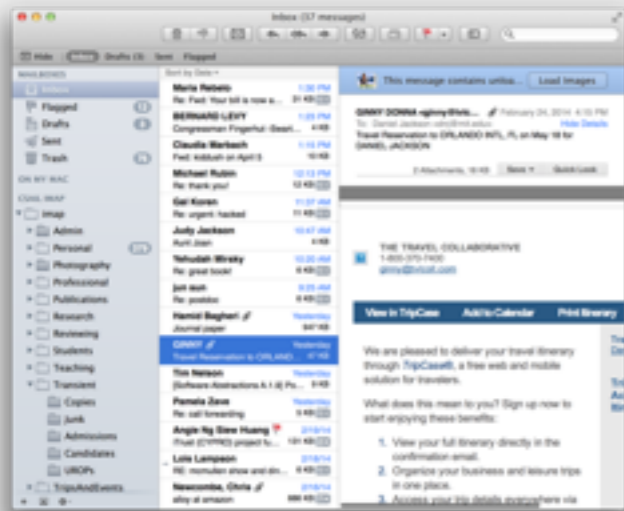

EmailAddress
Message
Folder or Label

Microsoft Word

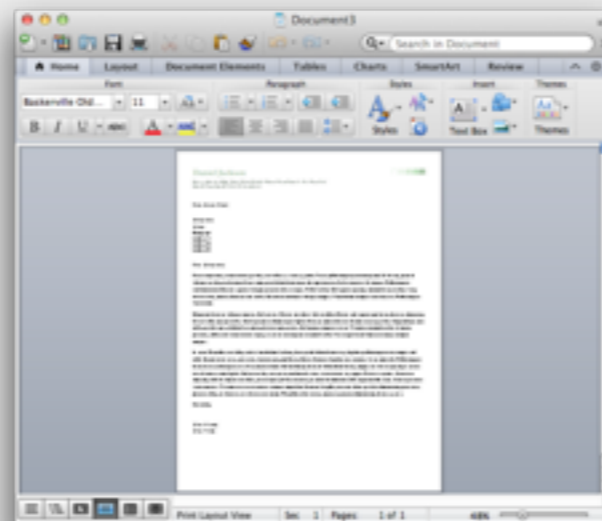

Paragraph
Format
Style

Twitter



Tweet
Hashtag
Following

Photoshop



PixelMap
Layer/Mask
Adjustment

concepts define classes

concepts define classes

```
44 -- approaches, not satisfying: surely something essential-
45
46 Take a step back: concepts-
47 -- example: Microsoft Word: font and Co-
48 -- where concepts come from-
49 -- implications of concepts-
50 -- how concepts distinguish apps (Word from LaTeX) and app classes (Word from [old])
51 -- what's software made of? concepts-
52
53 Towards a theory of concepts-
54 -- what's a concept?
55 state machine of user example-
56 abstract ideas, usually structural, explains behavior-
57 can explain with an operational principle without referring to purpose-
58 more complex examples: styles, alias, drag, tagging, selection in Ps
59 in all cases the concept does not fulfill a function directly-
60
61 -- granularity-
62 smallest concept that's a functionality increment-
63 eg. can have layer without mask-
64 but may choose to group into larger concept-
65
66 -- dependence-
67 concepts have dependences based on functional subsets-
68 what's the point of this?
69
70 -- criteria: compelling, coherent, controllable (de-coupled), general (complete, consistent),
71 familiar (conventional)-
72
73 -- one slide and a pro and con example for each?
74
75 -- a UE notion about it being represented well?
76 -- compelling: user facing, one motivating purpose, and an operational principle; it's about the
77 idea, not the realization-
78 -- fit for purpose: means they actually work (cf. scikit)-
79 -- familiar: obvious
80 -- independent: orthogonal-
81 -- coherent: unlike compelling, it's about the realization; means you can predict once you
82 understand a bit-
83 -- maybe means you expect them to fit together?
84 definition in Mac doesn't have meta data-
85 typeface variants in InDesign don't correspond to italic and bold-
86 pixel width in CSS doesn't correspond to pixels-
87 hiding in Google forms doesn't prevent publication of data-
88 conversation in Apple Mail: can't predict what will happen with delete or move or many other
89 operations; too complex and brittle-
90 -- complete: with respect to other concepts, e.g. CSS settings-
91 -- consistent: e.g., filters vs rules in Mail: maybe subsume both UE criteria under this-
92 -- analyze Acrobat, in R, concepts aren't visible; in DR, they become visible, but they're not
93 general, so they're not understandable or familiar-
94
```

text editor

concepts define classes

```
44 -- approaches, not satisfying: surely something essential-
45
46 Take a step back: concepts-
47 -- example: Microsoft Word: font and Co-
48 -- where concepts come from-
49 -- implications of concepts-
50 -- how concepts distinguish apps (Word from LaTeX) and app classes (Word from [old])-
51 -- what's software made of? concepts-
52
53 Towards a theory of concepts-
54 -- what's a concept?-
55 state machine of lines+ example-
56 abstract ideas, usually structural, explains behavior-
57 can explain with an operational principle without referring to purpose-
58 more complex examples: style, alias, trash, tagging, selection in Ps
59 in all cases the concept does not fulfill a function directive-
60
61 -- granularity-
62 smallest concept that's a functionality increment-
63 eg. can have layer without mask-
64 but may choose to group into larger concept-
65
66 -- dependence-
67 concepts have dependences based on functional subsets-
68 what's the point of this?-
69
70 -- criteria: compelling, coherent, controllable (de-coupled), general (complete, consistent),
71 familiar (conventional)-
72
73 -- one slide and a pro and con example for each?-
74
75 -- a UI notion about UI being represented well?-
76 -- compelling: user facing, one motivating purpose, and an operational principle: it's about the
77 idea, not the realization-
78 -- fit for purpose: means they actually work (cf. scifits)-
79 -- familiar: obvious-
80 -- independent: orthogonal-
81 -- coherent: unlike compelling, it's about the realization; means you can predict once you
82 understand a bit-
83
84 -- maybe means you expect them to fit together?-
85 definition in Mac doesn't have meta data-
86 typeface variants in InDesign don't correspond to italic and bold-
87 pixel width in CSS doesn't correspond to pixels-
88 hiding in Google forms doesn't prevent publication of data-
89 conversation in Apple Mail: can't predict what will happen with delete or move or many other
90 operations; too complex and brittle)-
91
92 -- complete: with respect to other concepts, e.g. CSS settings-
93 -- consistent: e.g., filters vs rules in Mail: maybe subsume both UI criteria under this-
94 -- analyze Acrobat, in R, concepts aren't visible: in UI, they become visible, but they're not
95 general, so they're not understandable or familiar-
```

text editor

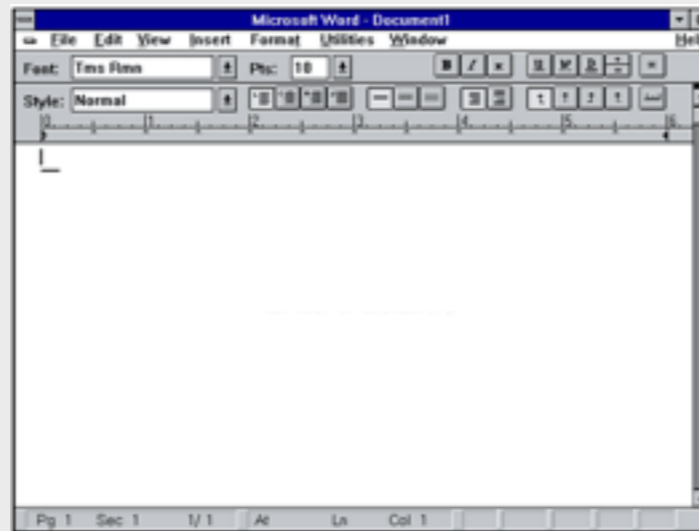

word processor

concepts define classes

```
44 - approaches, not satisfying: surely something essential-
45
46 Take a step back: concepts-
47 - example: Microsoft Word: font and Co-
48 - where concepts come from-
49 - implications of concepts-
50 - how concepts distinguish apps (Word from LaTeX) and app classes (Word from [old])
51 - what's software made of? concepts-
52
53 Towards a theory of concepts-
54 - what's a concept?
55 state machine of lines? example-
56 abstract ideas, usually structural, explains behavior-
57 can explain with an operational principle without referring to purpose-
58 more complex examples: style, alias, trash, tagging, selection in Po
59 in all cases the concept does not fulfill a function redirective-
60
61 - granularity-
62 smallest concept that's a functionality increment-
63 eg. can have layer without mask-
64 but may choose to group into larger concept-
65
66 - dependence-
67 concepts have dependences based on functional subsets-
68 what's the point of this?
69
70 - criteria: compelling, coherent, controllable (de-coupled), general (complete, consistent),
71 familiar (conventional)-
72
73 - one slide and a pro and con example for each?
74
75 - a UI notion about it being represented well?
76 - compelling: user facing, one motivating purpose, and an operational principle: it's about the
77 idea, not the realization-
78 - fit for purpose: means they actually work (cf. scifits)-
79 - familiar: obvious-
80 - independent: orthogonal-
81 - coherent: unlike compelling, it's about the realization; means you can predict once you
82 understand a bit-
83
84 so maybe means you expect them to fit together?
85 definition in Mac doesn't have meta data-
86 typeface variants in InDesign don't correspond to italic and bold-
87 pixel width in CSS doesn't correspond to pixels-
88 hiding in Google forms doesn't prevent publication of data-
89 conversation in Apple Mail can't predict what will happen with delete or move or many other
90 operations; too complex and brittle)-
91
92 - complete: with respect to other concepts, e.g. USB settings-
93 - consistent: e.g., filters vs rules in Mail; maybe subsume both UI criteria under this-
94 - analyze Acrobat, in S, concepts aren't visible; in UI, they become visible, but they're not
95 general, so they're not understandable or familiar-
96
```

text editor



word processor

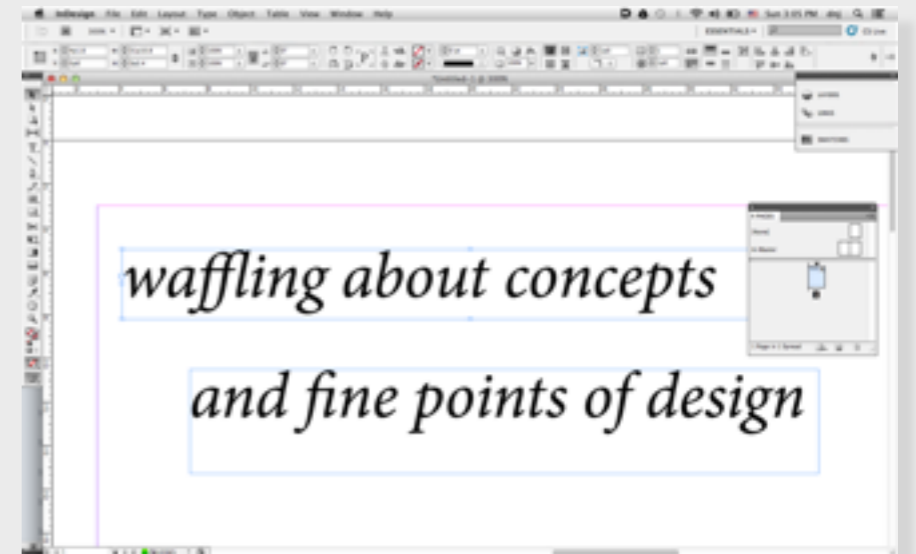

desktop publishing app

concepts define classes

```
44 -- approaches, not satisfying: surely something essential-
45
46 Take a step back: concepts-
47 -- example: Microsoft Word: font and Co-
48 -- where concepts come from-
49 -- implications of concepts-
50 -- how concepts distinguish apps (Word from LaTeX) and app classes (Word from [old])
51 -- what's software made of? concepts-
52
53 Towards a theory of concepts-
54 -- what's a concept?
55 state machine of lines? example-
56 abstract ideas, usually structural, explains behavior-
57 can explain with an operational principle without referring to purpose-
58 more complex examples: style, alias, trash, tagging, selection in Po
59 in all cases the concept does not fulfill a function redirective-
60
61 -- granularity-
62 smallest concept that's a functionality increment-
63 eg. can have layer without mask
64 but may choose to group into larger concept-
65
66 -- dependence-
67 concepts have dependences based on functional subsets-
68 what's the point of this?
69
70 -- criteria: compelling, coherent, controllable (de-coupled), general (complete, consistent),
71 familiar (conventional)-
72
73 -- one slide and a pro and con example for each?
74
75 -- a UE notion about it being represented well?
76 -- compelling: user facing, one motivating purpose, and an operational principle: it's about the
77 idea, not the realization-
78 -- fit for purpose: means they actually work (cf scifits)-
79 -- familiar: obvious-
80 -- independent: orthogonal-
81 -- coherent: unlike compelling, it's about the realization; means you can predict once you
82 understand a bit-
83
84 -- maybe means you expect them to fit together?
85 definition in Mac doesn't have meta data-
86 typeface variants in InDesign don't correspond to italic and bold-
87 pixel width in CSS doesn't correspond to pixels-
88 hiding in Google forms doesn't prevent publication of data-
89 conversation in Apple Mail can't predict what will happen with delete or move or many other
90 operations; too complex and brittle)-
91
92 -- complete: with respect to other concepts, e.g. USB settings-
93 -- consistent: e.g., filters vs rules in Mail; maybe subsume both UE criteria under this-
94 -- analyze Acrobat, in S, concepts aren't visible; in DR, they become visible, but they're not
95 general, so they're not understandable or familiar-
```

text editor
line
buffer



word processor

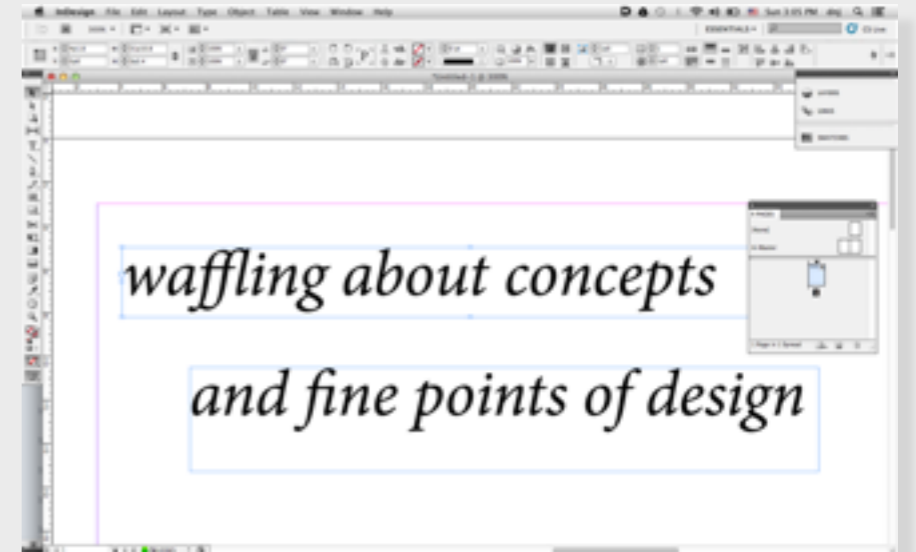

desktop publishing app

concepts define classes



text editor
line
buffer



word processor
paragraph
format
style

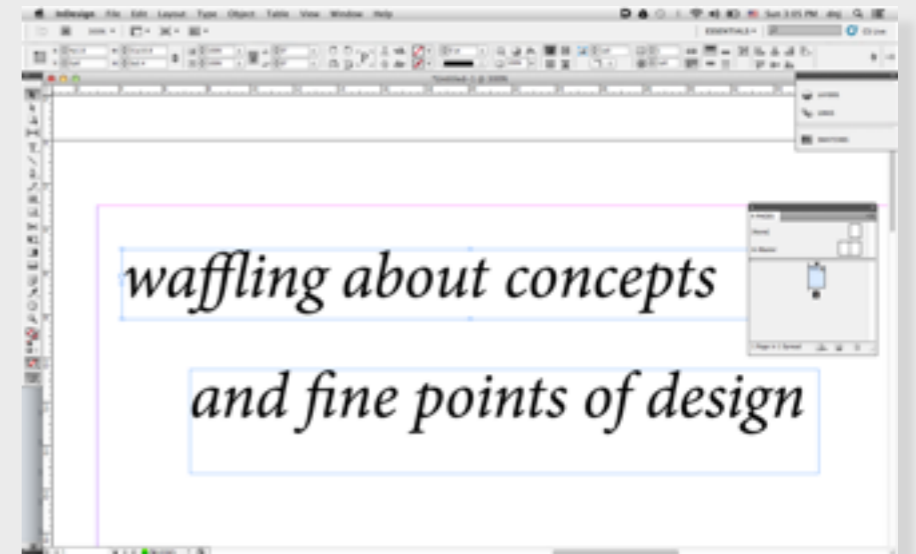

desktop publishing app

concepts define classes



text editor
line
buffer

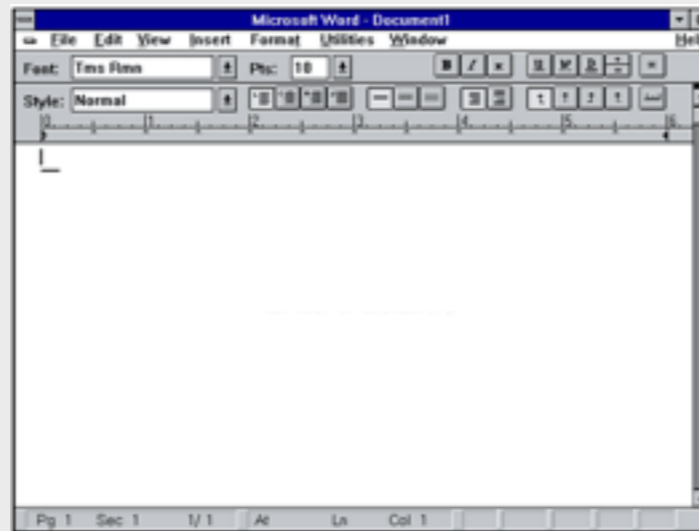

word processor
paragraph
format
style

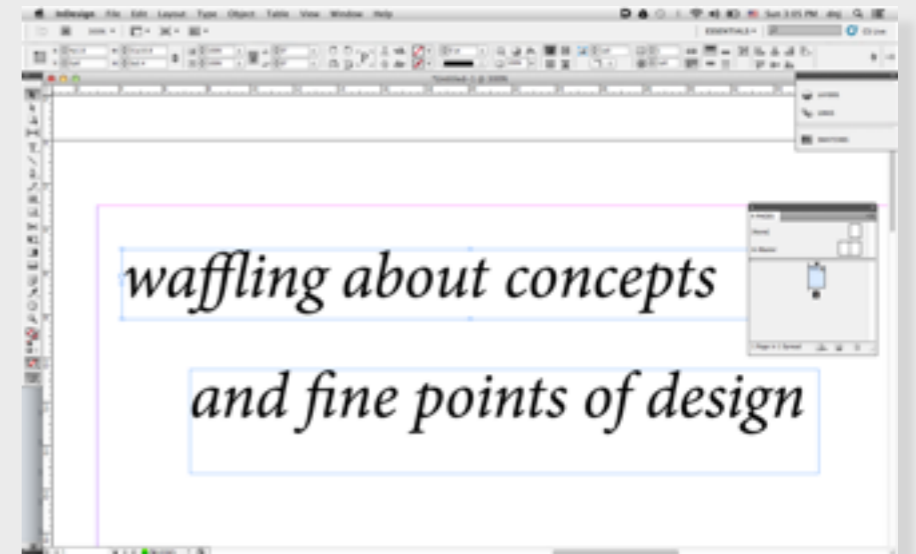

desktop publishing app
stylesheet
text flow
page template

concepts define classes



text editor
line
buffer



word processor
paragraph
format
style

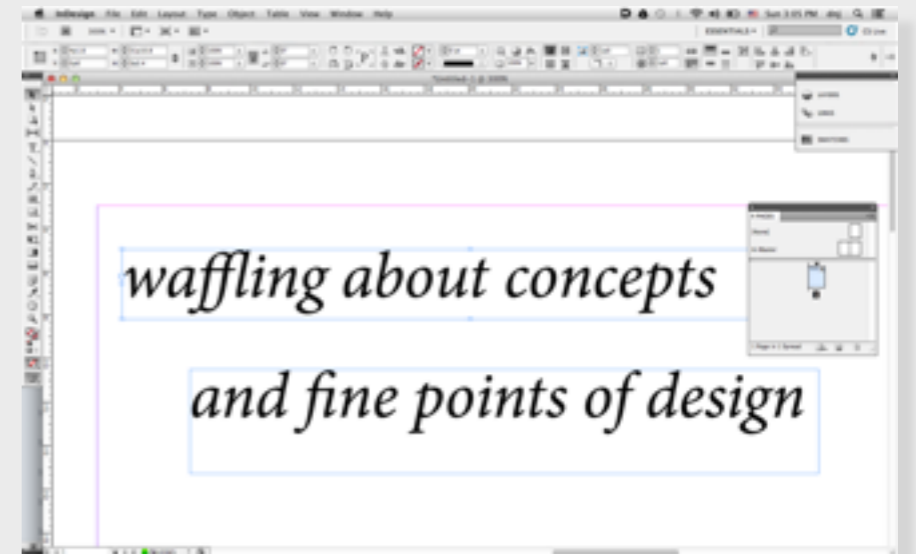

desktop publishing app
stylesheet
text flow
page template

jamonh

Oct 22, 2013 7:19 PM

Just upgraded to the new Pages and can't find a way to link text boxes anymore like

<http://www.macobserver.com/tmo/article/pages-linking-text-boxes>

Am I missing something, or is it really not possible anymore?

where are Word's concepts from?

where are Word's concepts from?



where are Word's concepts from?



Charles Simonyi: brought key concepts to Word from Xerox PARC

rich concepts have long journeys

rich concepts have long journeys

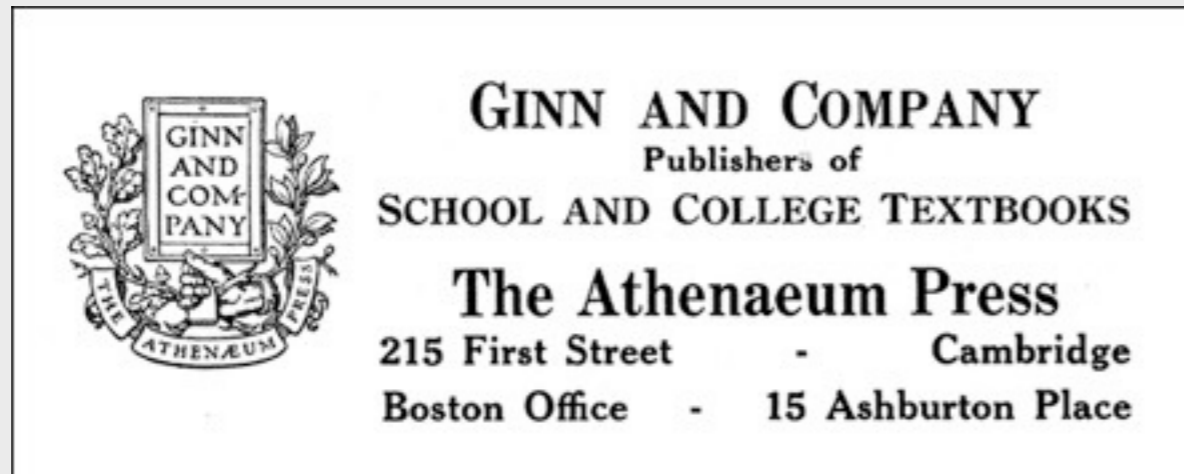

Ginn & Co, since 1868

rich concepts have long journeys

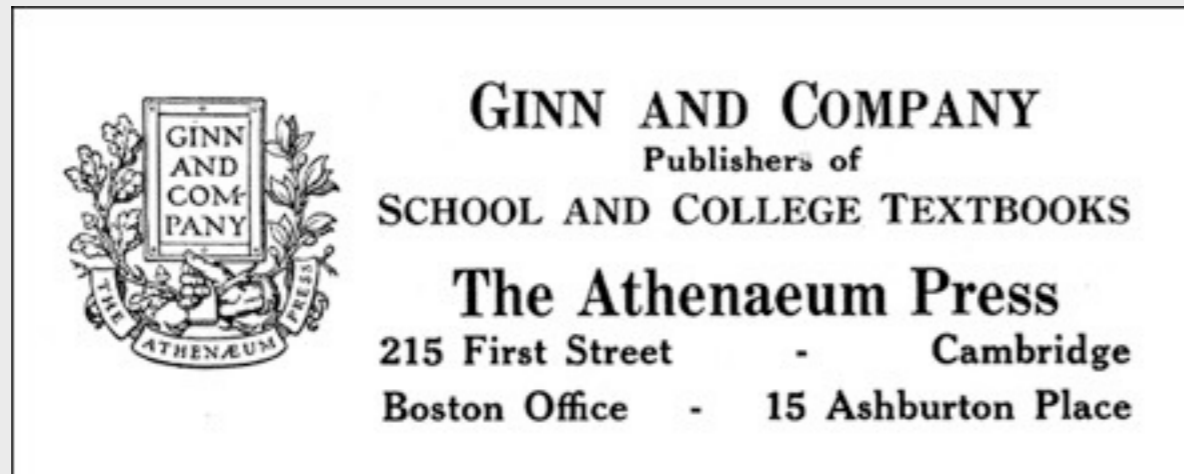

Ginn & Co, since 1868

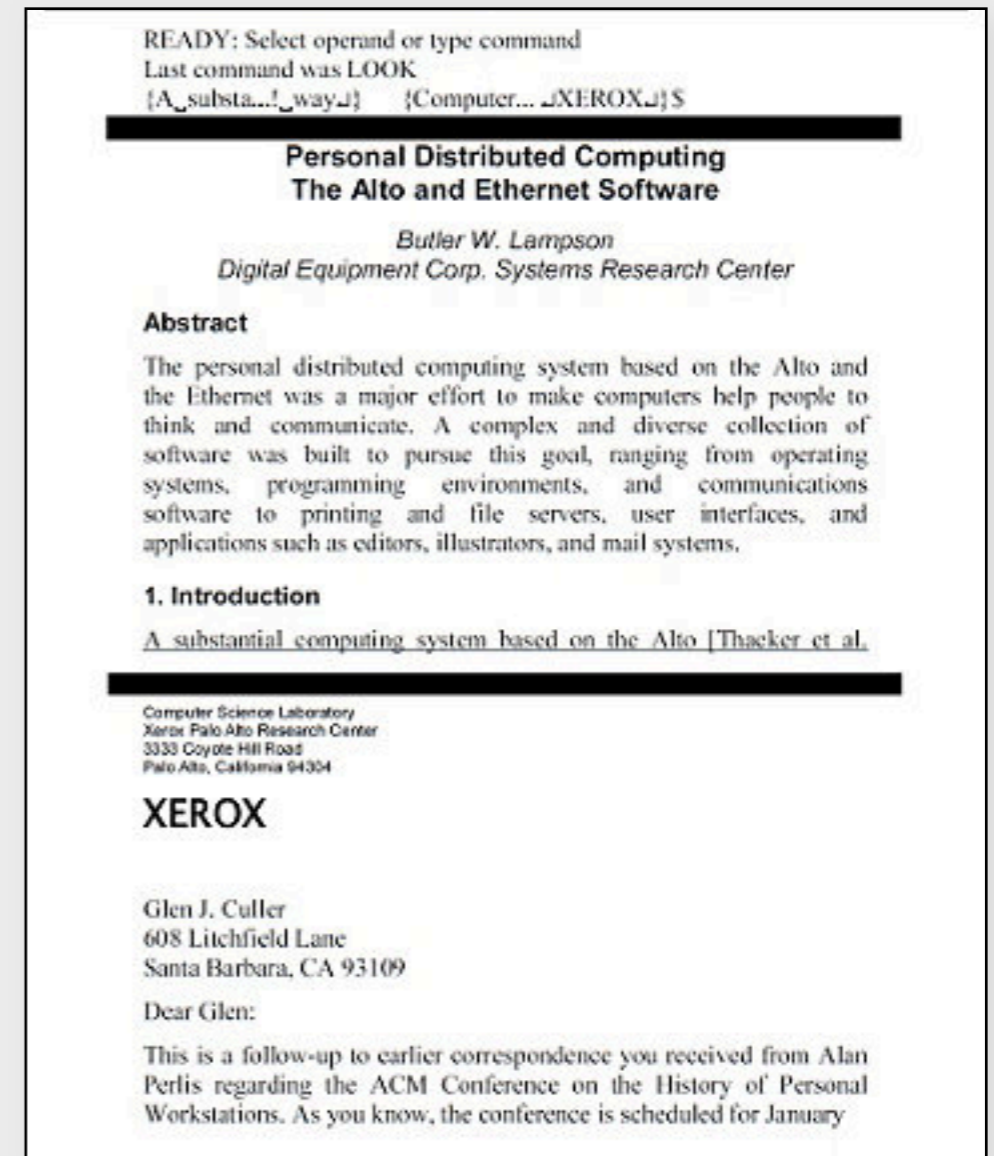

Bravo, 1974

rich concepts have long journeys

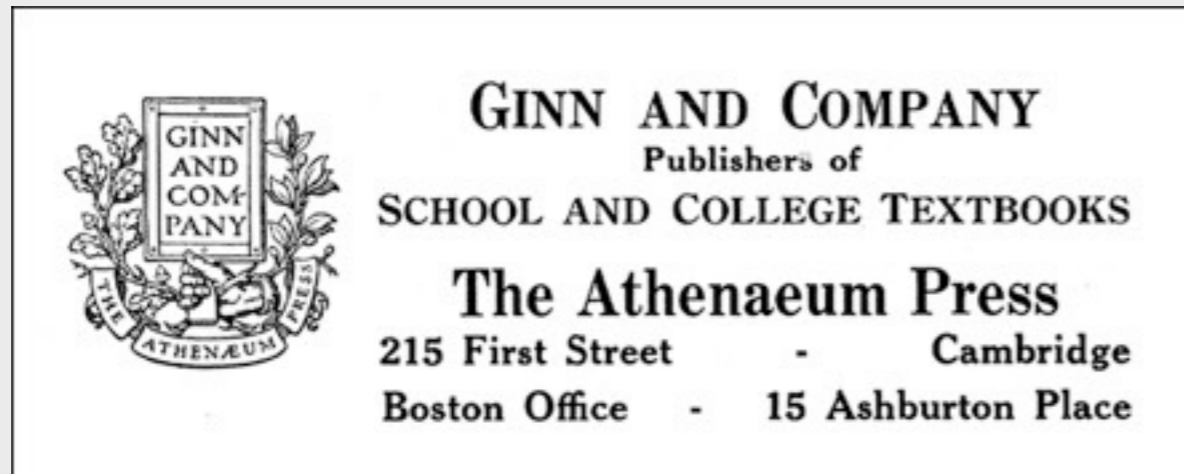

Ginn & Co, since 1868

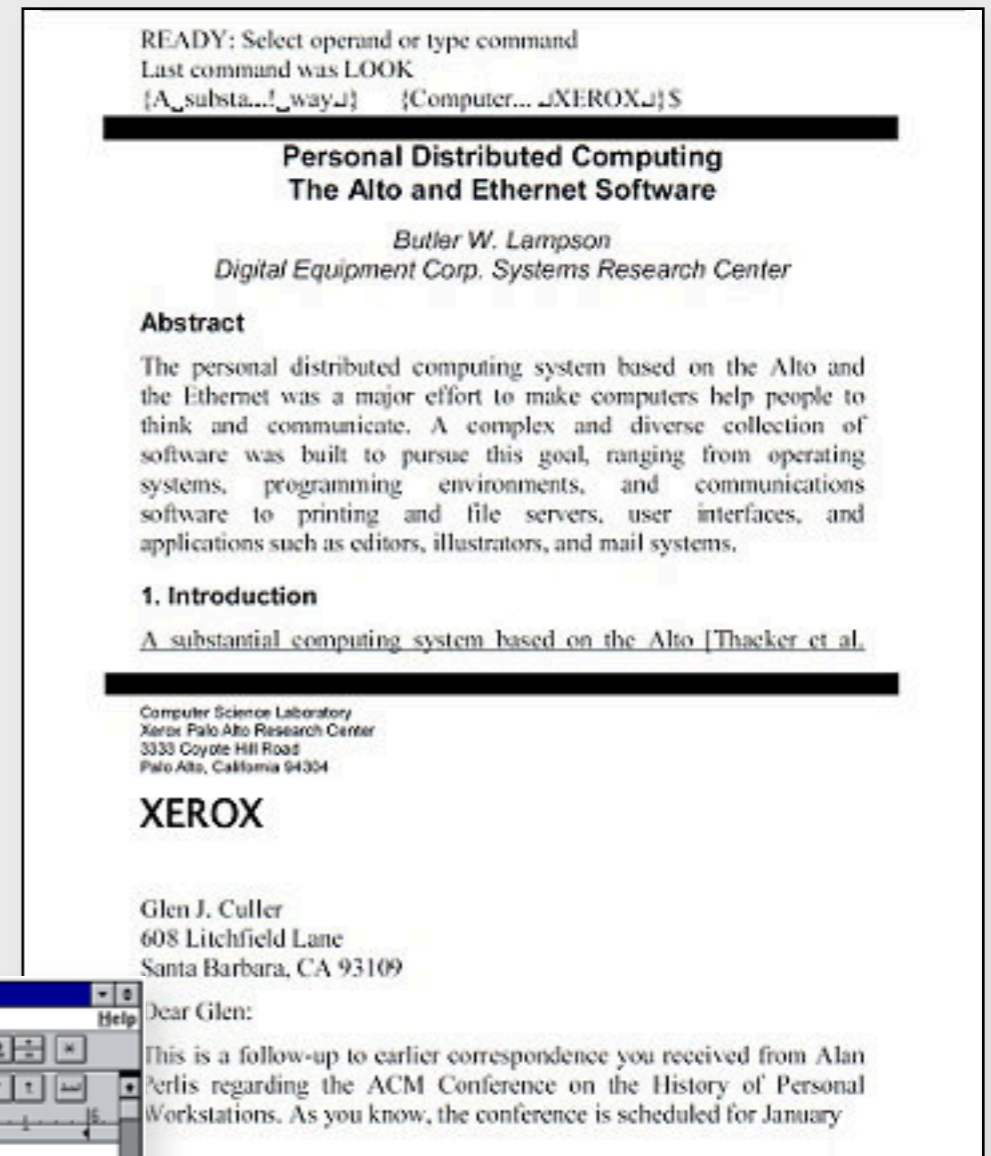

Bravo, 1974

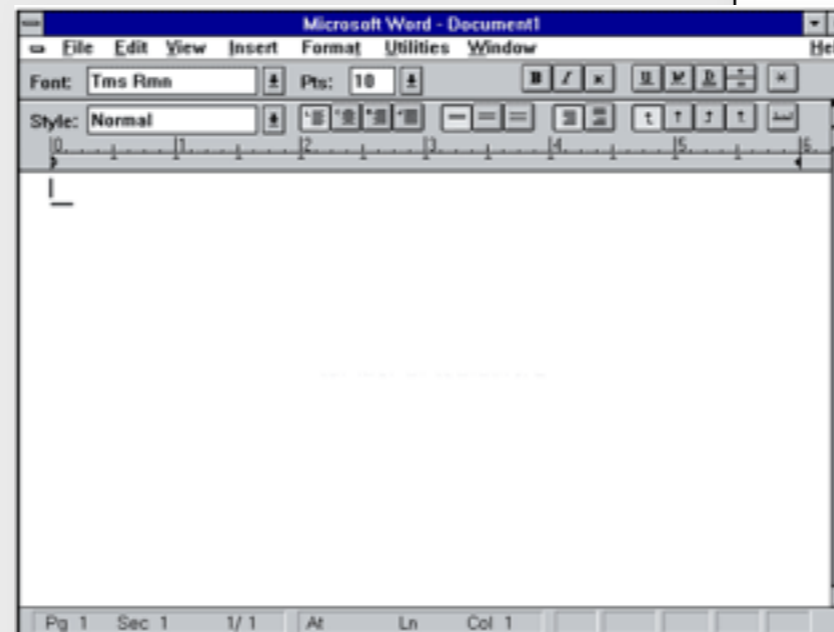

Microsoft Word, 1983

rich concepts have long journeys

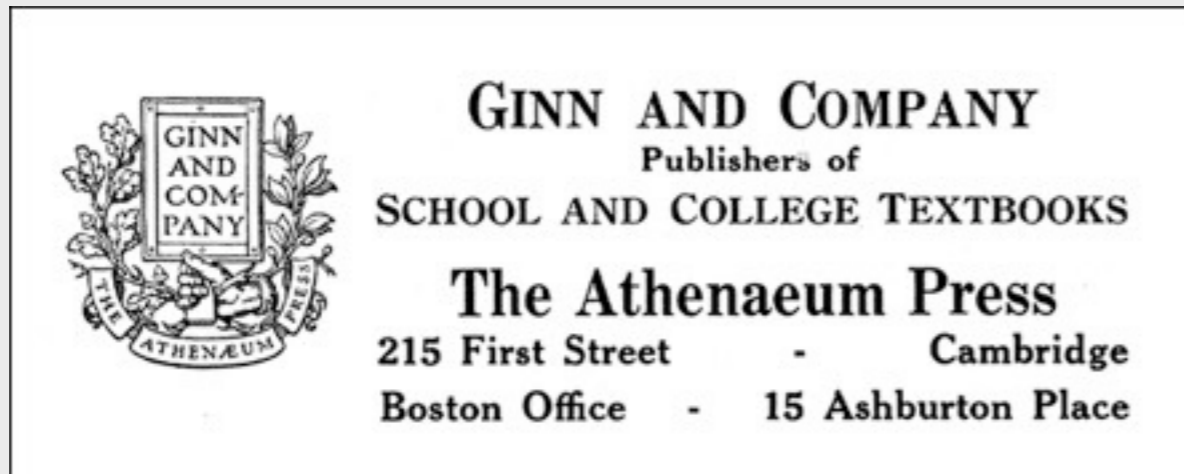

Ginn & Co, since 1868

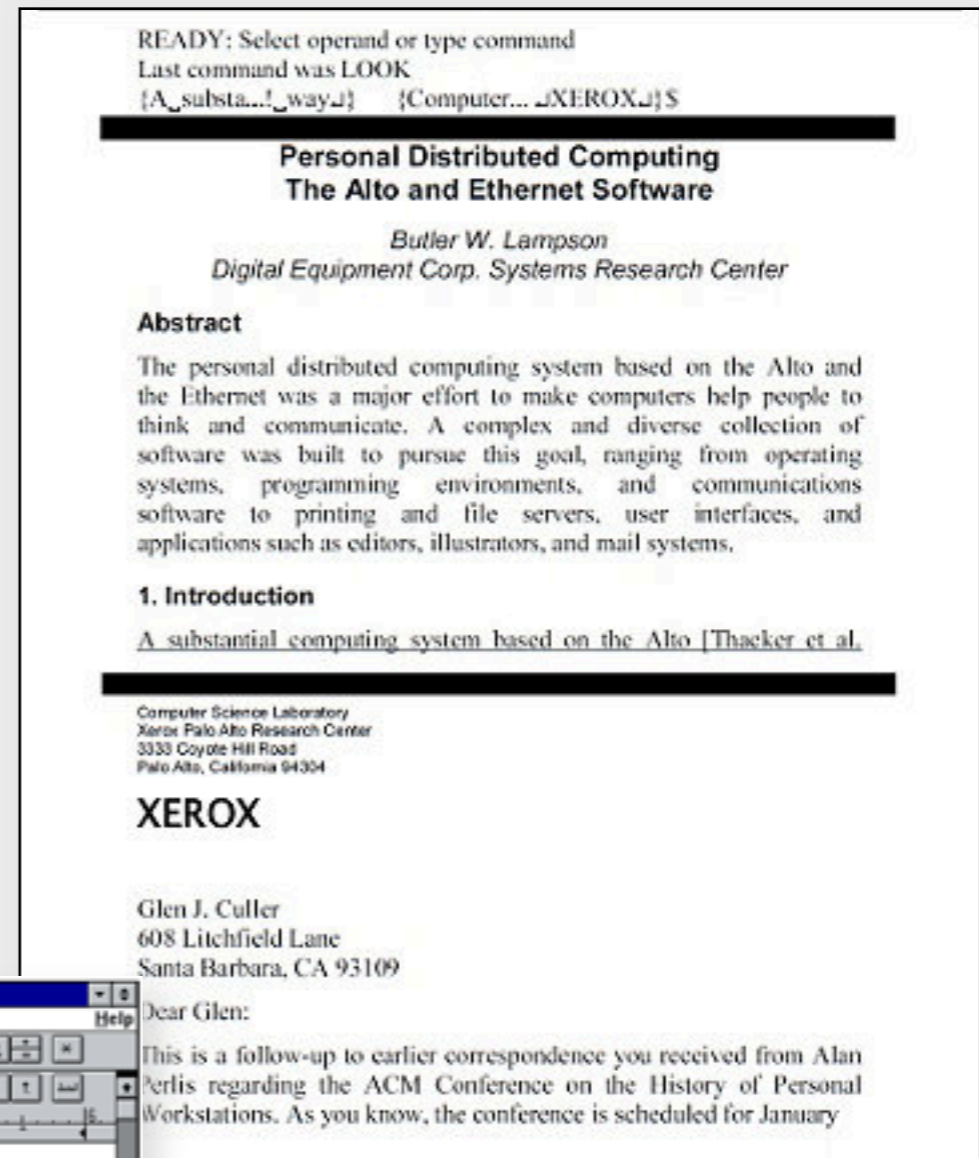

Bravo, 1974



Apple Pages, 2005

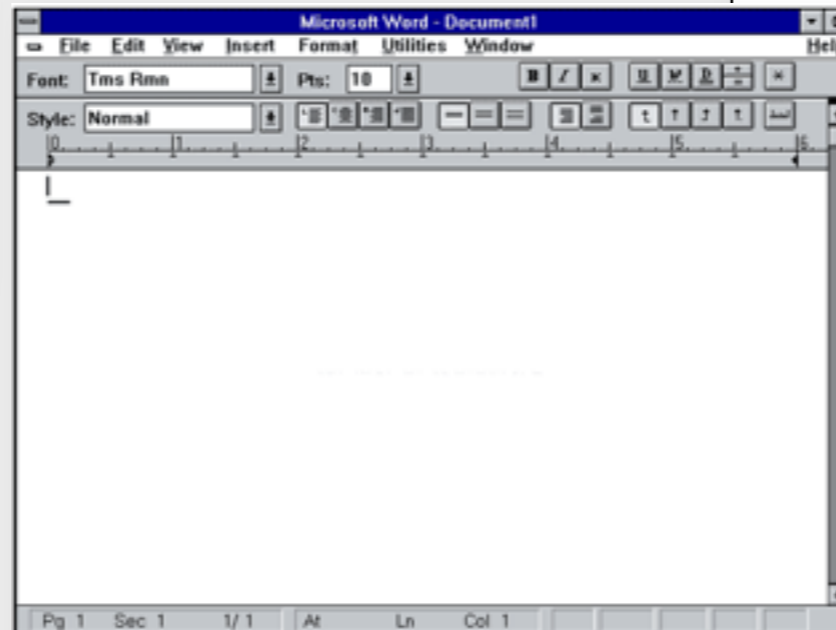

Microsoft Word, 1983

kinds of concept

kinds of concept

given concepts

electoral vote

reservation

social security number

calendar event

kinds of concept

given concepts

electoral vote

reservation

social security number

calendar event

instrumental concepts

hashtag

label

friend

follower

kinds of concept

given concepts

electoral vote

reservation

social security number

calendar event

instrumental concepts

hashtag

label

friend

follower

enabling concepts

relative reference

public key

layer mask

conference call

kinds of concept

even these were
invented

given concepts

electoral vote

reservation

social security number

calendar event

instrumental concepts

hashtag

label

friend

follower

enabling concepts

relative reference

public key

layer mask

conference call

kinds of concept

even these were
invented

given concepts

electoral vote

reservation

social security number

calendar event

analogical,
or new

instrumental concepts

hashtag

label

friend

follower

enabling concepts

relative reference

public key

layer mask

conference call

kinds of concept

even these were
invented

given concepts

electoral vote

reservation

social security number

calendar event

analogical,
or new

instrumental concepts

hashtag

label

friend

follower

solve a hard design
problem

enabling concepts

relative reference

public key

layer mask

conference call

how
to sketch
a concept

how would you explain this?

how would you explain this?



the operational principle

a way to explain a concept

the operational principle

a way to explain a concept

an archetypal scenario

separates essential from accidental aspects

shows how purpose is fulfilled

by combination of user & system actions

the operational principle

a way to explain a concept

an archetypal scenario

separates essential from accidental aspects

shows how purpose is fulfilled

by combination of user & system actions



“**if** you pull a tab out, **then** when that time slot comes around, the light will go on”

the operational principle

a way to explain a concept

an archetypal scenario

separates essential from accidental aspects
shows how purpose is fulfilled
by combination of user & system actions



Michael Polanyi



“if you pull a tab out, **then** when that time slot comes around, the light will go on”



“**if** you pull a tab out, **then** when that time slot comes around, the light will go on”



“if you pull a tab out, **then** when that time slot comes around, the light will go on”

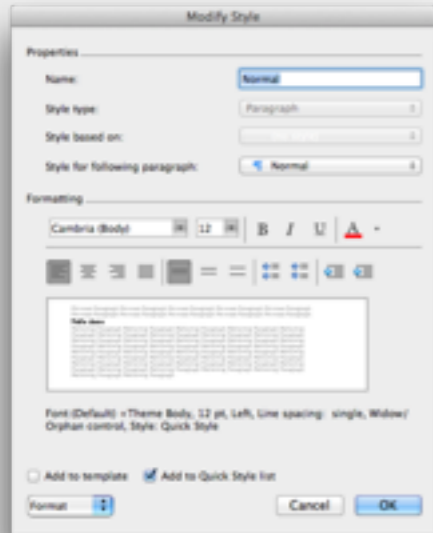

“if you change a style’s format, **then** all paragraphs of that style will change format accordingly”



“if you pull a tab out, **then** when that time slot comes around, the light will go on”



“if you change a style’s format, **then** all paragraphs of that style will change format accordingly”



“if you tag a photo, **then** all friends of the person tagged will be able to see the photo”



“if you pull a tab out, **then** when that time slot comes around, the light will go on”



“if you change a style’s format, **then** all paragraphs of that style will change format accordingly”



“if you tag a photo, **then** all friends of the person tagged will be able to see the photo”

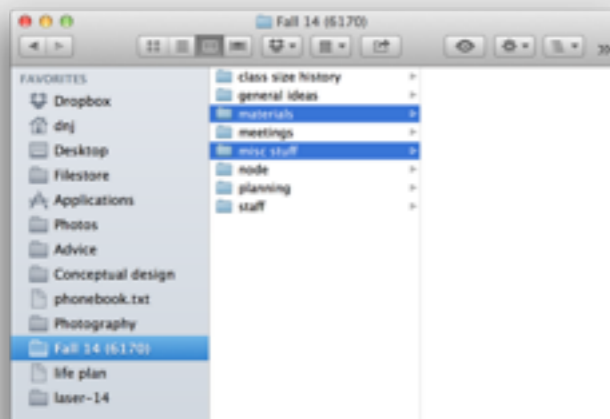

“if you select some files and they belong to a folder with keyboard focus, **then** pressing delete will move the files to the trash”

purposes, principles & misfits

purposes, principles & misfits

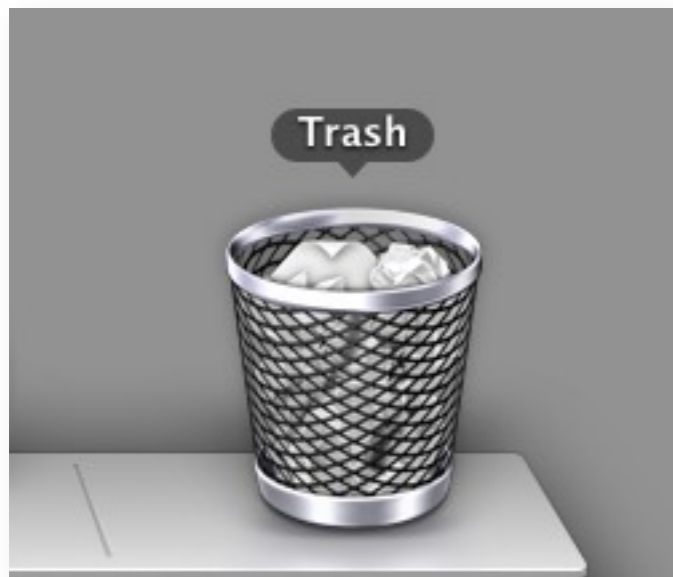

concept: trash

purposes, principles & misfits

purpose: allow undo of deletions

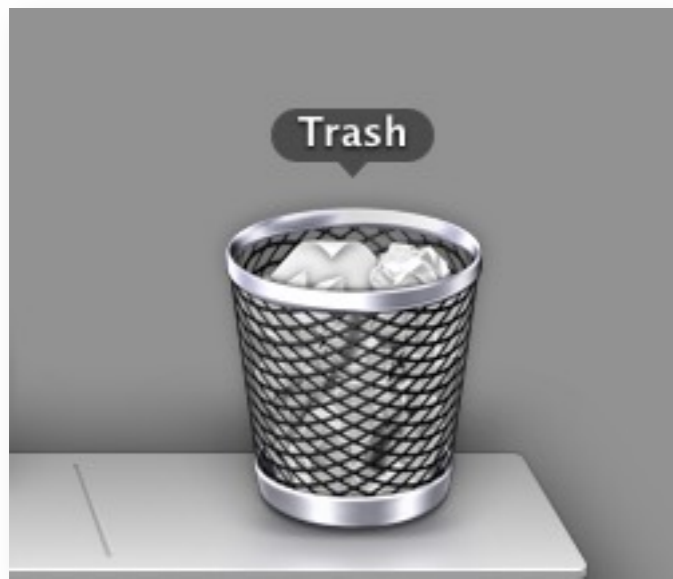

concept: trash

purposes, principles & misfits

purpose: allow undo of deletions

operational principle: if you delete a file, it moves to a special folder; you can restore from there, but emptying it removes contents for good (and makes space on disk)

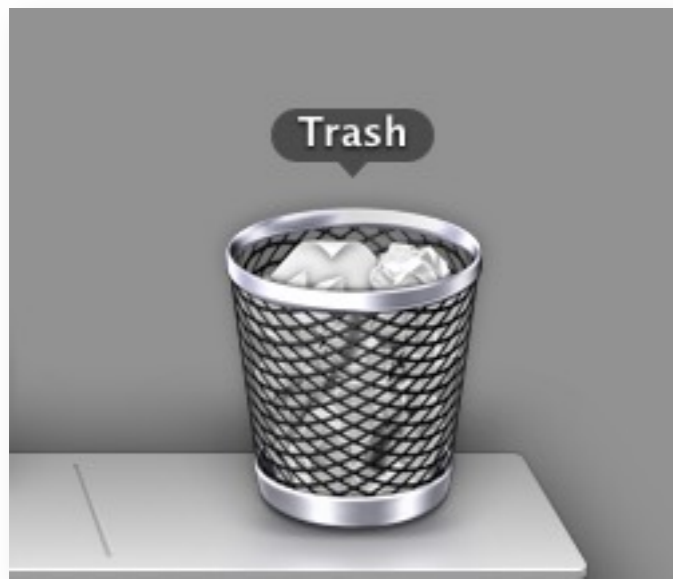

concept: trash

purposes, principles & misfits

purpose: allow undo of deletions

operational principle: if you delete a file, it moves to a special folder; you can restore from there, but emptying it removes contents for good (and makes space on disk)

misfit: if you delete a file on an external drive, you cannot reclaim the space until you empty the trash, but then you'll lose the ability to restore files deleted from the main drive

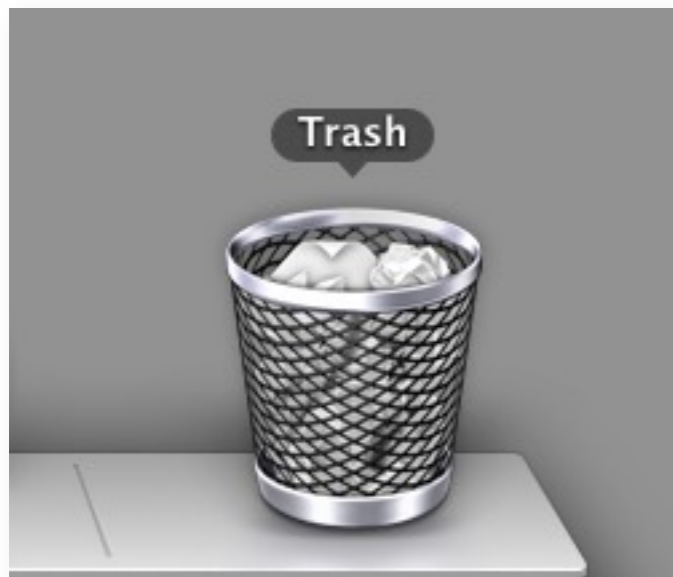

concept: trash

purposes, principles & misfits

purpose: allow undo of deletions

operational principle: if you delete a file, it moves to a special folder; you can restore from there, but emptying it removes contents for good (and makes space on disk)

misfit: if you delete a file on an external drive, you cannot reclaim the space until you empty the trash, but then you'll lose the ability to restore files deleted from the main drive

misfit: if you delete an old file and change your mind, you may not be able to find it again in the trash (if there are many deleted files and you forgot the file's name)

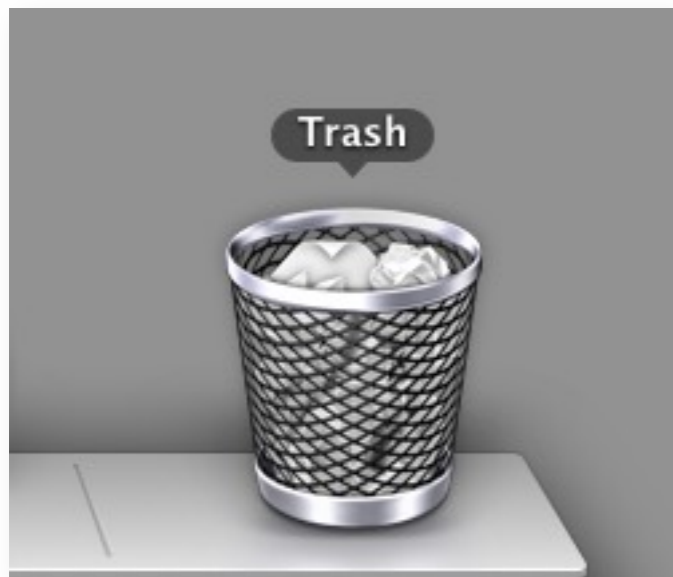

concept: trash

how
to model
a concept

example word styles

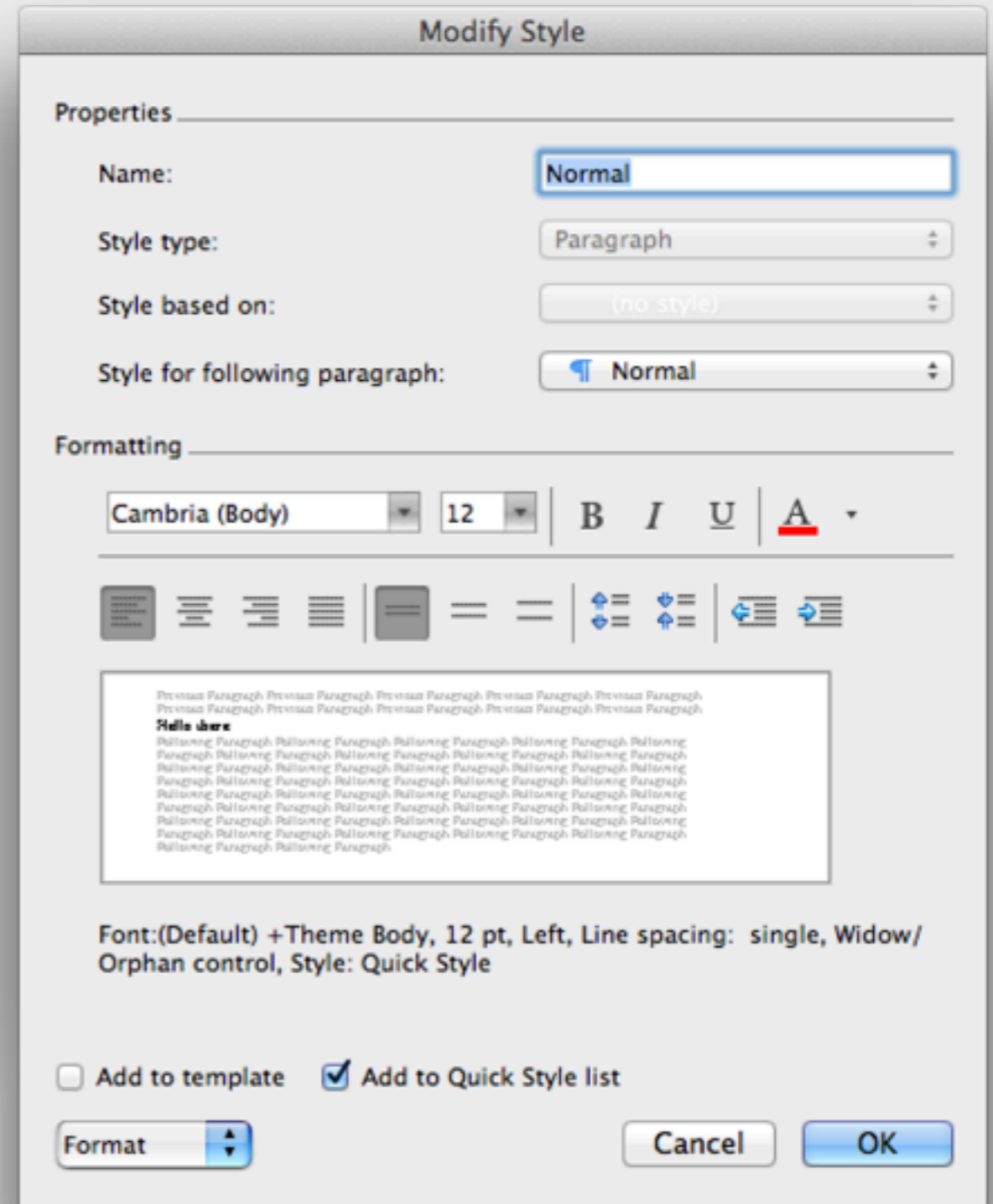
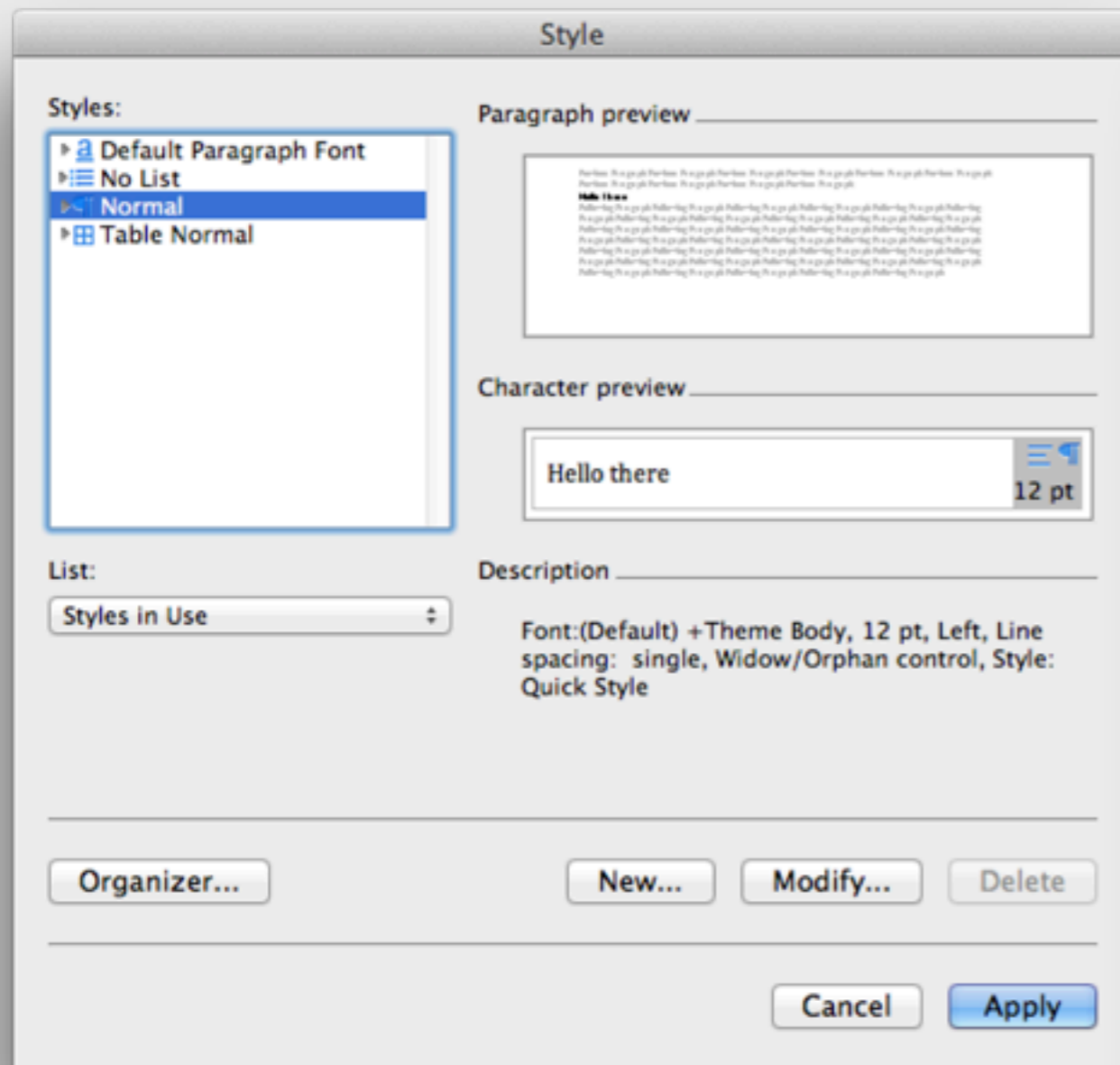

data model word styles

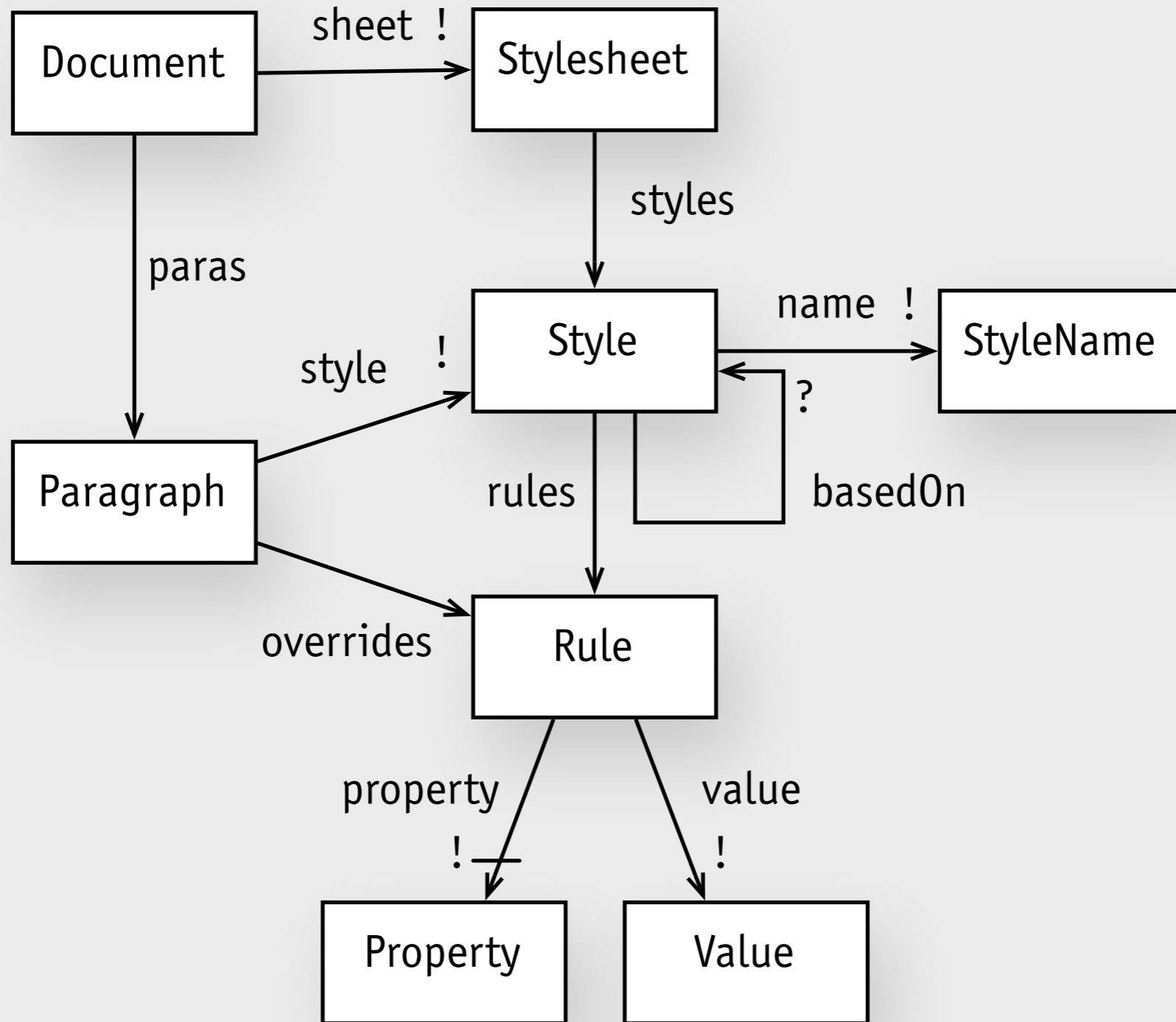

data model word styles

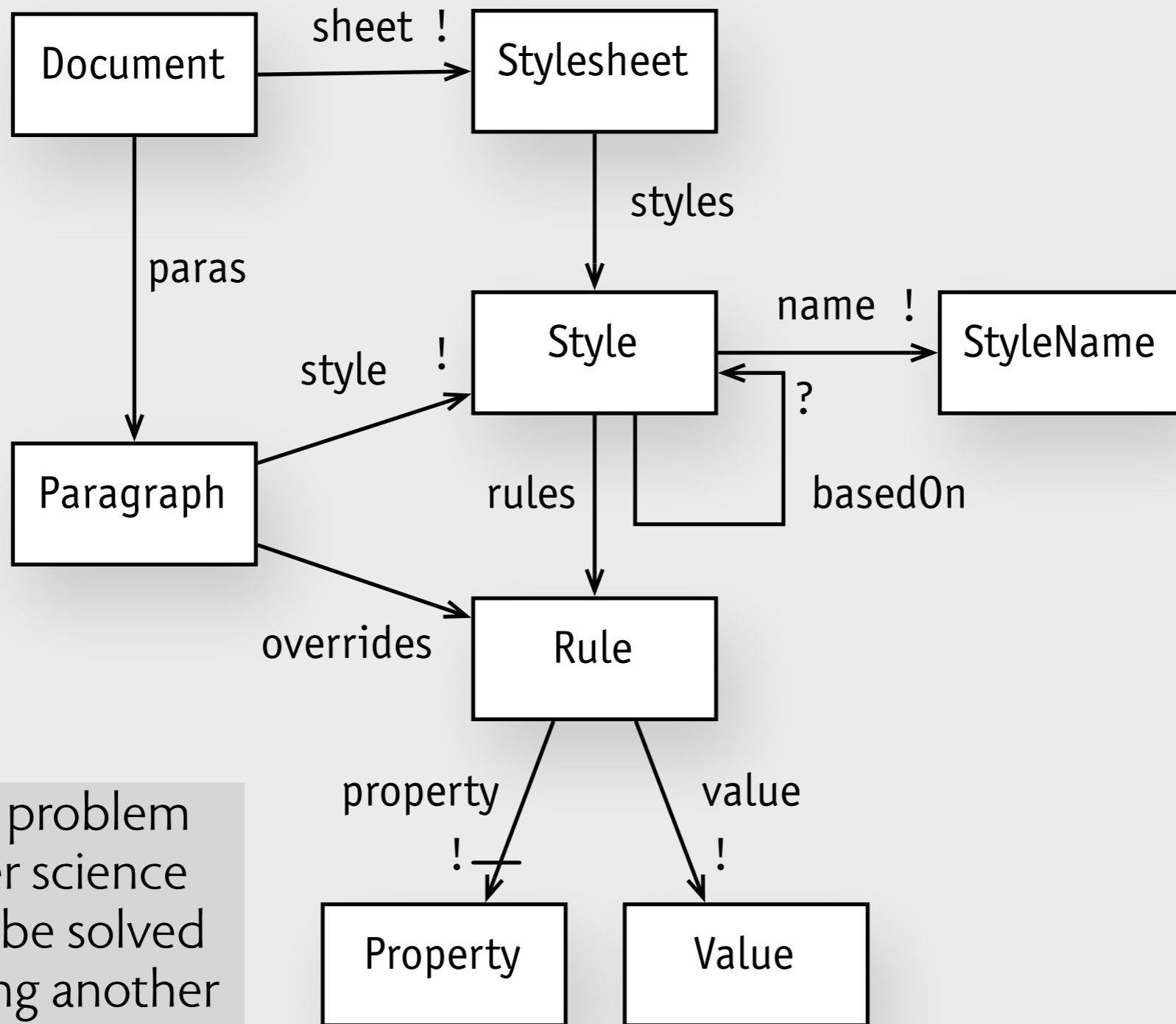

There is no problem
in computer science
that cannot be solved
by introducing another
level of indirection.
David Wheeler

data model word styles

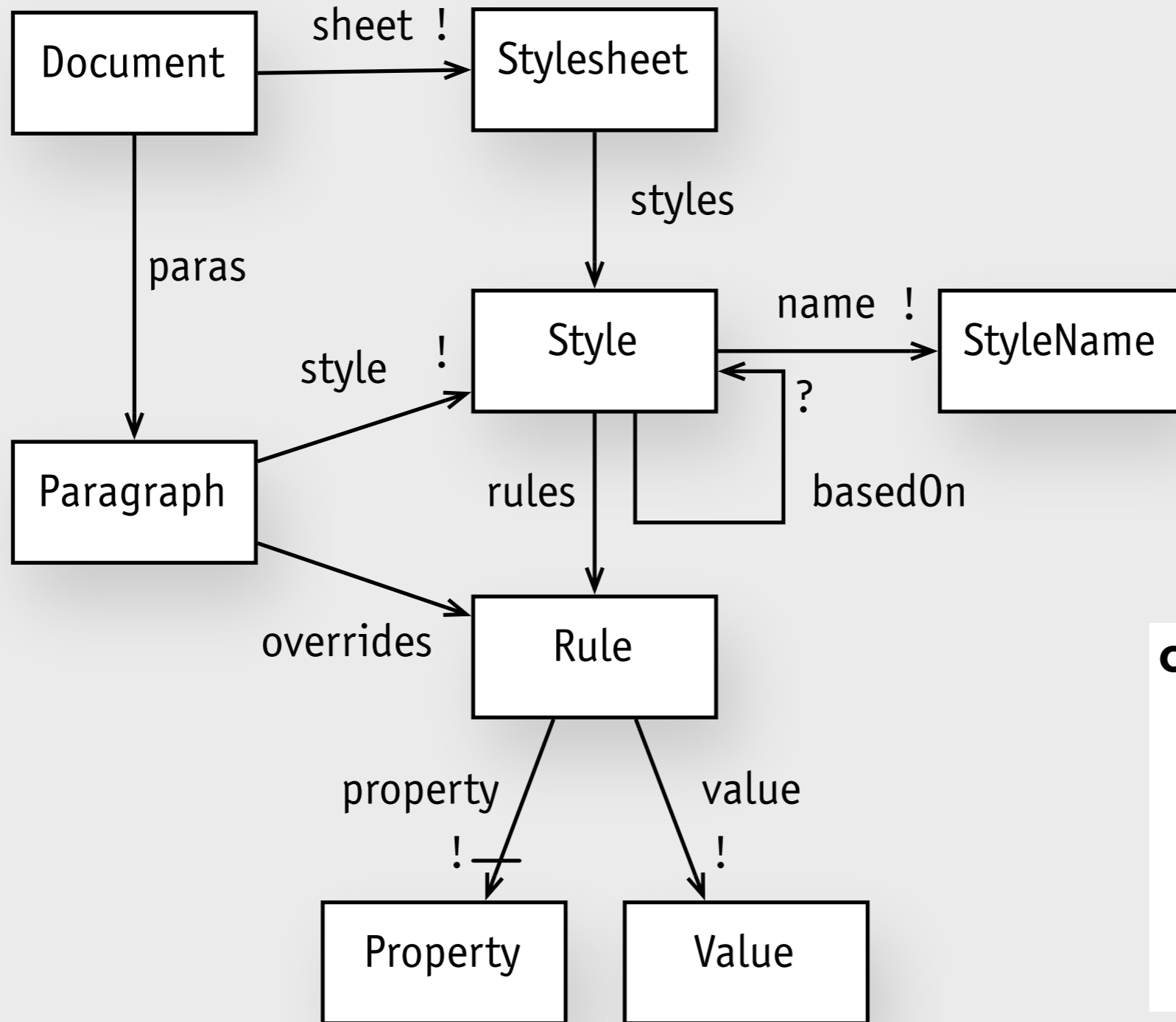

operations

- add
- delete
- modify
- update
- apply

concept dependences

concept dependences

$\langle c, c' \rangle \in \text{depends} \Leftrightarrow \forall a: \text{apps} \cdot c \in \text{concepts}(a) \Rightarrow c' \in \text{concepts}(a)$

concept dependences

$\langle c, c' \rangle \in \text{depends} \Leftrightarrow \forall a: \text{apps} \cdot c \in \text{concepts}(a) \Rightarrow c' \in \text{concepts}(a)$

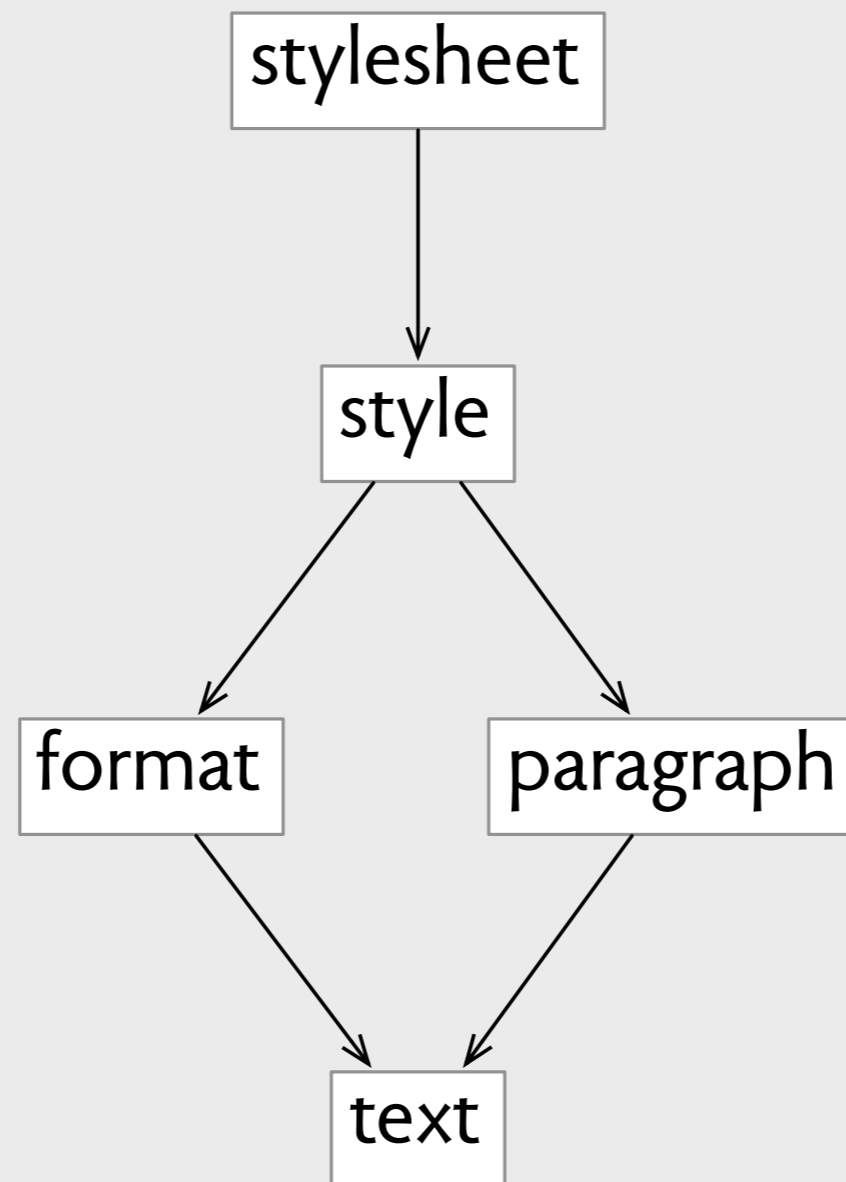

concept dependences

$\langle c, c' \rangle \in \text{depends} \Leftrightarrow \forall a: \text{apps} \cdot c \in \text{concepts}(a) \Rightarrow c' \in \text{concepts}(a)$

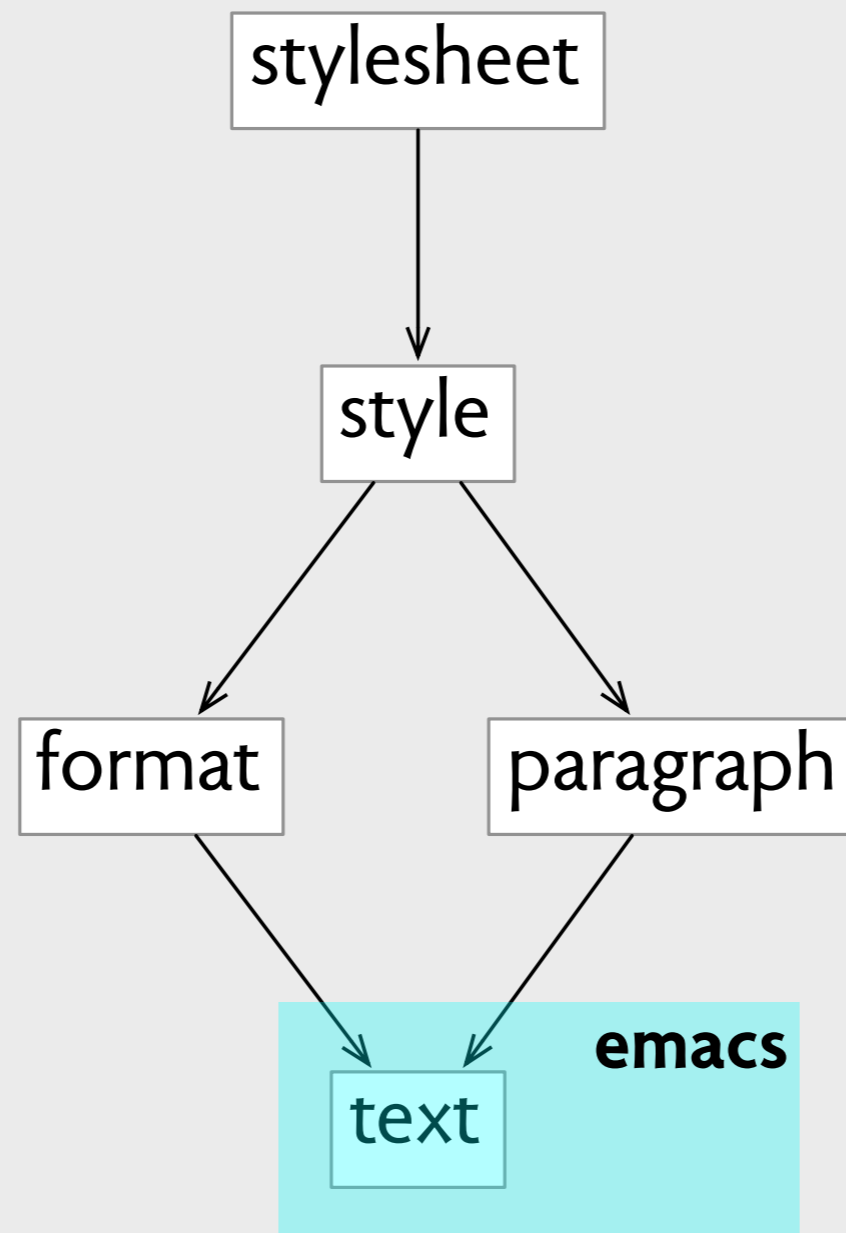

concept dependences

$\langle c, c' \rangle \in \text{depends} \Leftrightarrow \forall a: \text{apps} \cdot c \in \text{concepts}(a) \Rightarrow c' \in \text{concepts}(a)$

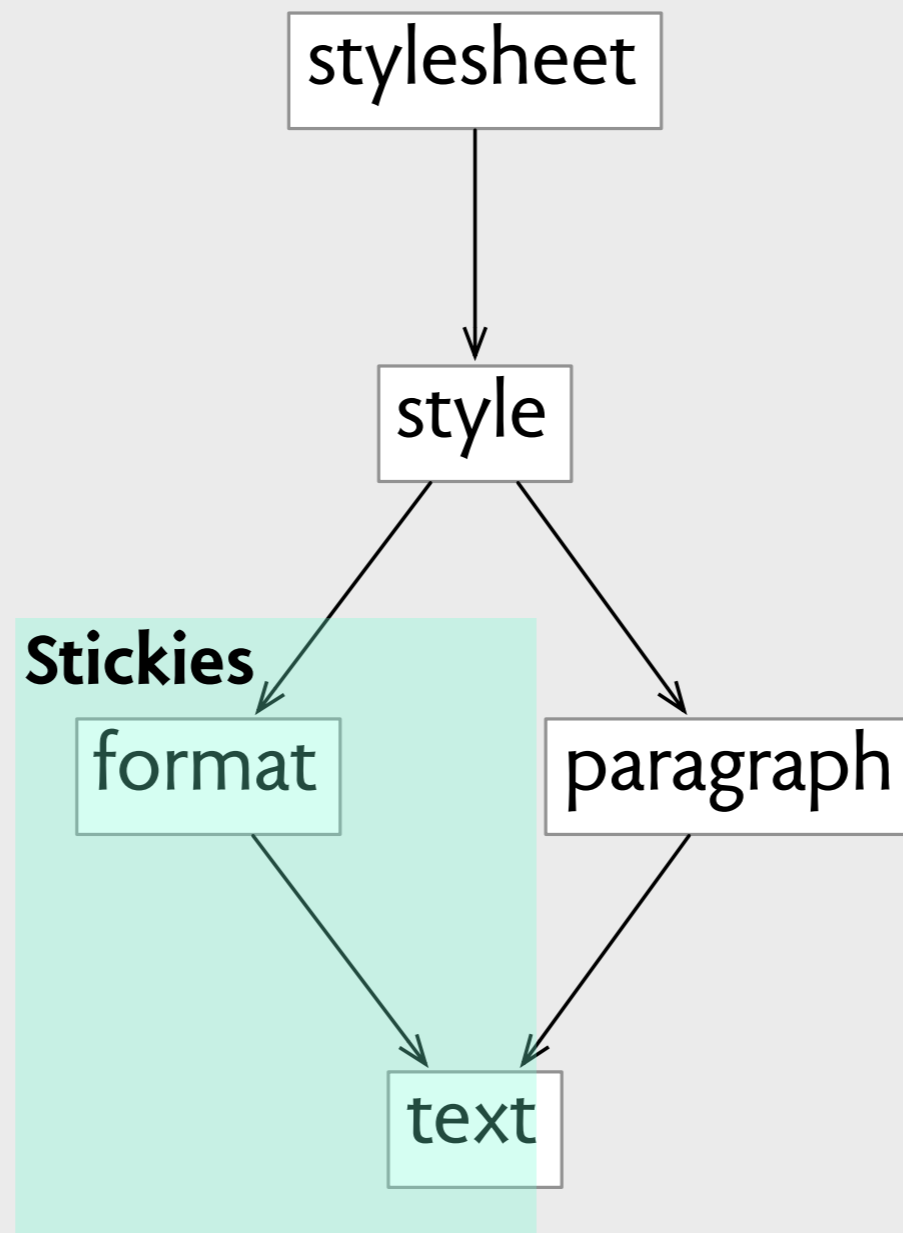

concept dependences

$\langle c, c' \rangle \in \text{depends} \Leftrightarrow \forall a: \text{apps} \cdot c \in \text{concepts}(a) \Rightarrow c' \in \text{concepts}(a)$

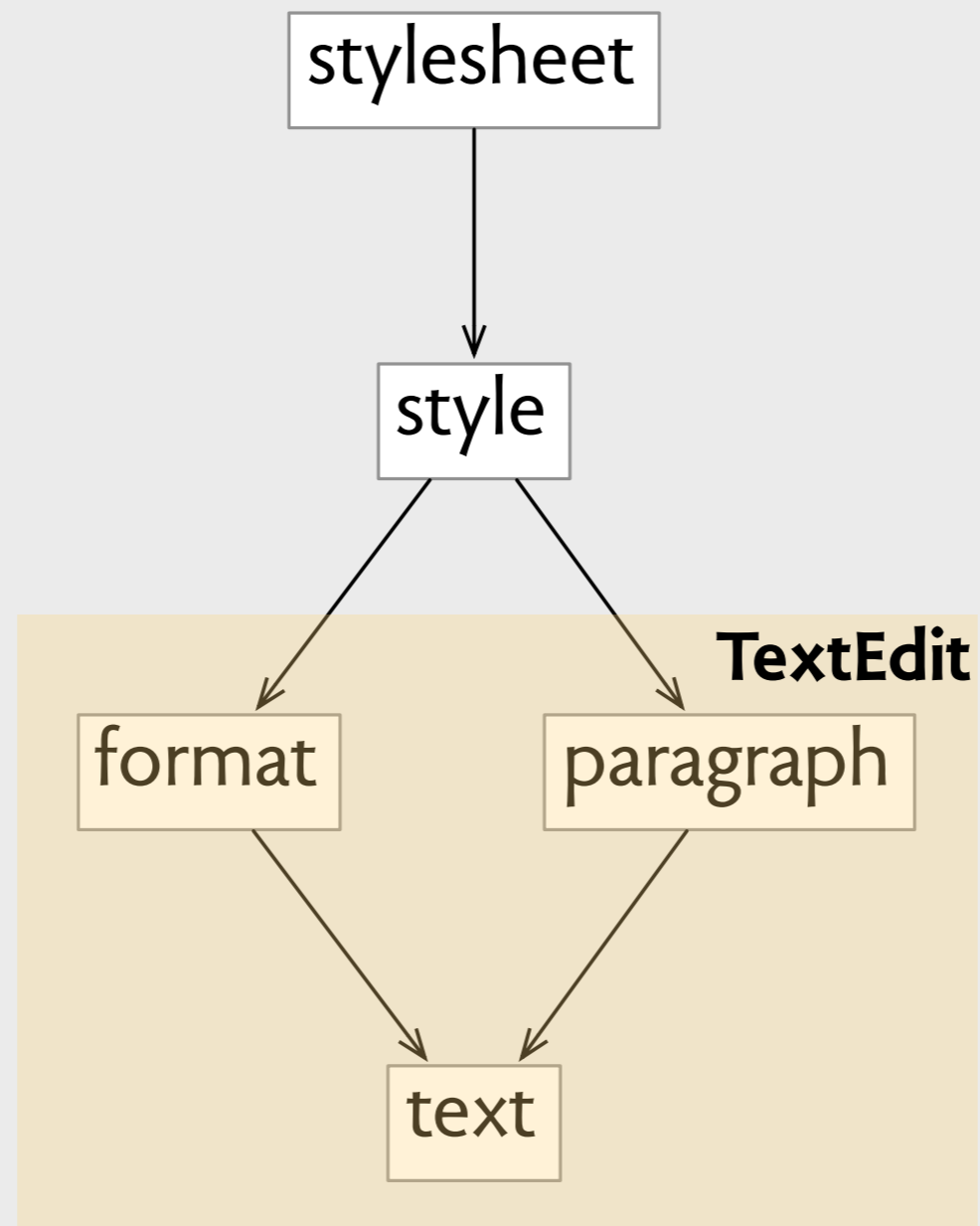

concept dependences

$\langle c, c' \rangle \in \text{depends} \Leftrightarrow \forall a: \text{apps} \cdot c \in \text{concepts}(a) \Rightarrow c' \in \text{concepts}(a)$

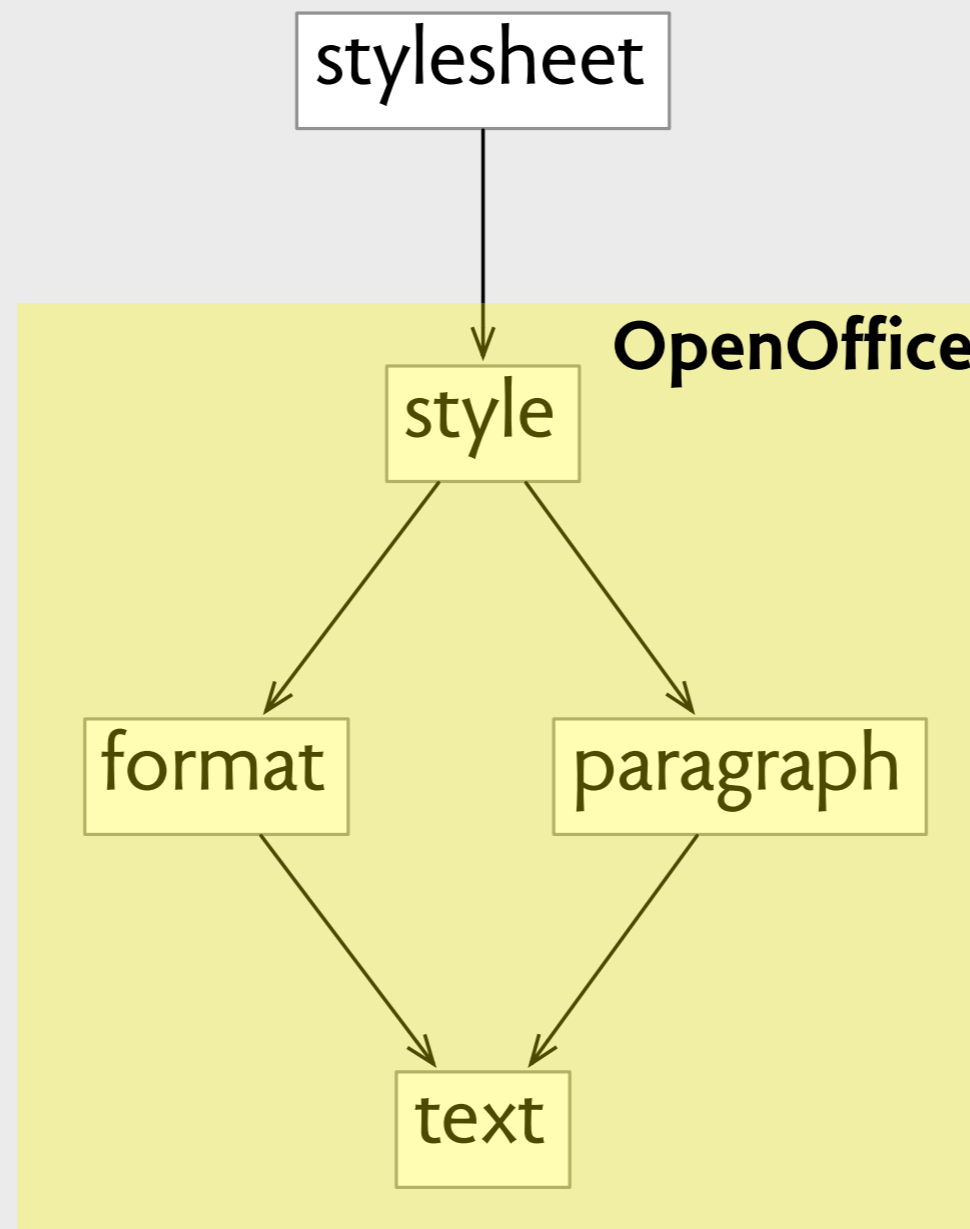

concept dependences

$\langle c, c' \rangle \in \text{depends} \Leftrightarrow \forall a: \text{apps} \cdot c \in \text{concepts}(a) \Rightarrow c' \in \text{concepts}(a)$

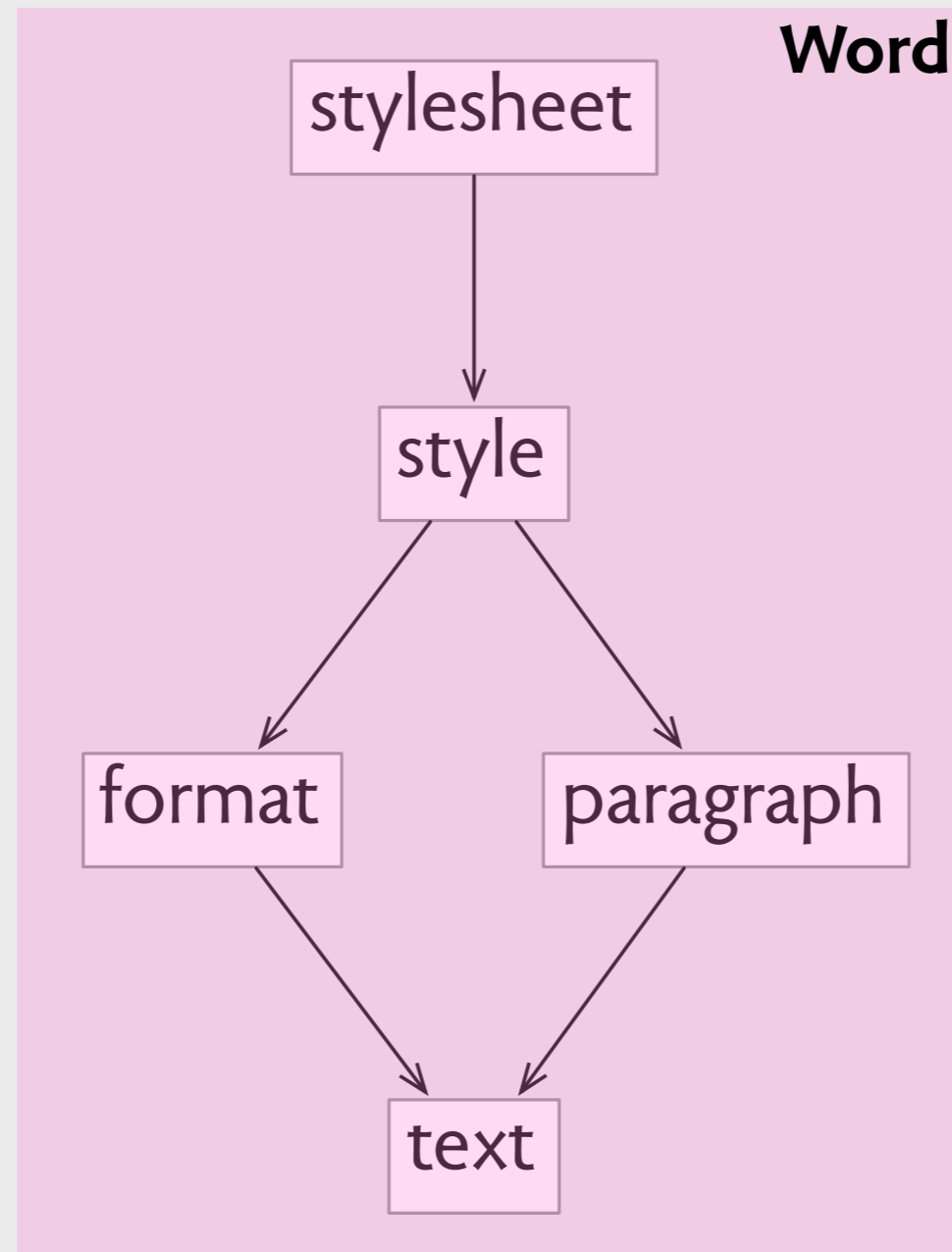

how
to reuse
a concept

other instantiations style

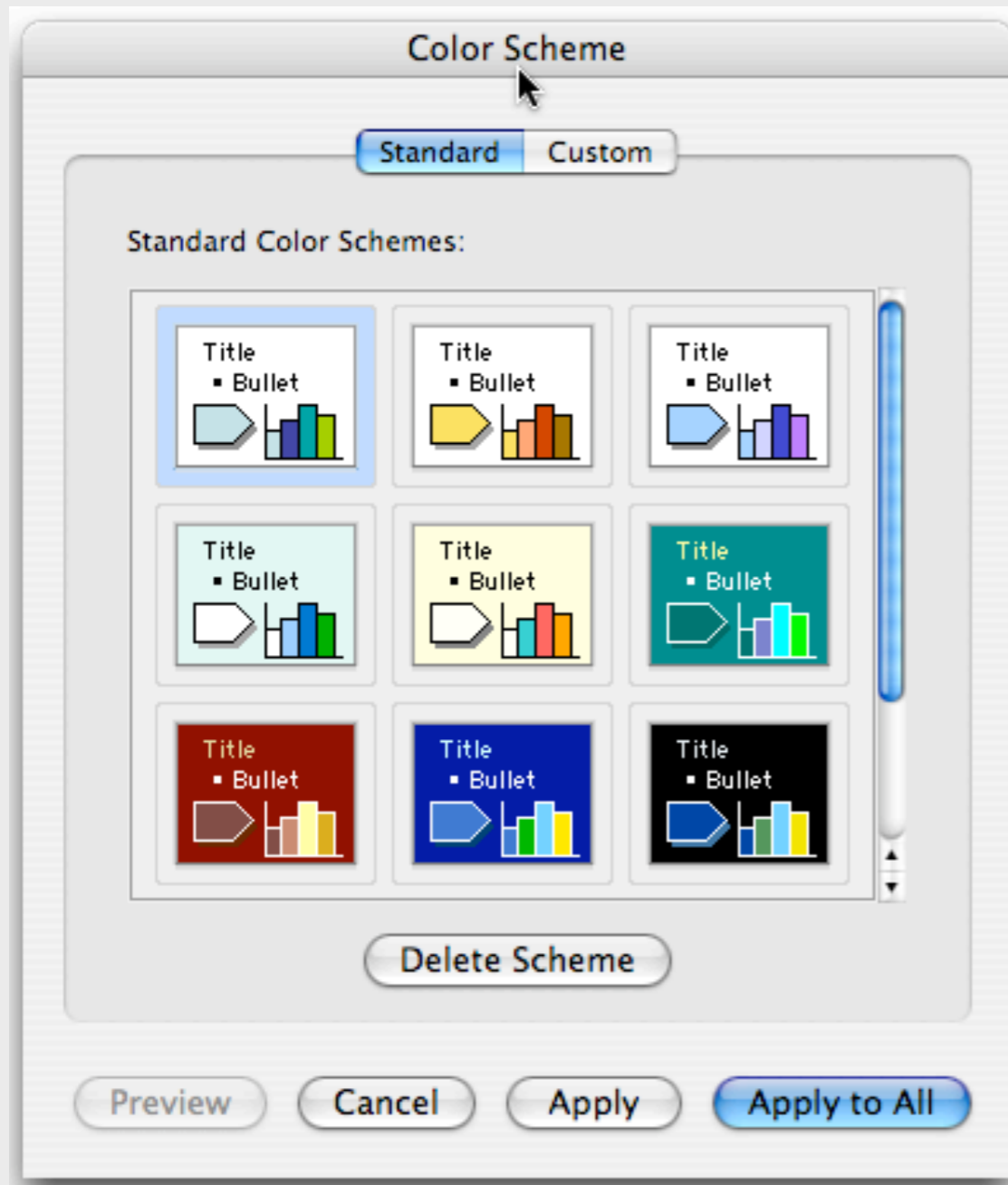

Powerpoint schemes

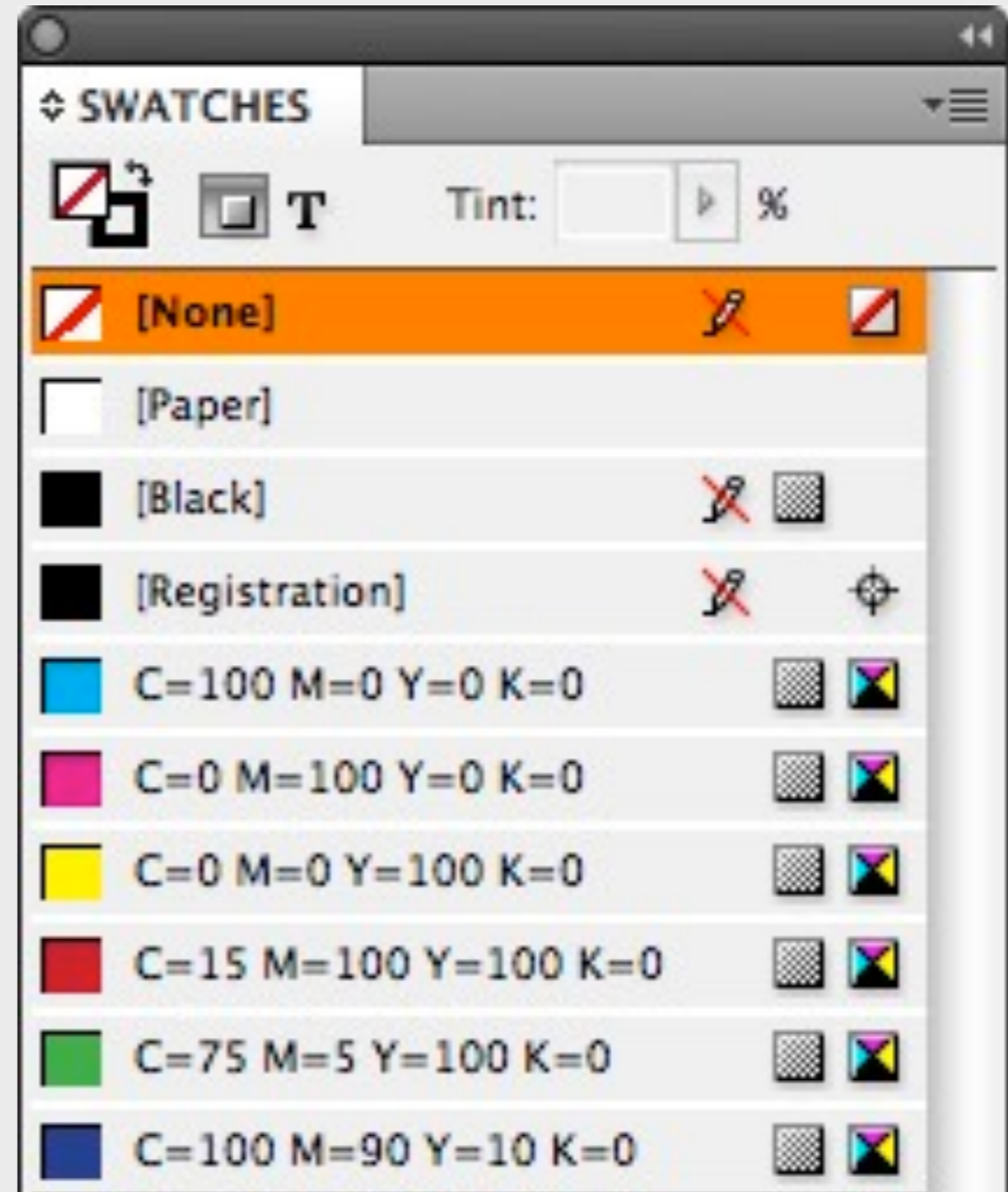

Indesign swatches

non-instantiations style

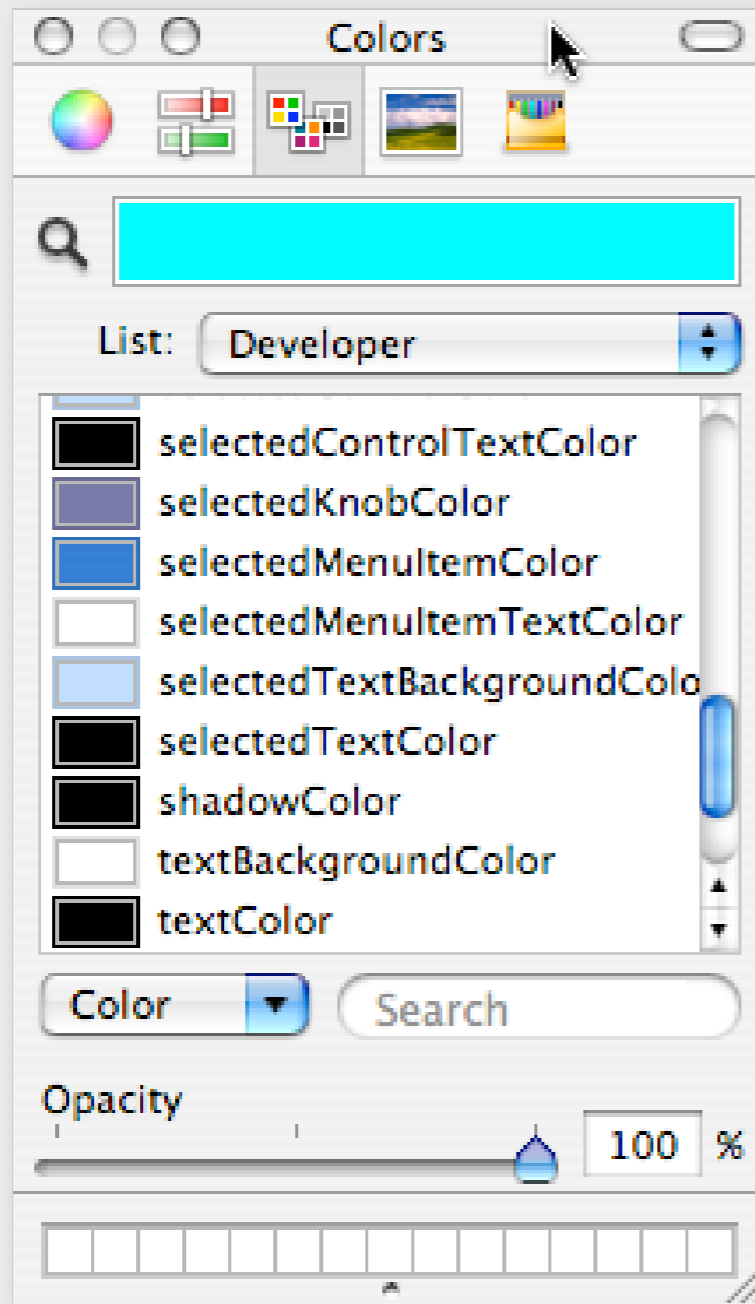

Apple color picker

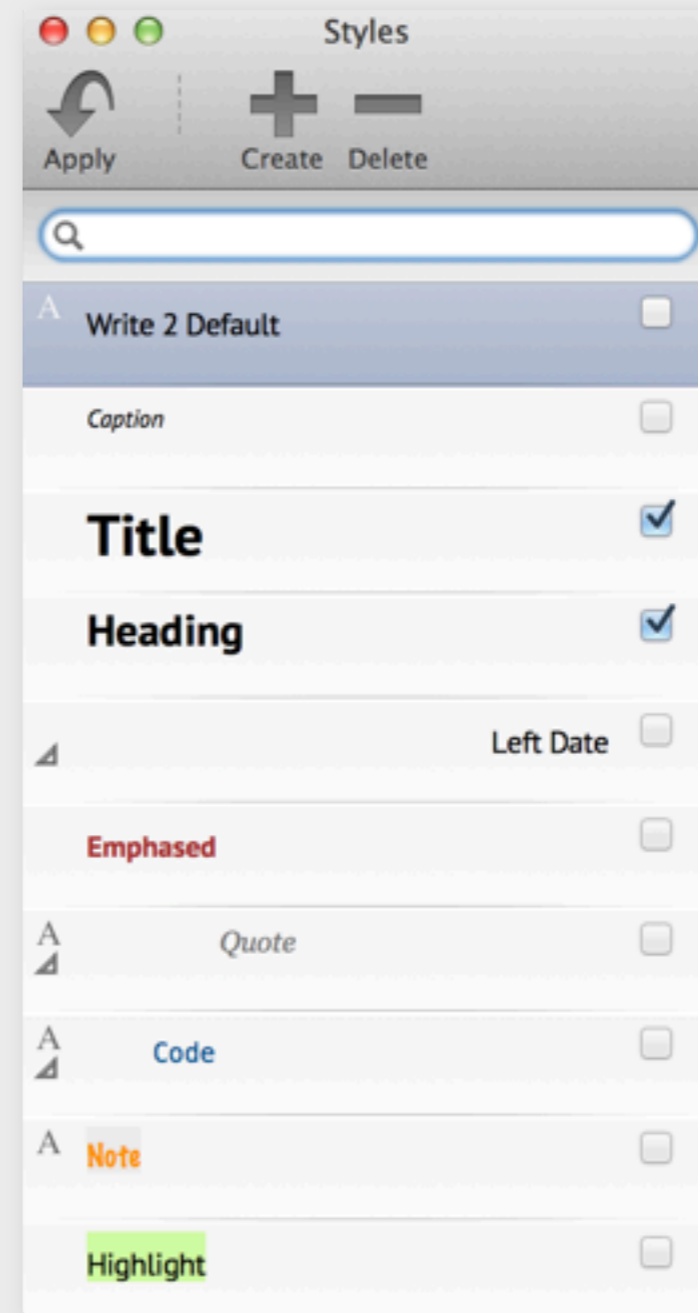

Write 2 text editor

non-instantiations style

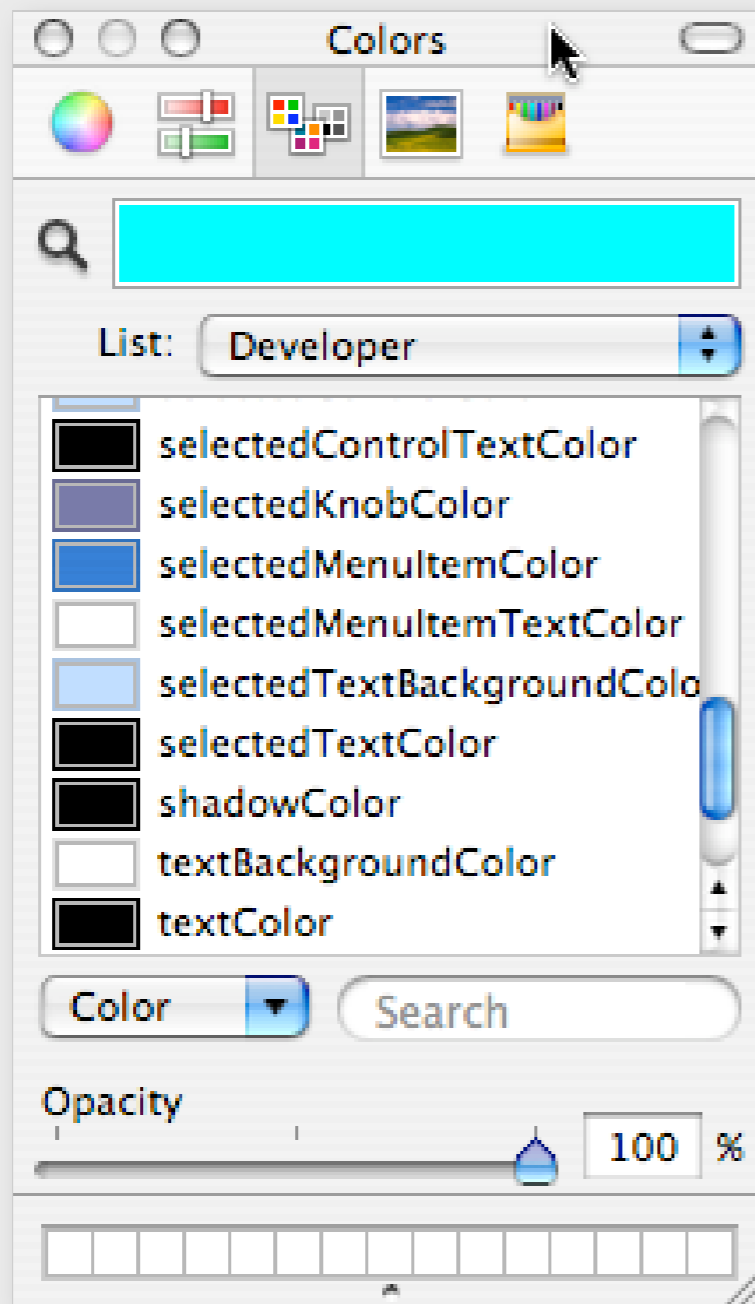

Apple color picker
swatch-color mapping fixed

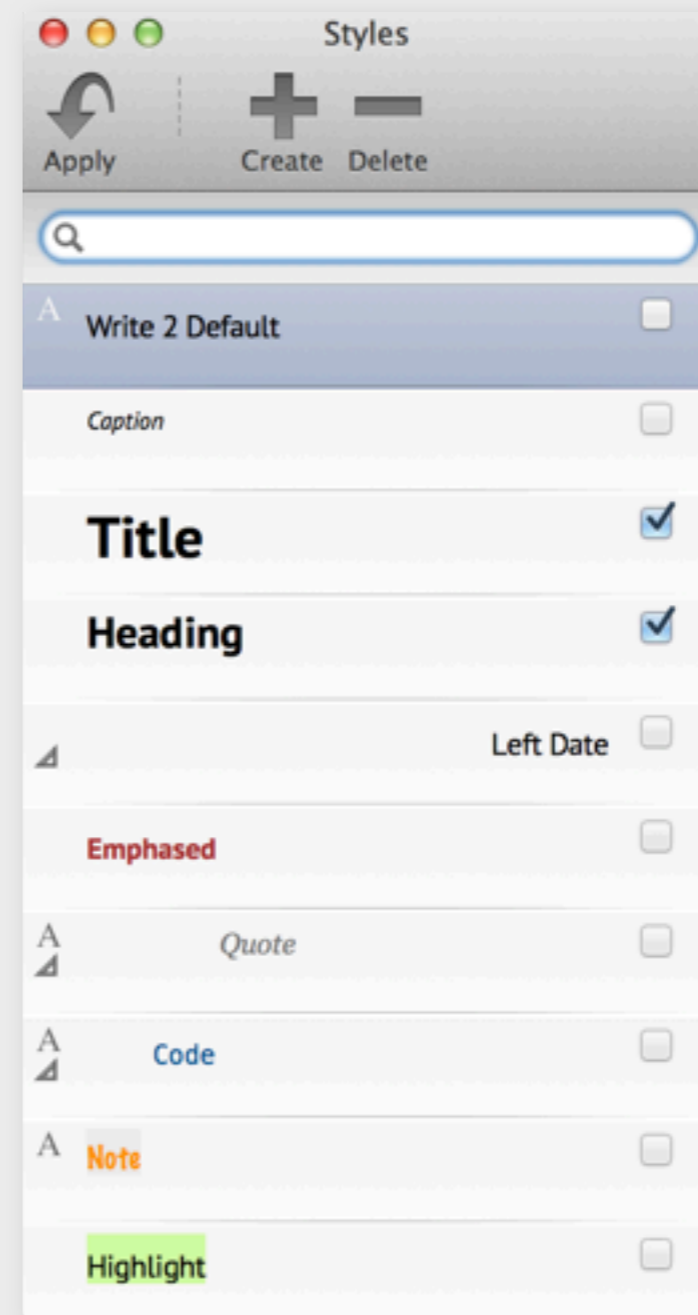

Write 2 text editor

non-instantiations style

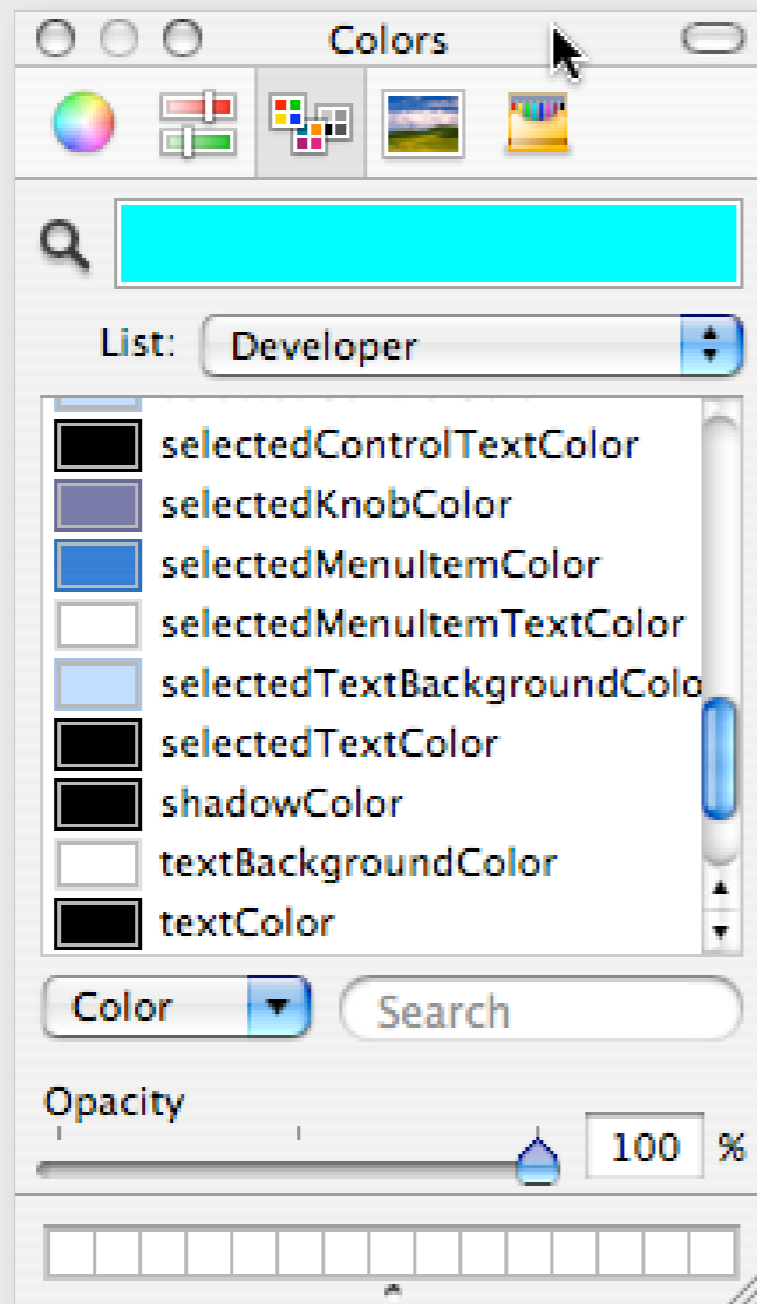

Apple color picker
swatch-color mapping fixed

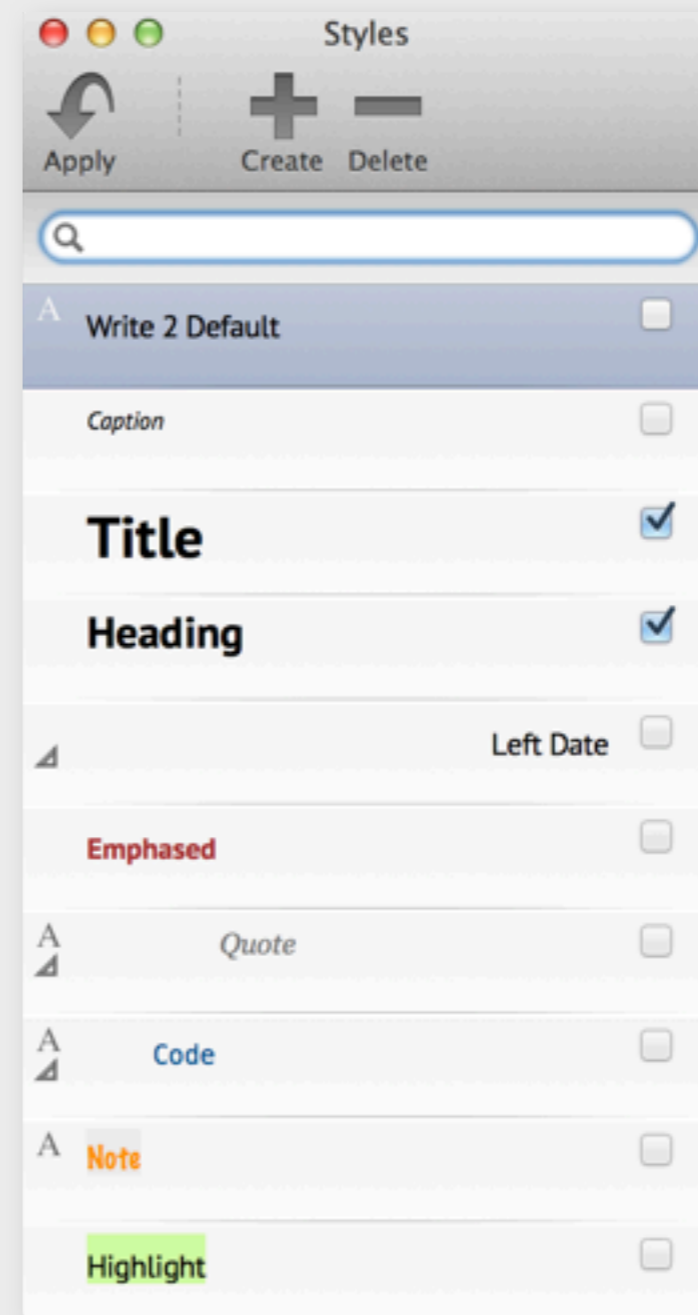

Write 2 text editor
no element-style mapping

style generic concept

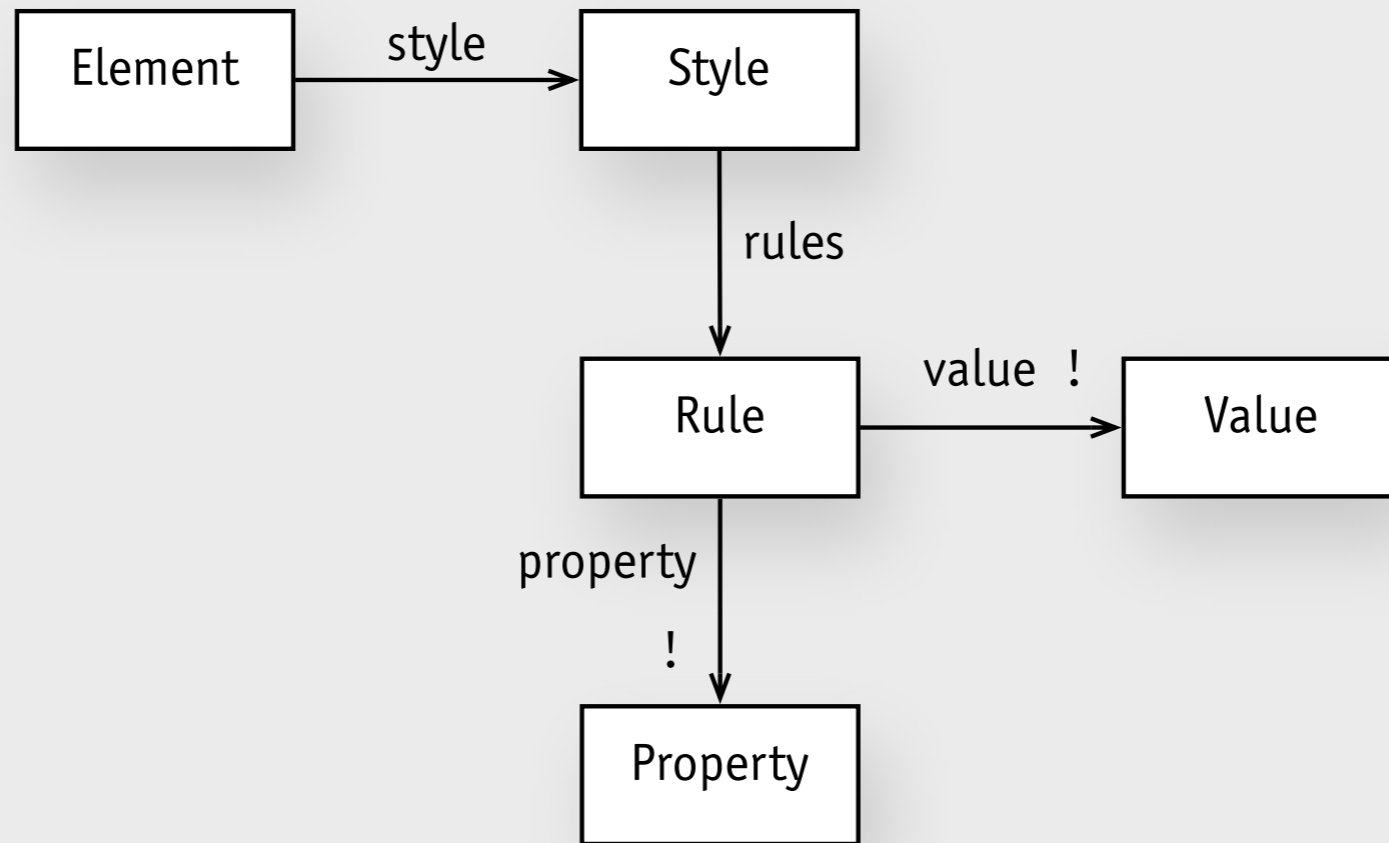

style generic concept

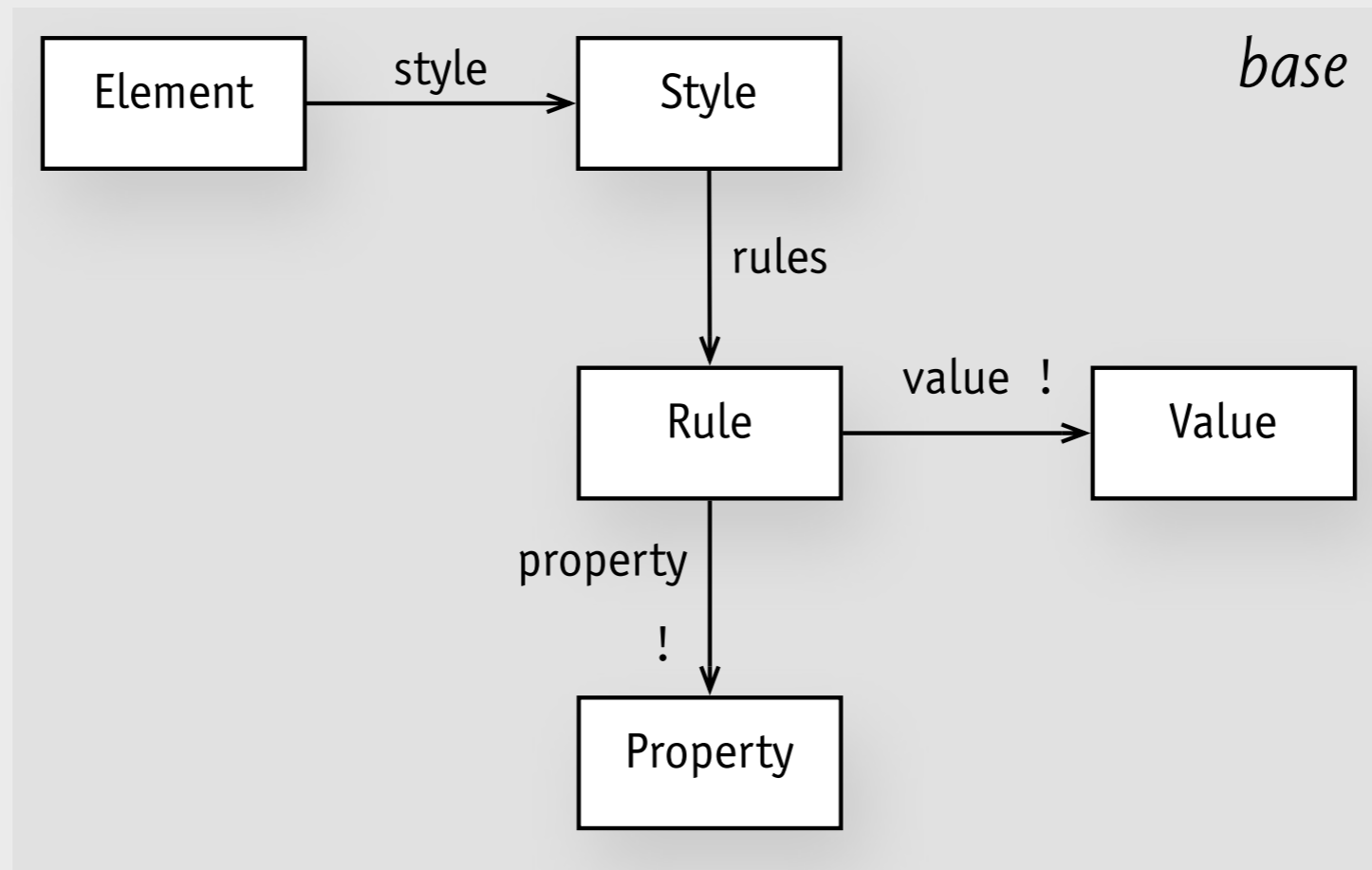

style generic concept

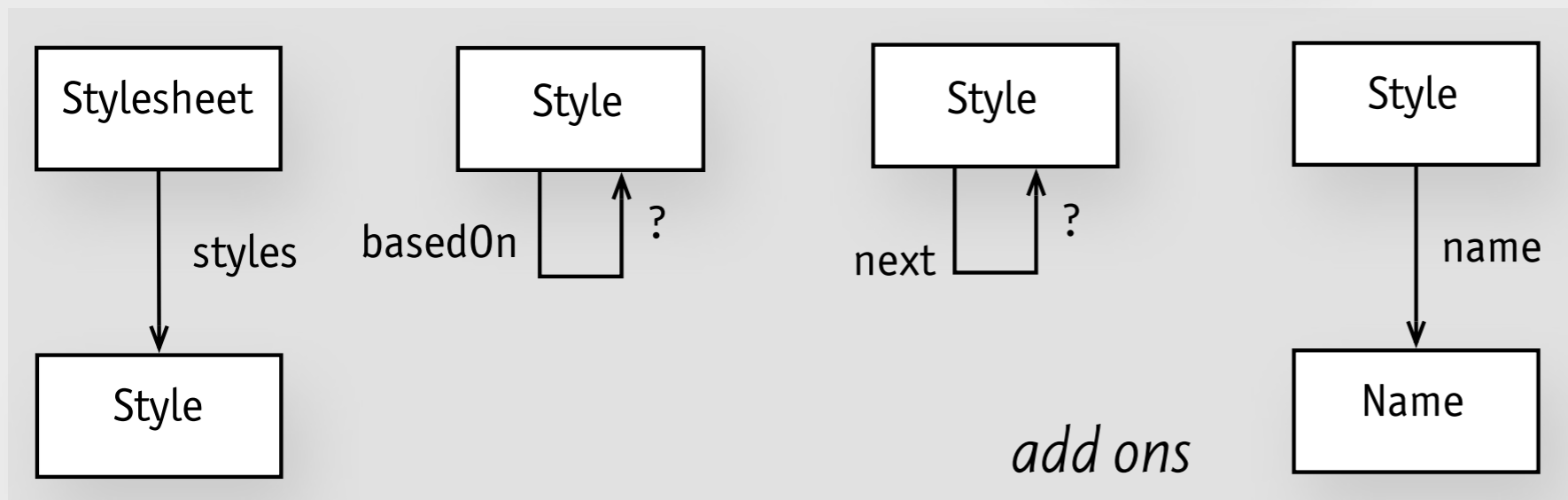
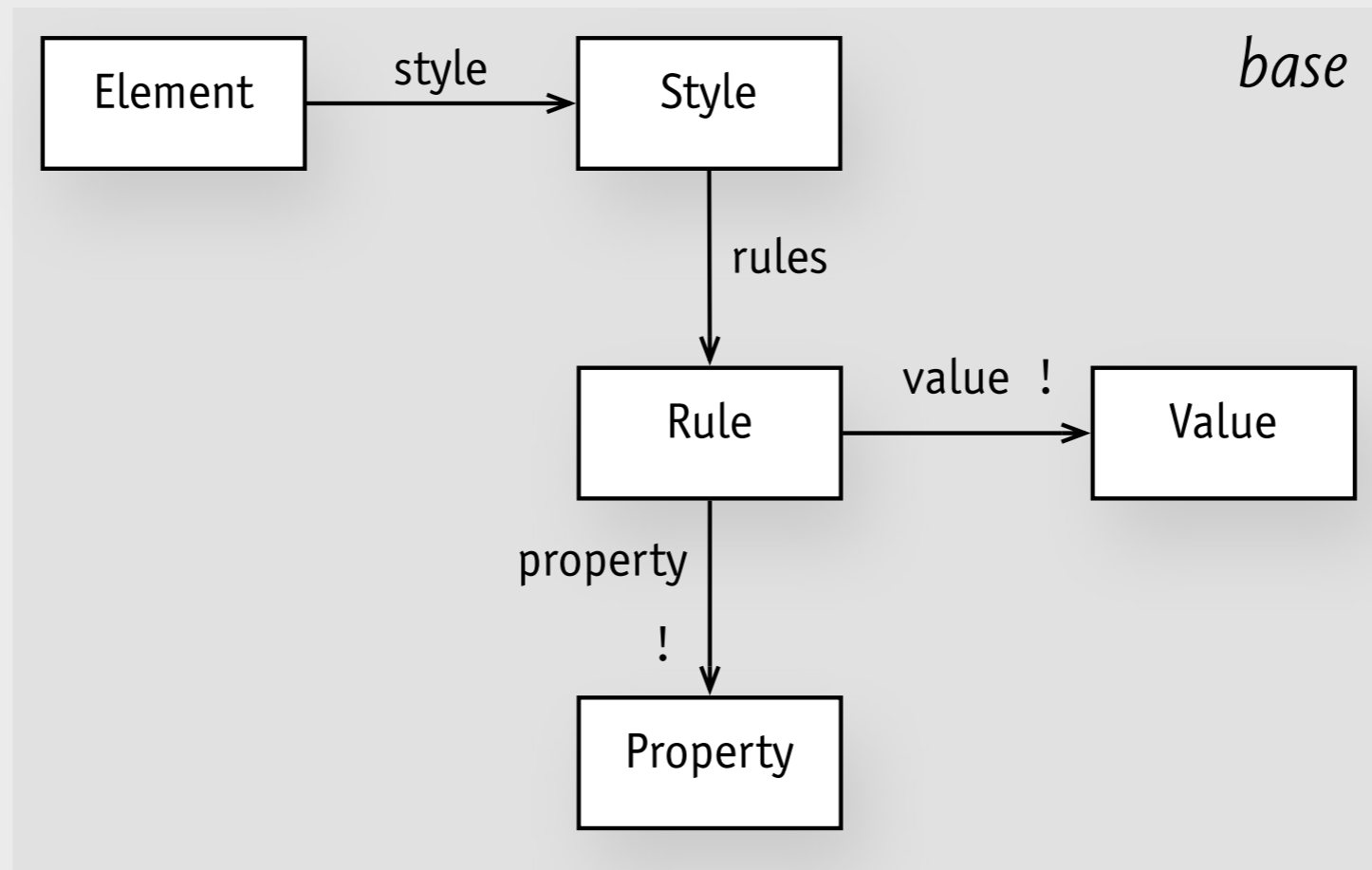

style generic concept

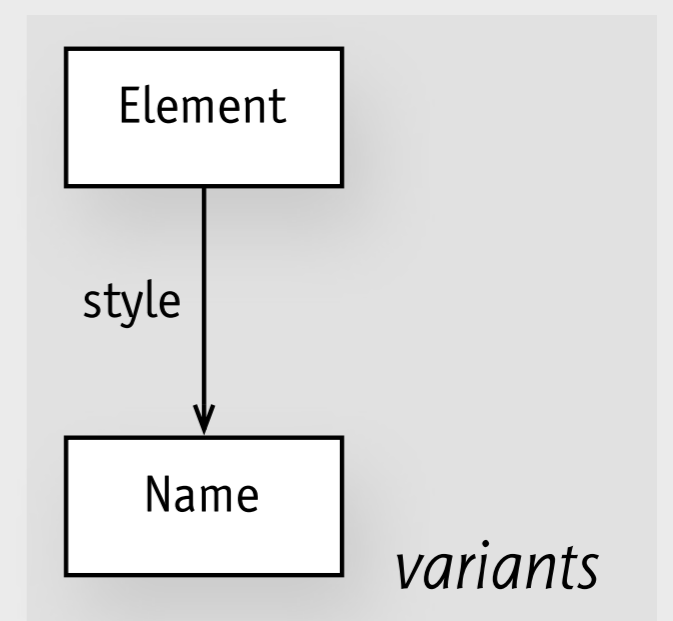
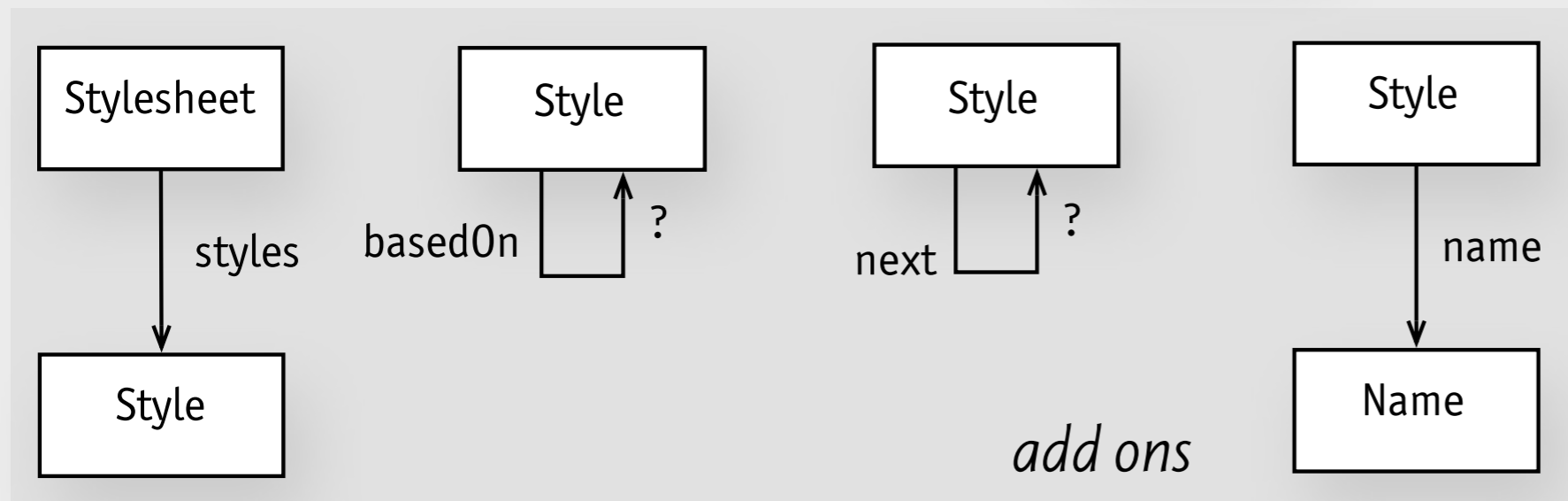
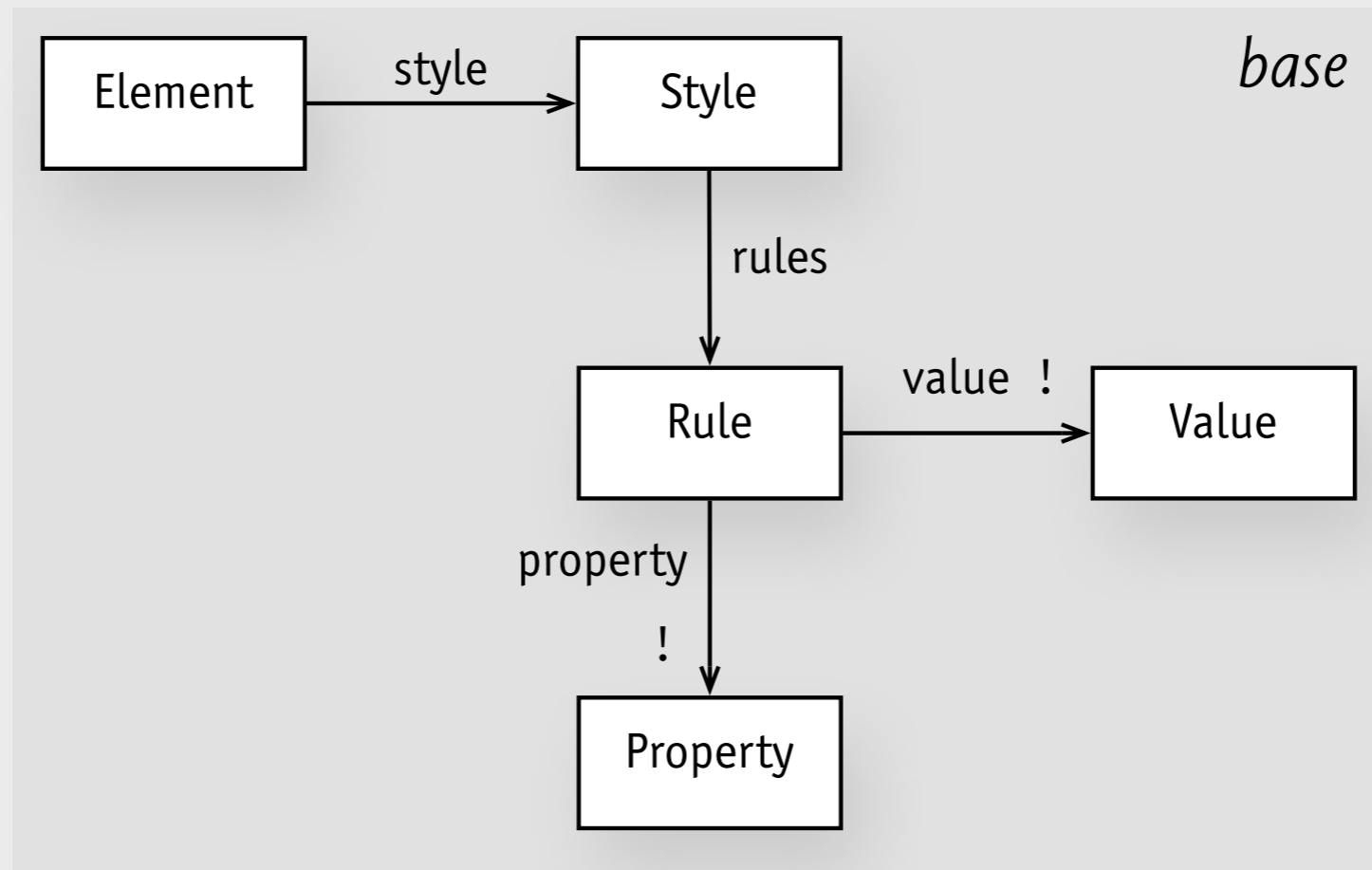

generic concept parts

part	example
name	Style
purpose	make it easy to maintain consistent format across set of elements
sample uses	Text formatting in word processors/layout apps (Word, Indesign, Pages, etc); rules in CSS; color themes in Powerpoint.
model	<i>base, add-ons, variants</i>
operations	add, delete, modify, apply, update
related to	StyleBuffer, Stencil, Master
issues	optional rules problem

concept selection

concept selection



slides in
Keynote

concept selection



slides in
Keynote



photos in Adobe Lightroom

concept selection



slides in
Keynote



photos in Adobe Lightroom

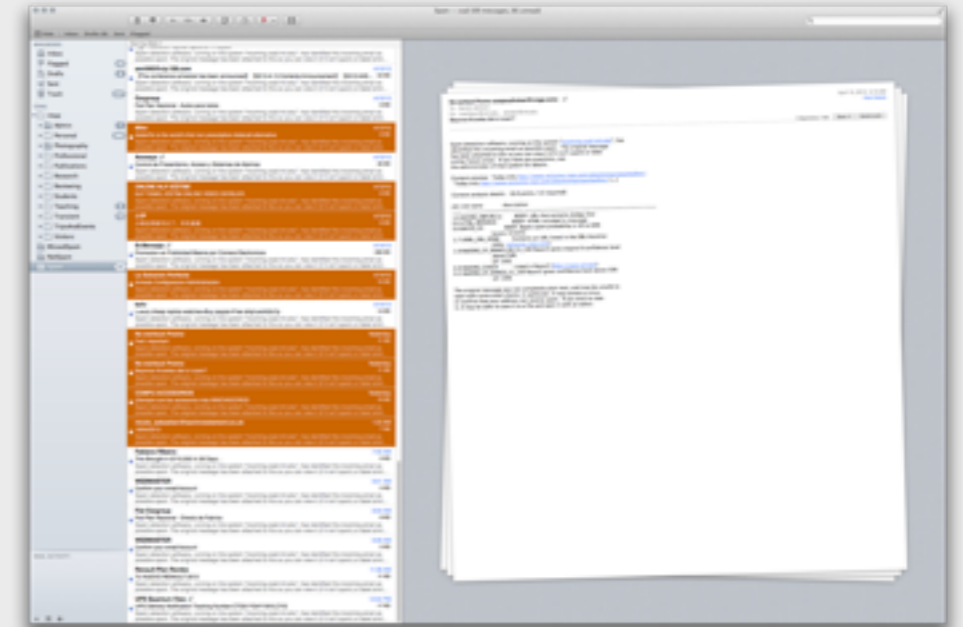

messages in Apple Mail

concept selection



slides in
Keynote



photos in Adobe Lightroom

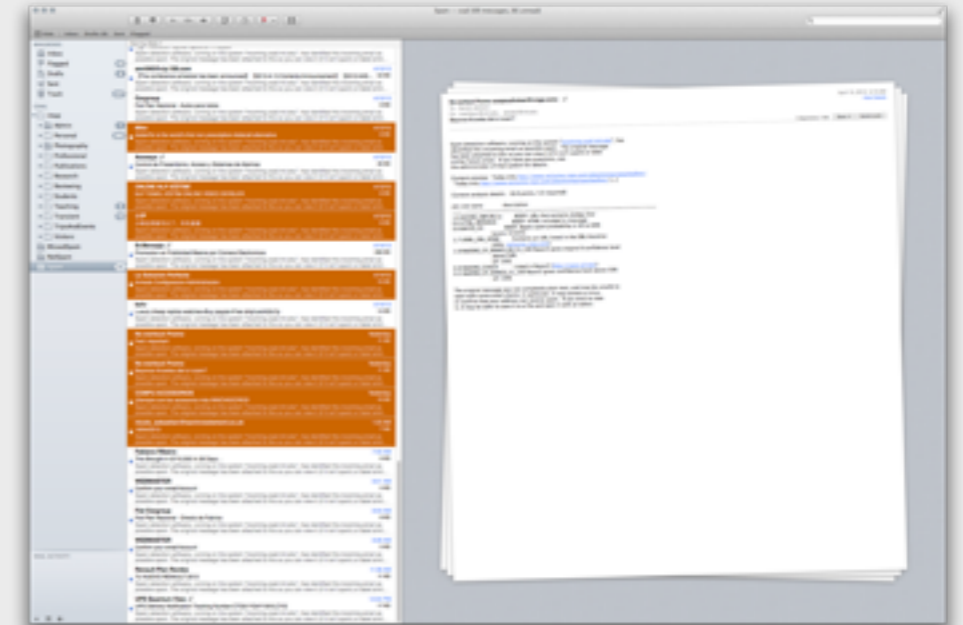

messages in Apple Mail



notes in Evernote

concept selection



slides in Keynote



photos in Adobe Lightroom

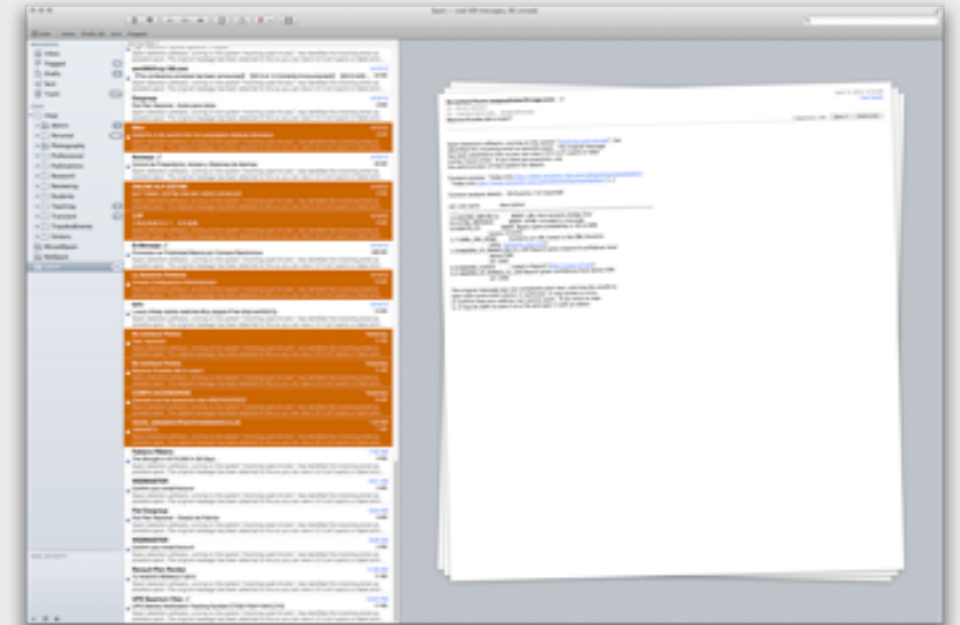

messages in Apple Mail

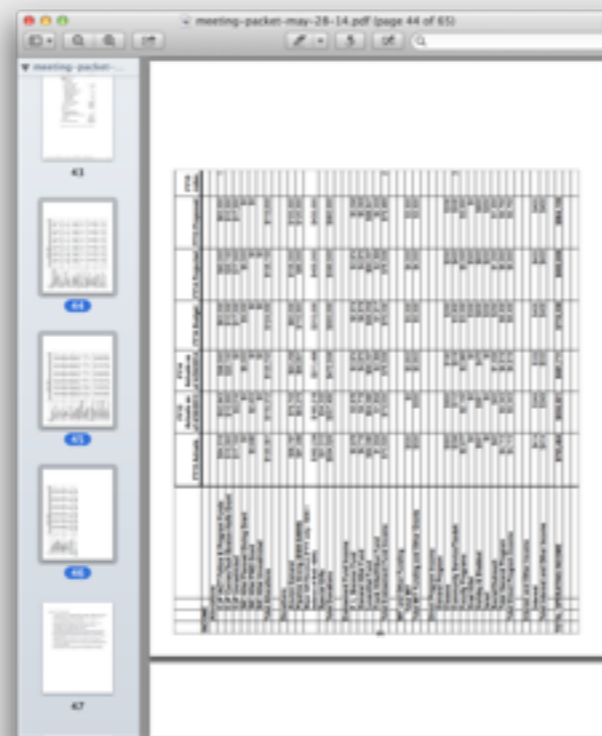

thumbnails in Preview

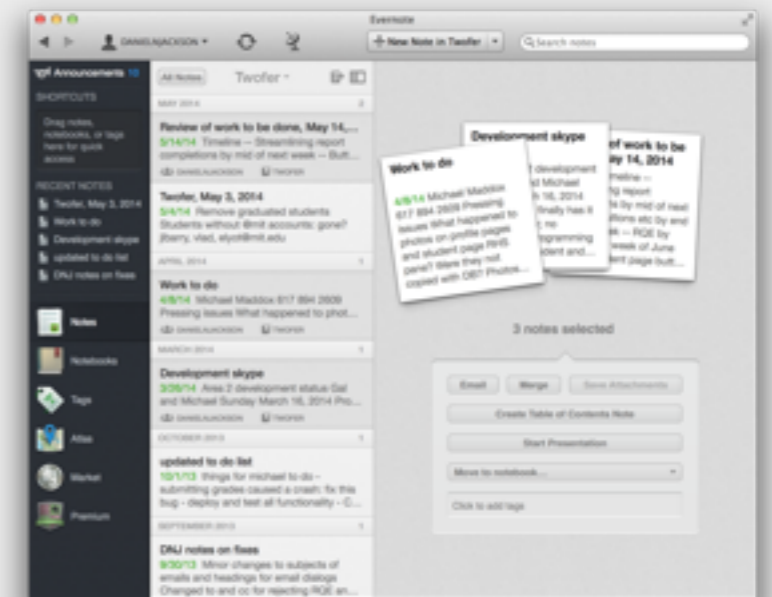

notes in Evernote

concept selection



slides in
Keynote



photos in Adobe Lightroom

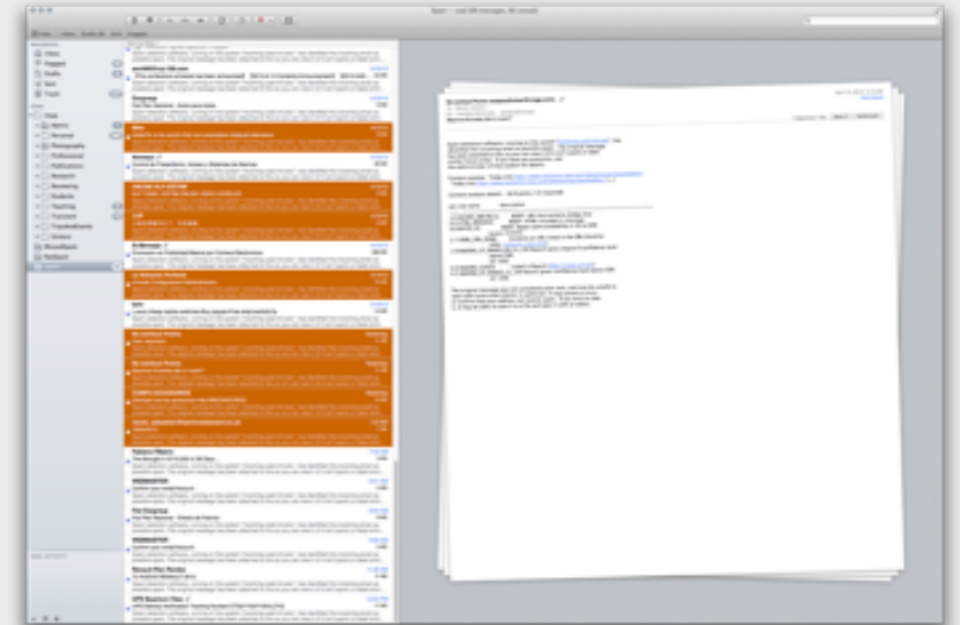

messages in Apple Mail

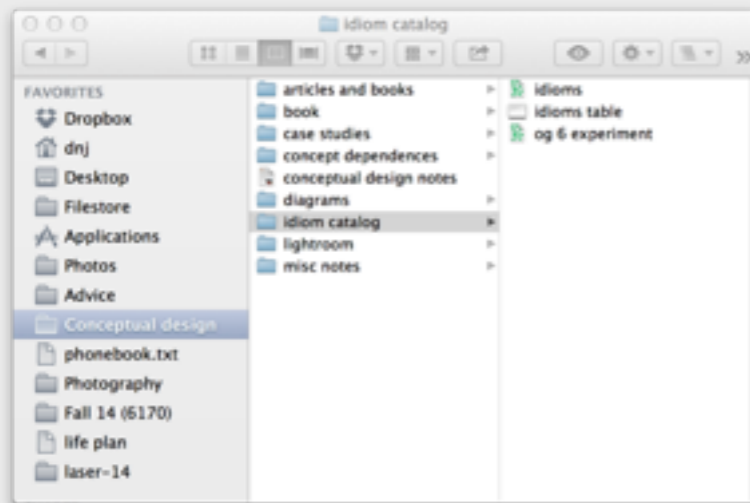

objects in OS X Finder

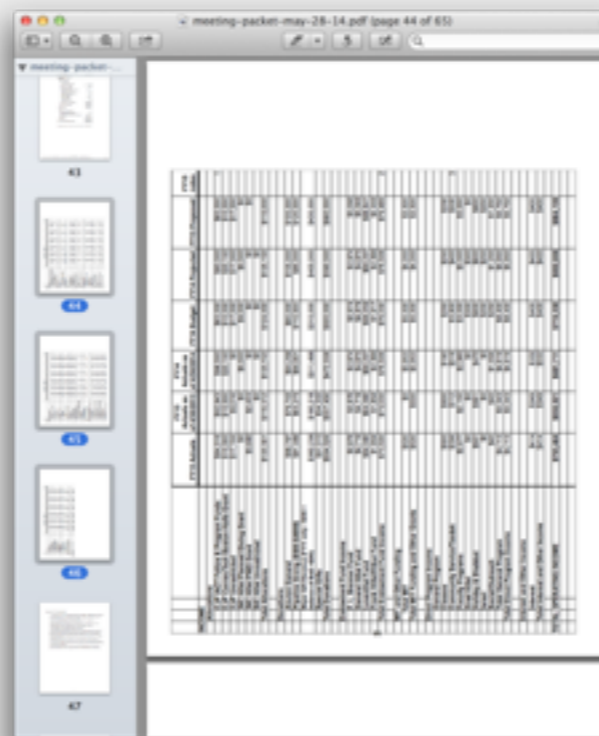

thumbnails in Preview



notes in Evernote

subtlety selection scope

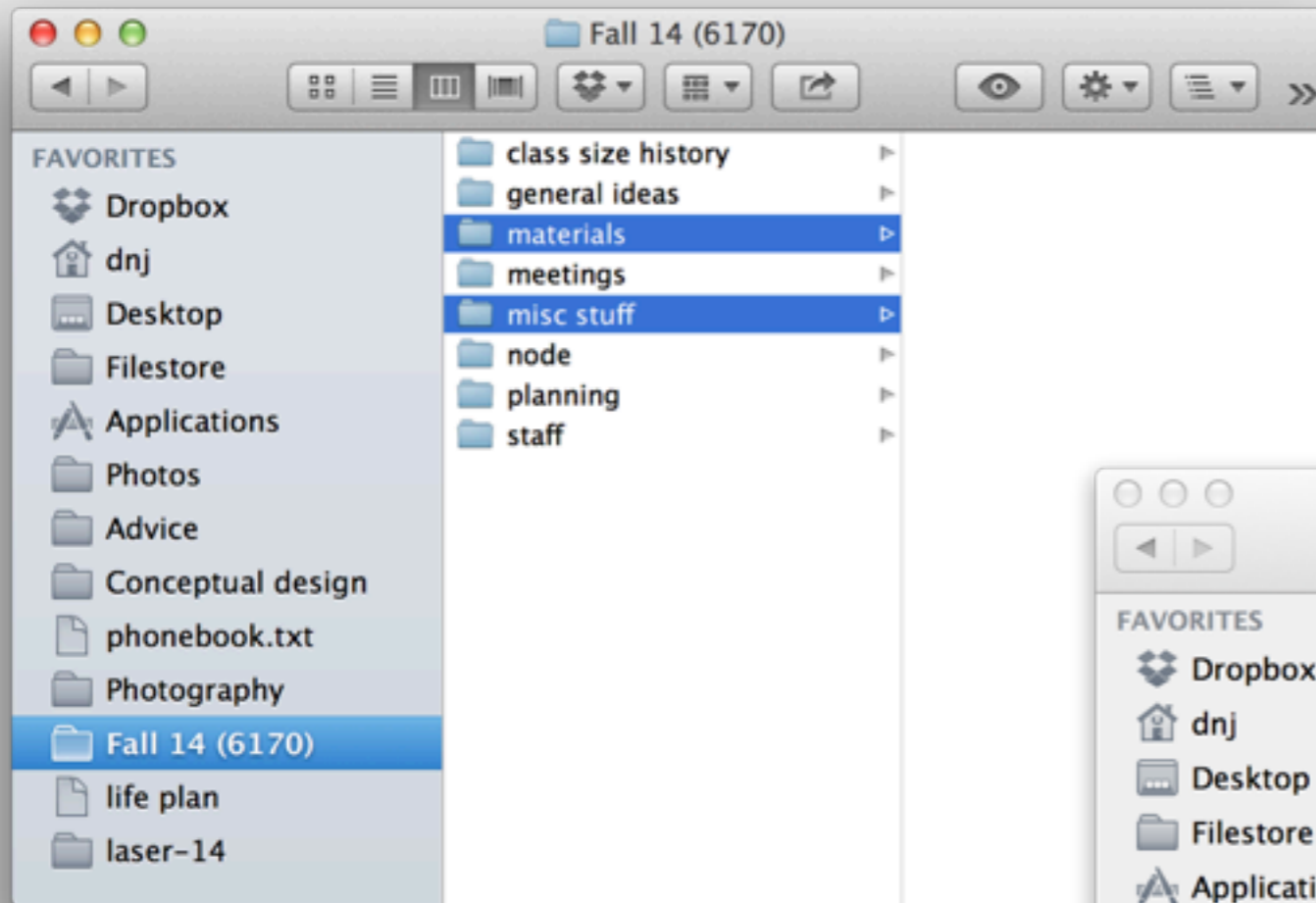

subset of selection in scope

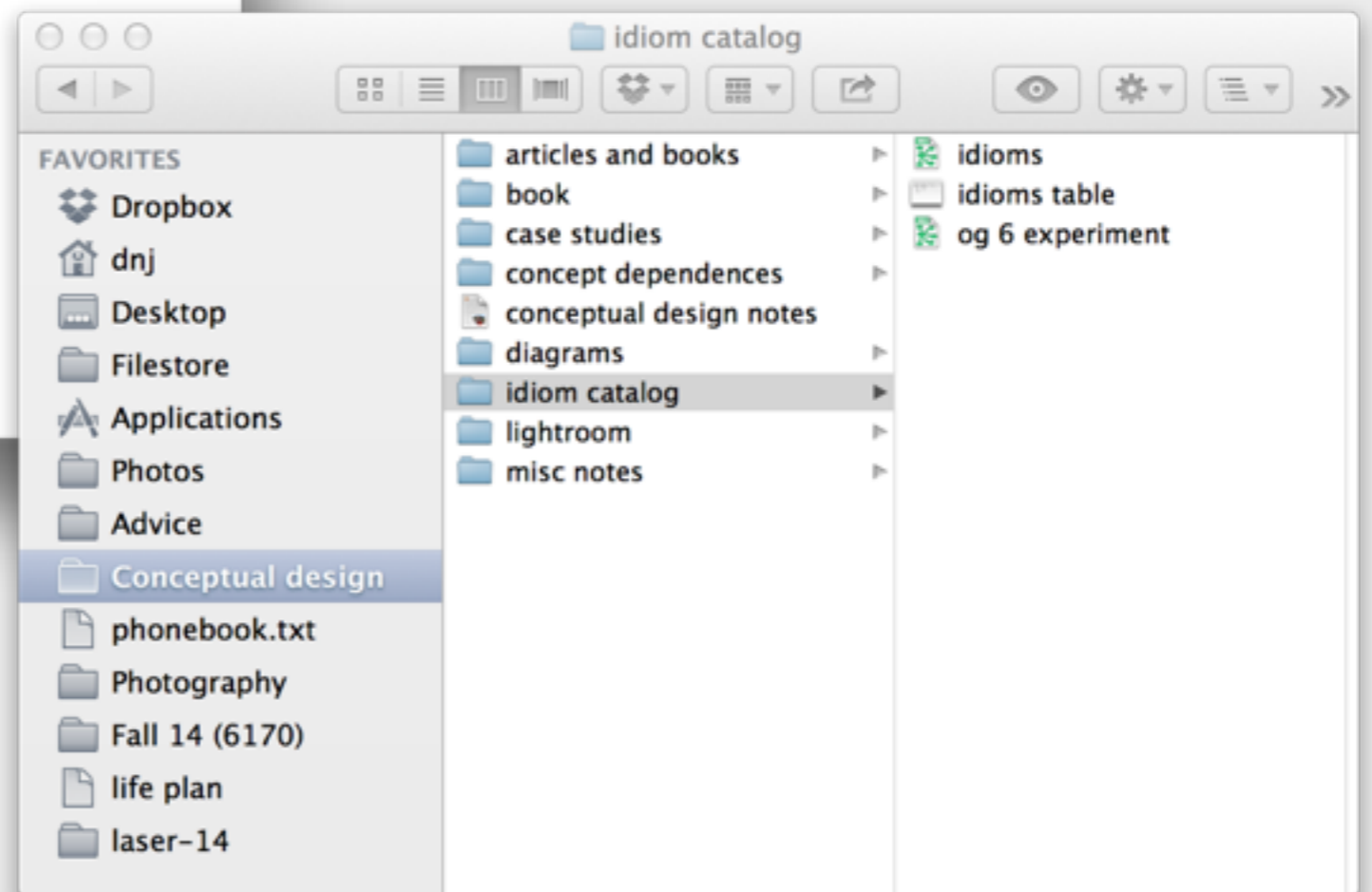

subset of selection out of scope

subtlety active element



Adobe Lightroom: brightest thumbnail is the “active photo”

subtlety continuous selection



Photoshop: outline shown with
“marching ants”

subtlety continuous selection



Photoshop: outline shown with
"marching ants"



Photoshop: selection shown in
Quick Mask mode

subtlety folder selection

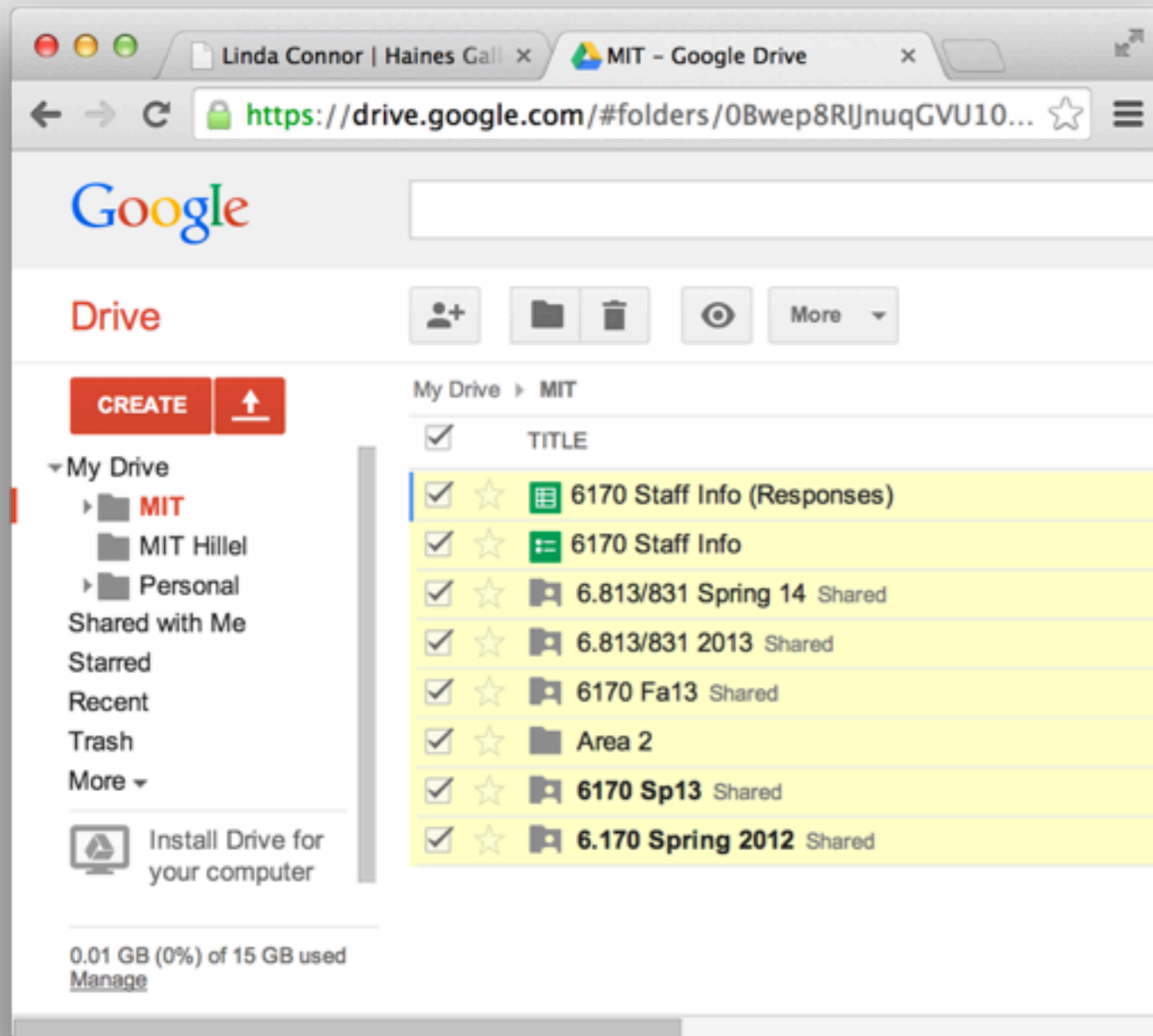

Google Drive: selecting folder =
selecting children

subtlety folder selection

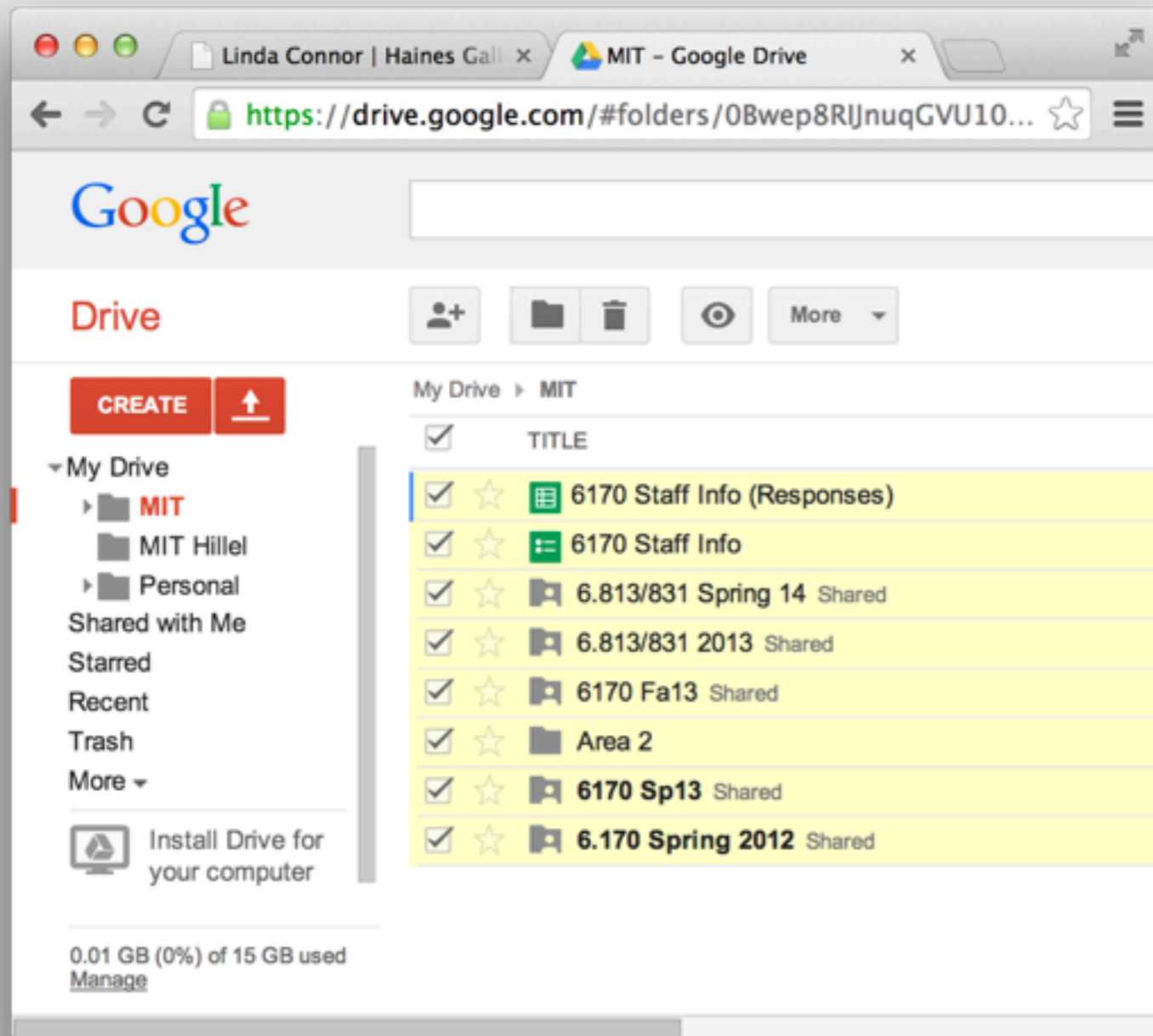

Google Drive: selecting folder = selecting children

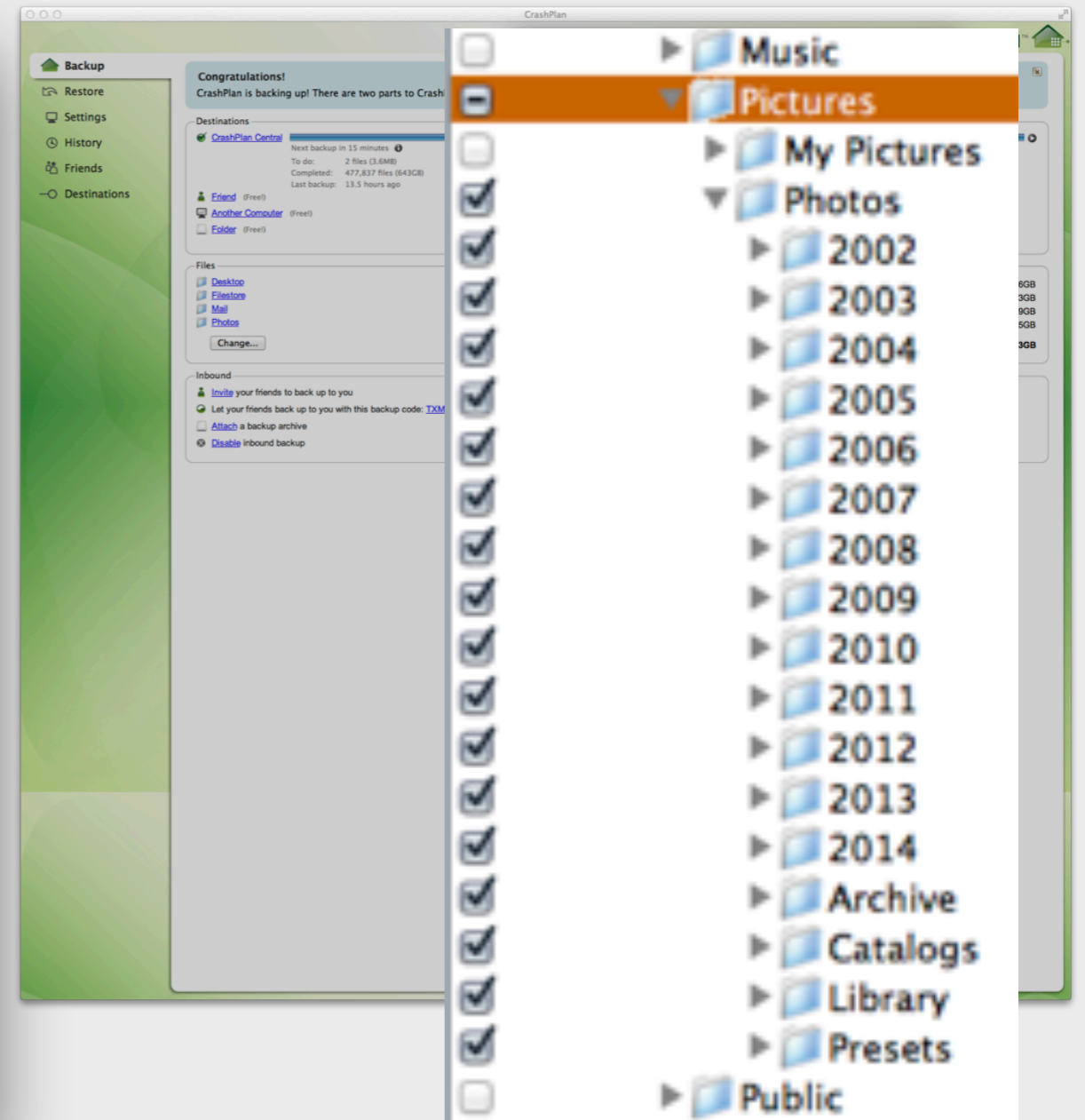

CrashPlan: selecting folder = selecting all future children

concept selection

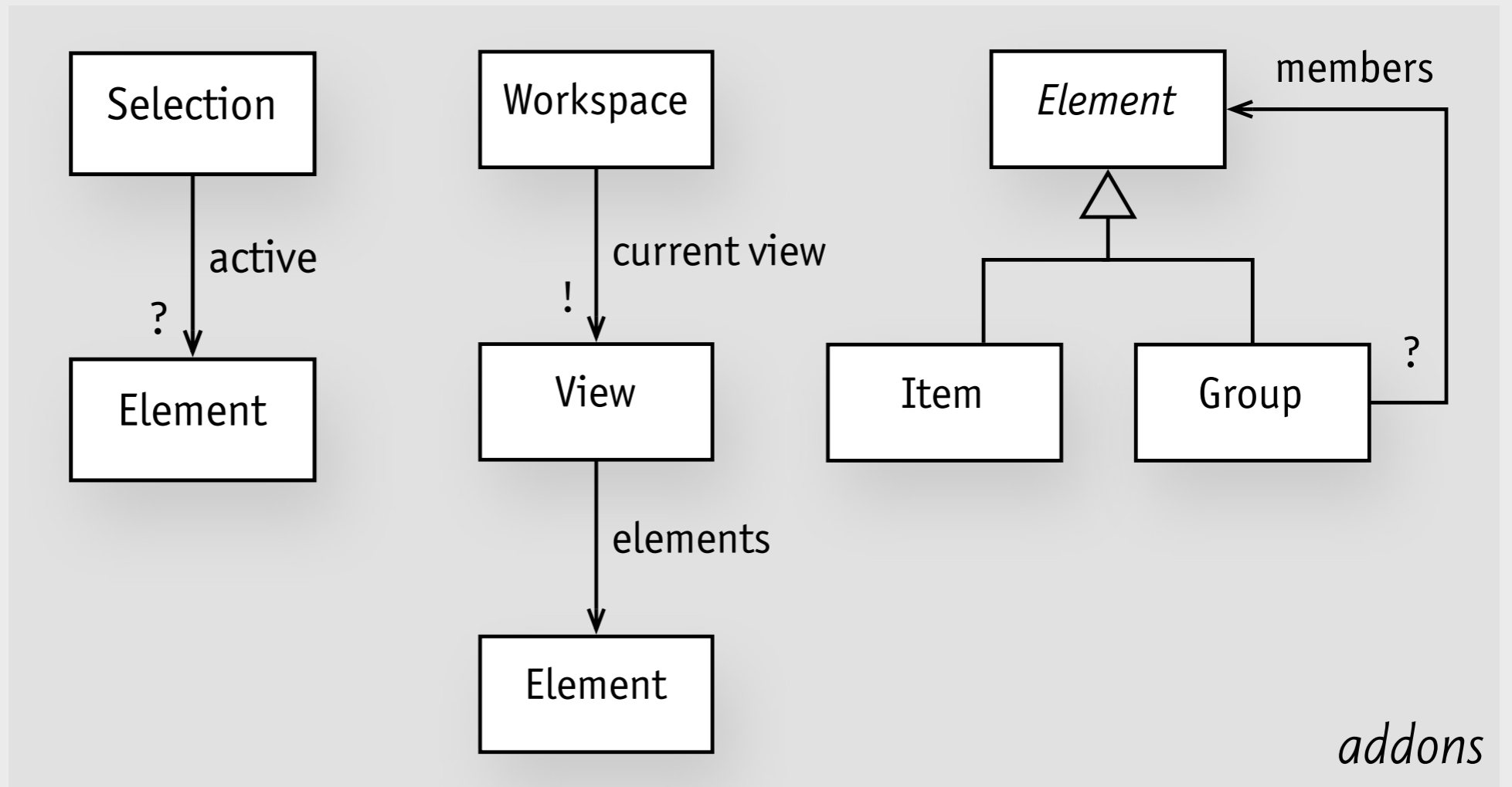
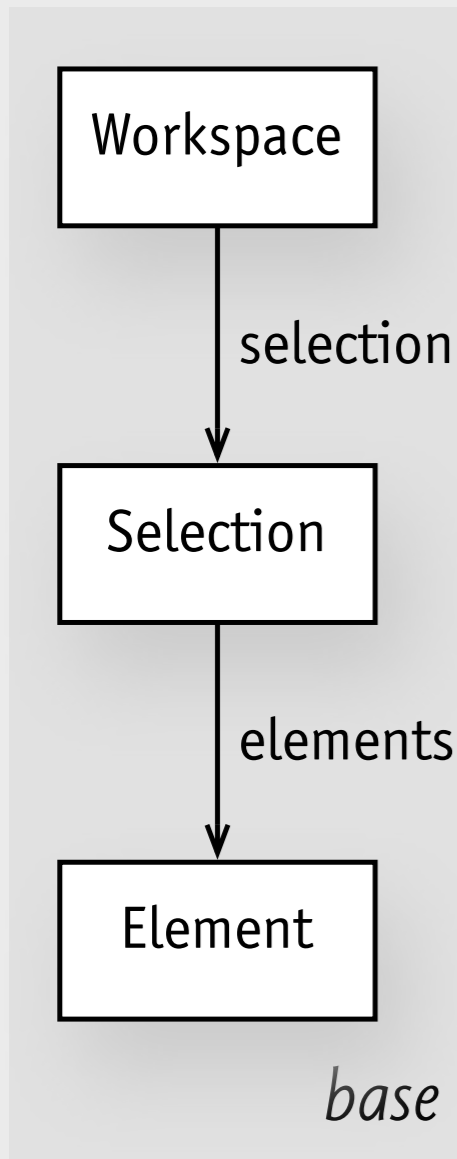

Purposes: apply action in aggregate to many items at once

concept catalog (so far)

<i>instantiate</i>	<i>organize</i>	<i>relate</i>	<i>resource</i>	<i>save</i>	<i>communicate</i>	<i>personalize</i>
stylesheet	selection	friend	access token	history	message	account
master	folder	clique	notification	buffer	posting	karma
stencil	group	invitation	reservation	cursor		OOBA
style buffer	label		REST	sync		rating
	layer		cart	export		status
	stack		subscription			
	alias		purchase order			
	preset		RMA			
	cursor		coupon			
	filter		catalog			
	property					
	metadata					

how to
evaluate
a concept

the fundamental principle



the fundamental principle

in a well-designed system



the fundamental principle

in a well-designed system
each concept is motivated by one purpose



the ideal mapping

purposes

concepts

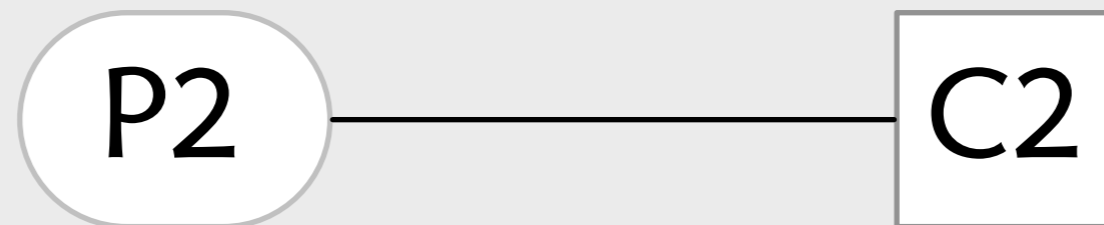

4 bad smells

unfulfilled purpose

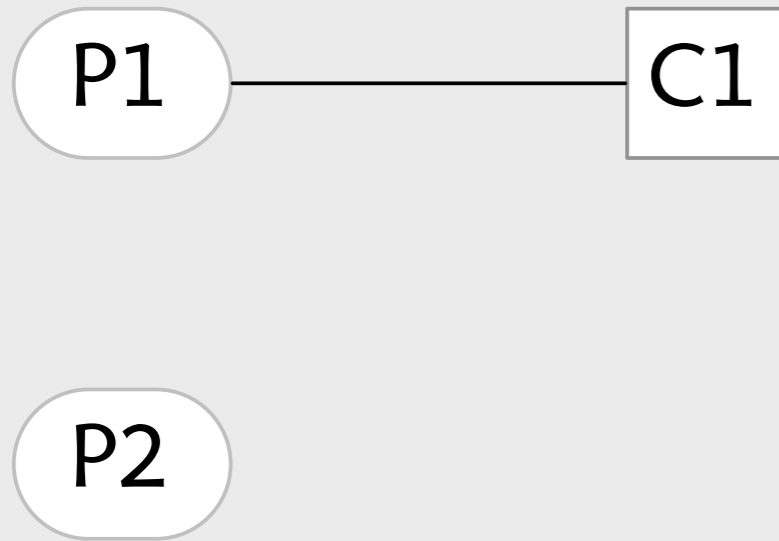

overloaded concept

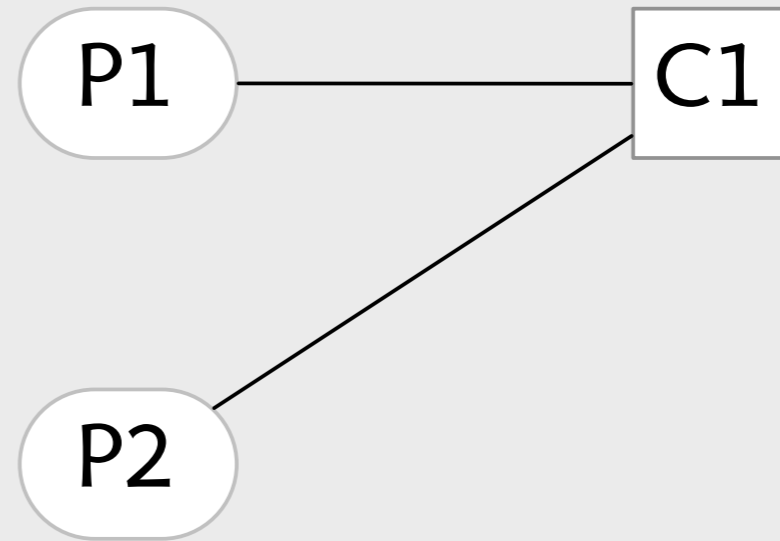

unmotivated concept

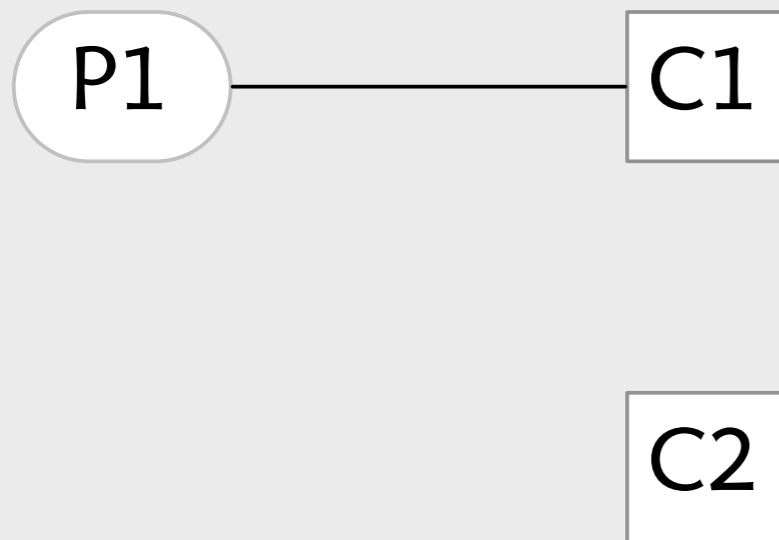

redundant concepts

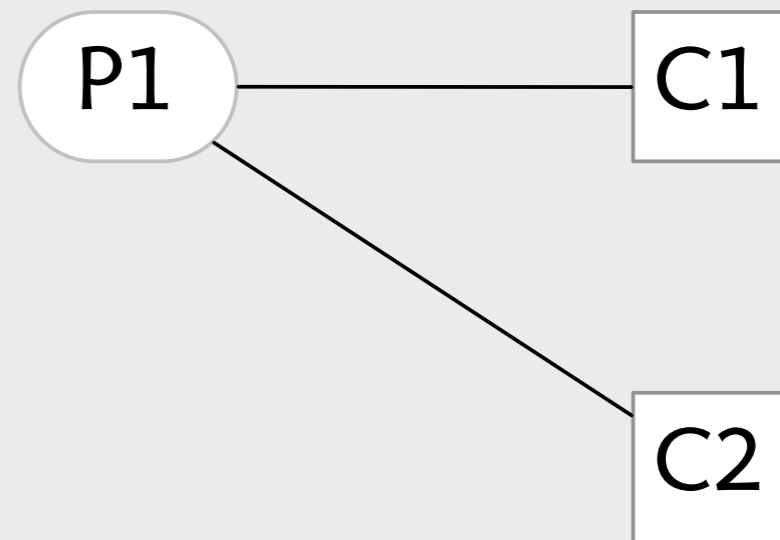

unfulfilled purposes

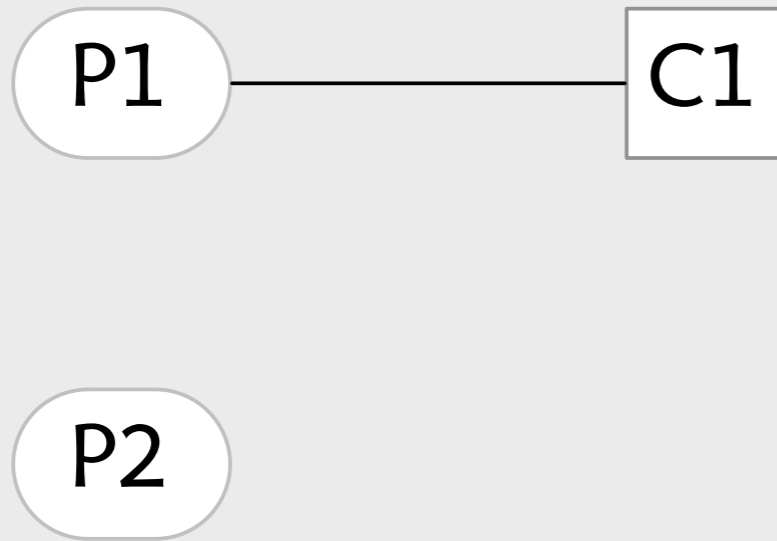

unfulfilled purposes

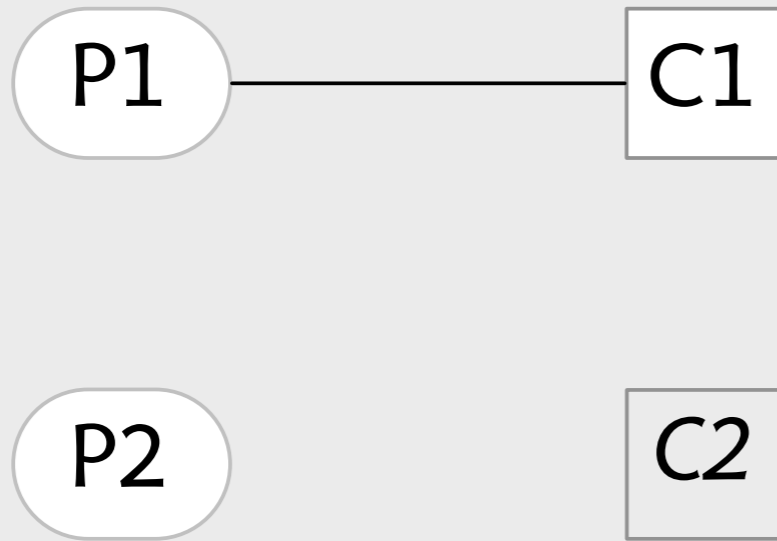

unfulfilled purposes

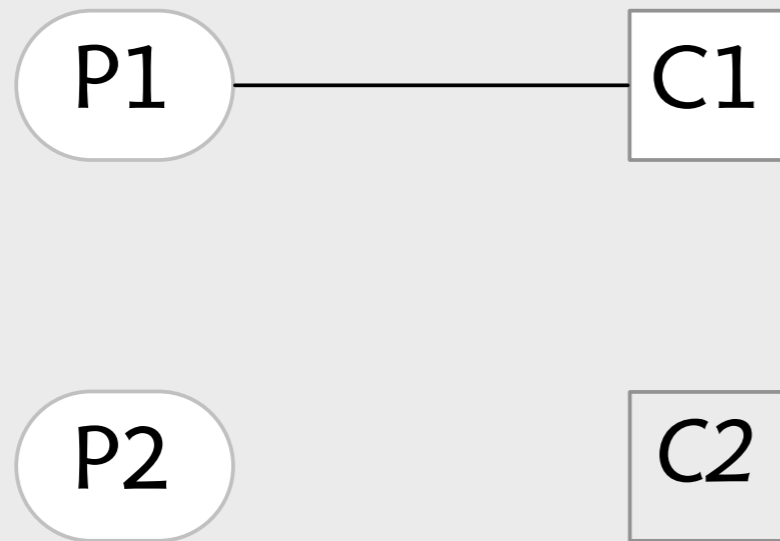

- Light
- LightFracs
- LightOS
- LightItalic
- LightItalicOS
- Normal
- NormalFracs
- NormalOS
- ✓ Italic
- ItalicFracs**
- ItalicOS
- Semibold
- SemiboldFracs
- SemiboldItalic
- SemiboldItalicFracs
- SemiboldItalicOS
- SemiboldOS
- Bold
- BoldFracs
- BoldOS
- BoldItalic
- BoldItalicFracs
- BoldItalicOS

Adobe Indesign:
an unfulfilled purpose

unfulfilled purposes

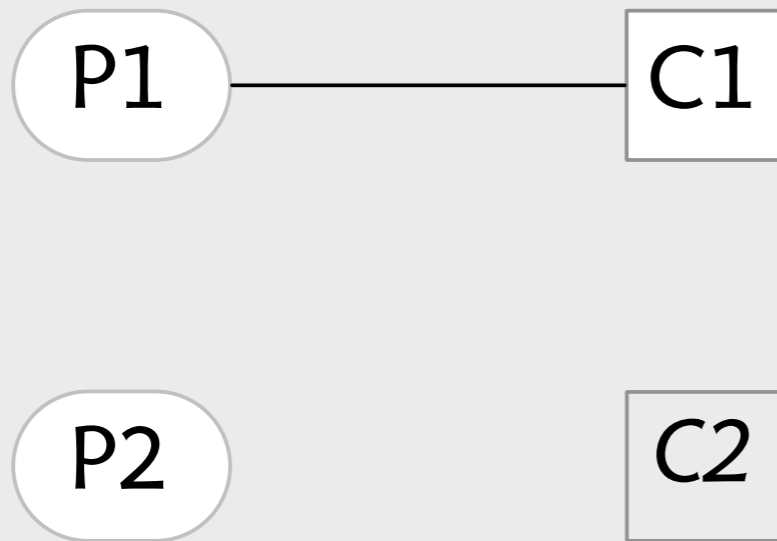

allow
typeface
independent
styling

- Light
- LightFracs
- LightOS
- LightItalic
- LightItalicOS
- Normal
- NormalFracs
- NormalOS
- ✓ Italic
- ItalicFracs**
- ItalicOS
- Semibold
- SemiboldFracs
- SemiboldItalic
- SemiboldItalicFracs
- SemiboldItalicOS
- SemiboldOS
- Bold
- BoldFracs
- BoldOS
- BoldItalic
- BoldItalicFracs
- BoldItalicOS

Adobe Indesign:
an unfulfilled purpose

unfulfilled purposes

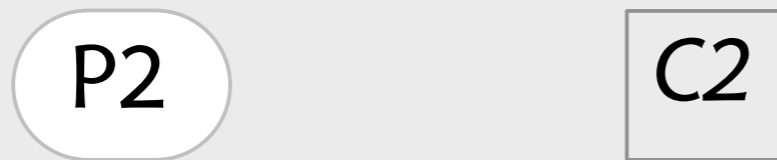
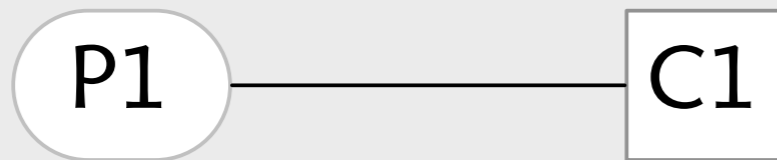

allow
typeface
independent
styling

subfamily

- Light
- LightFracs
- LightOS
- LightItalic
- LightItalicOS
- Normal
- NormalFracs
- NormalOS
- ✓ Italic
- ItalicFracs**
- ItalicOS
- Semibold
- SemiboldFracs
- SemiboldItalic
- SemiboldItalicFracs
- SemiboldItalicOS
- SemiboldOS
- Bold
- BoldFracs
- BoldOS
- BoldItalic
- BoldItalicFracs
- BoldItalicOS

Adobe Indesign:
an unfulfilled purpose

introducing a concept

introducing a concept

New character style:

Name:

▼ Include these character attributes:

<input checked="" type="checkbox"/> Font: Magma Light	<input checked="" type="checkbox"/> Capitalization: Standard
<input checked="" type="checkbox"/> Size: 12.0 pt	<input checked="" type="checkbox"/> Superscript:
<input checked="" type="checkbox"/> Character Spacing: 0%	<input checked="" type="checkbox"/> Baseline Shift: 0.0 pt
<input checked="" type="checkbox"/> Bold: Off	<input checked="" type="checkbox"/> Underline: None
<input checked="" type="checkbox"/> Italic: Off	<input checked="" type="checkbox"/> Color: <input type="color" value="black"/>
<input checked="" type="checkbox"/> Color: <input type="color" value="black"/>	<input checked="" type="checkbox"/> Strikethrough: None
<input checked="" type="checkbox"/> Shadow: Off	<input checked="" type="checkbox"/> Color: <input type="color" value="black"/>
<input checked="" type="checkbox"/> Fill: <input type="color" value="white"/>	
<input checked="" type="checkbox"/> Ligatures: Default	<input checked="" type="checkbox"/> Advanced Font Features
<input checked="" type="checkbox"/> Language: English	<small>See Typography in the Font Panel</small>

Apply this new style on creation

Keynote '09: has subfamilies

introducing a concept

New character style:

Name:

▼ Include these character attributes:

<input checked="" type="checkbox"/> Font: Magma Light	<input checked="" type="checkbox"/> Capitalization: Standard
<input checked="" type="checkbox"/> Size: 12.0 pt	<input checked="" type="checkbox"/> Superscript:
<input checked="" type="checkbox"/> Character Spacing: 0%	<input checked="" type="checkbox"/> Baseline Shift: 0.0 pt
<input checked="" type="checkbox"/> Bold: Off	<input checked="" type="checkbox"/> Underline: None
<input checked="" type="checkbox"/> Italic: Off	<input checked="" type="checkbox"/> Color: <input type="color" value="black"/>
<input checked="" type="checkbox"/> Color: <input type="color" value="black"/>	<input checked="" type="checkbox"/> Strikethrough: None
<input checked="" type="checkbox"/> Shadow: Off	<input checked="" type="checkbox"/> Color: <input type="color" value="black"/>
<input checked="" type="checkbox"/> Fill: <input type="color" value="white"/>	
<input checked="" type="checkbox"/> Ligatures: Default	<input checked="" type="checkbox"/> Advanced Font Features <small>See Typography in the Font Panel</small>
<input checked="" type="checkbox"/> Language: English	

Apply this new style on creation

Keynote '09: has subfamilies

Text

Body*

Font

Magma

Lightitalic 11 pt

B **/** U

Character Styles

Keynote 6: gone again!

unfulfilled purposes (more)

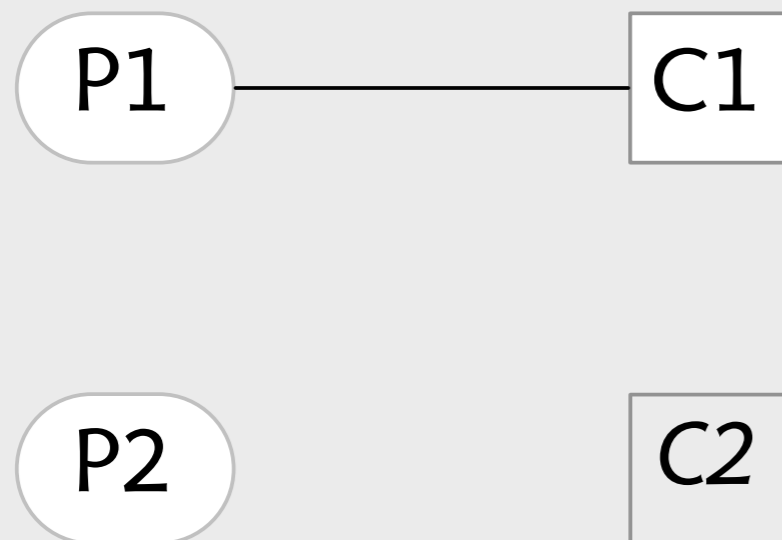

user (Apple Mail, Gmail)
'identify parties to communication'
weak search, no authentication

slide hierarchy (Powerpoint)
'structure slides in a tree'
sections provide just one level

eject-after-import (Lightroom)
'prevent accidental writing'
feature removed (and reinstated!)

binder (Preview, Acrobat)
'maintain composite PDF doc'
can insert pages, but forgets source

unmotivated concepts

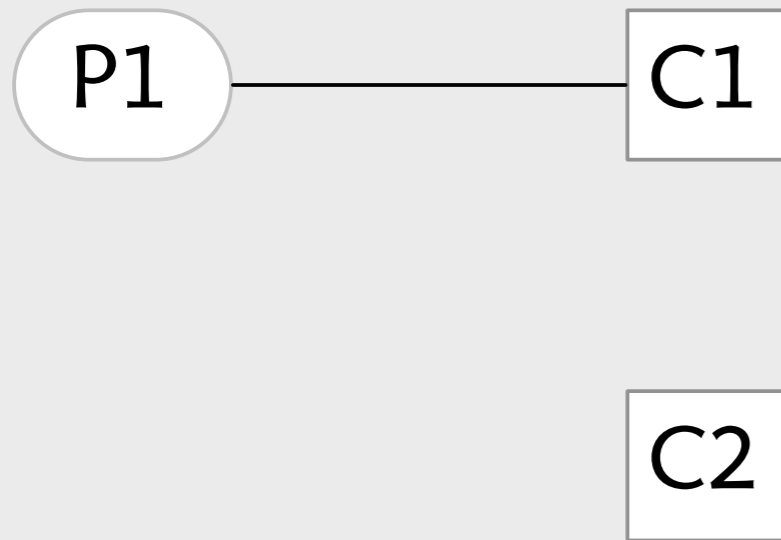

unmotivated concepts

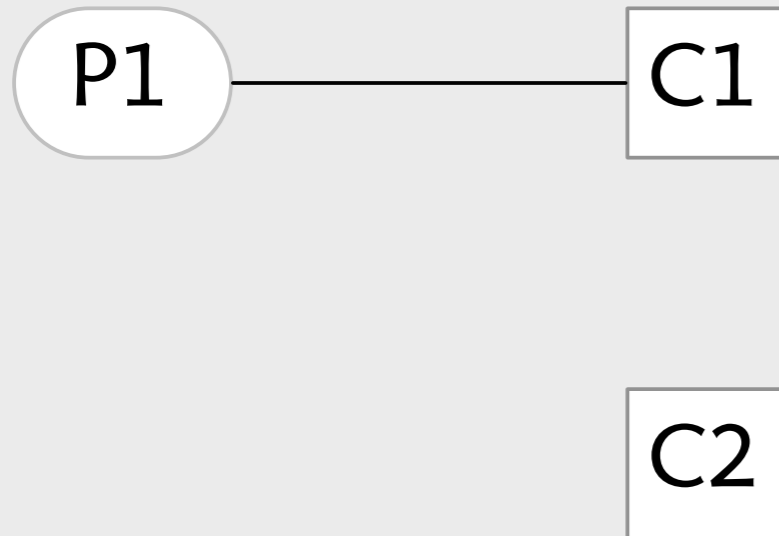

unmotivated concepts (more)

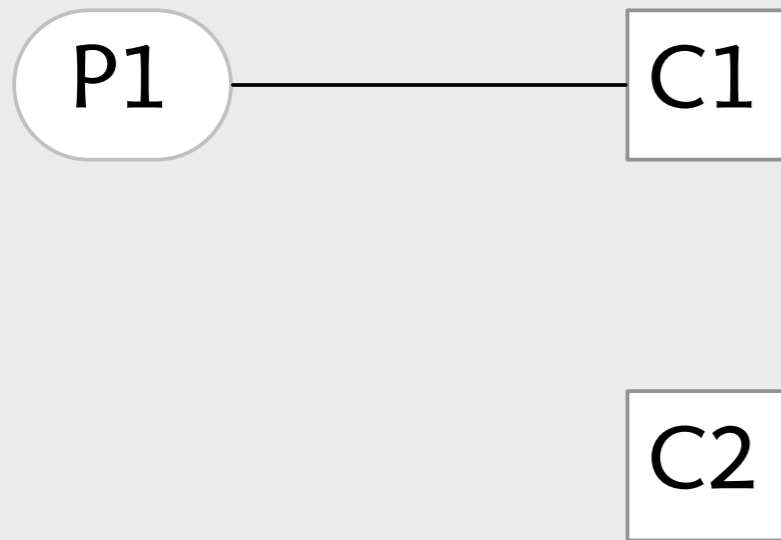

unmotivated concepts (more)

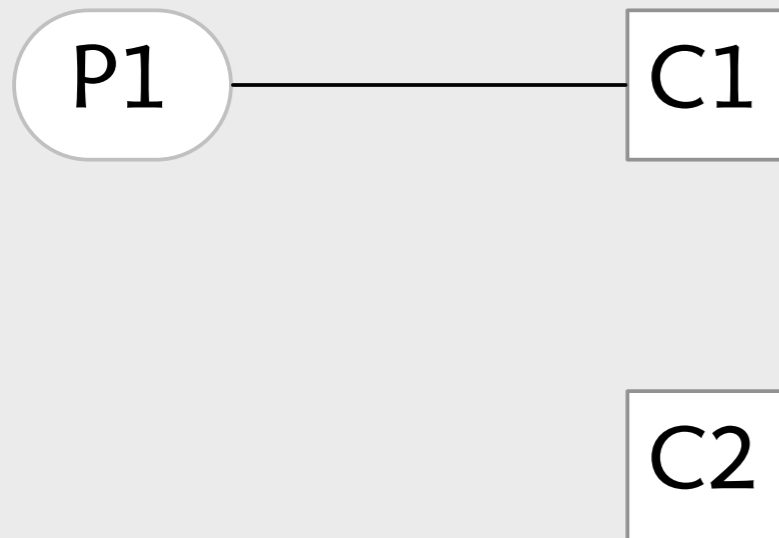

buffer (text editors)

Apple got rid of it

stash (Git)

addresses branching misfits

boxing (Java)

addresses primitives vs objects misfit

null (Javascript)

when undefined is too vague

redundant concepts

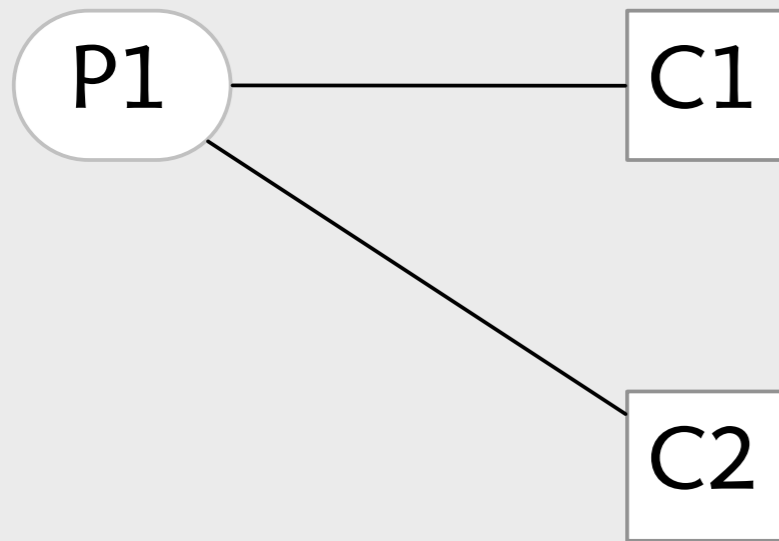

redundant concepts

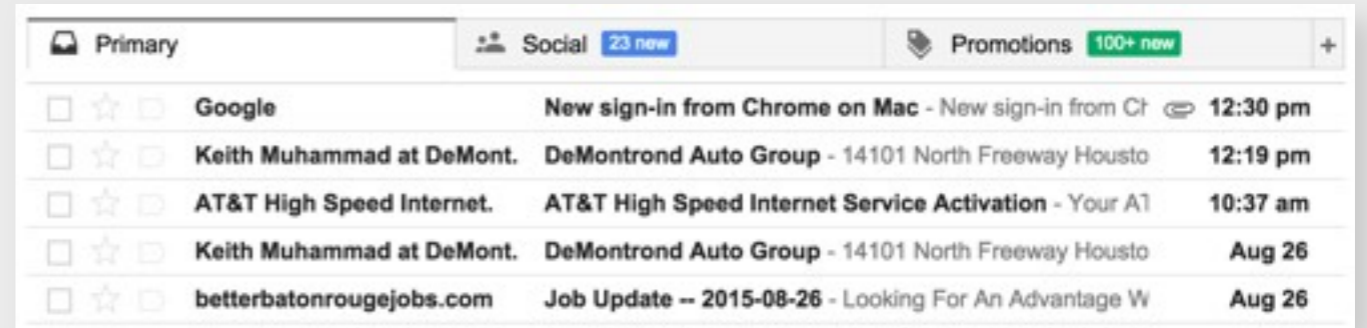
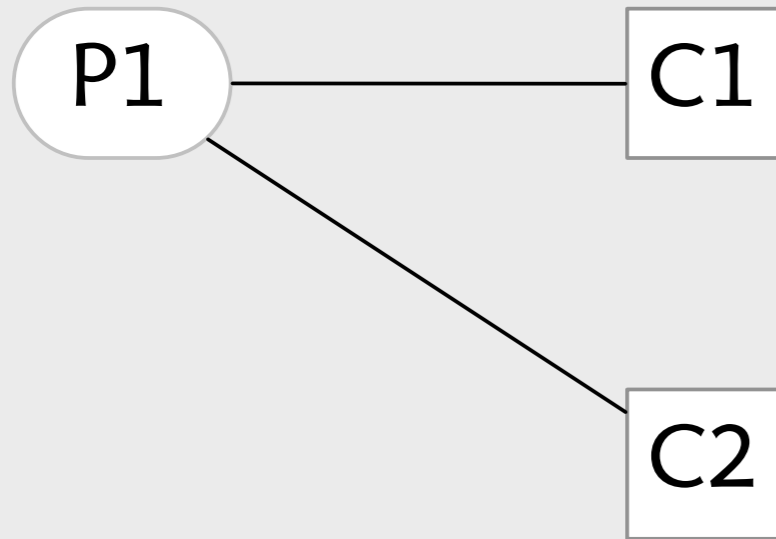

category in Gmail
a redundant concept

redundant concepts

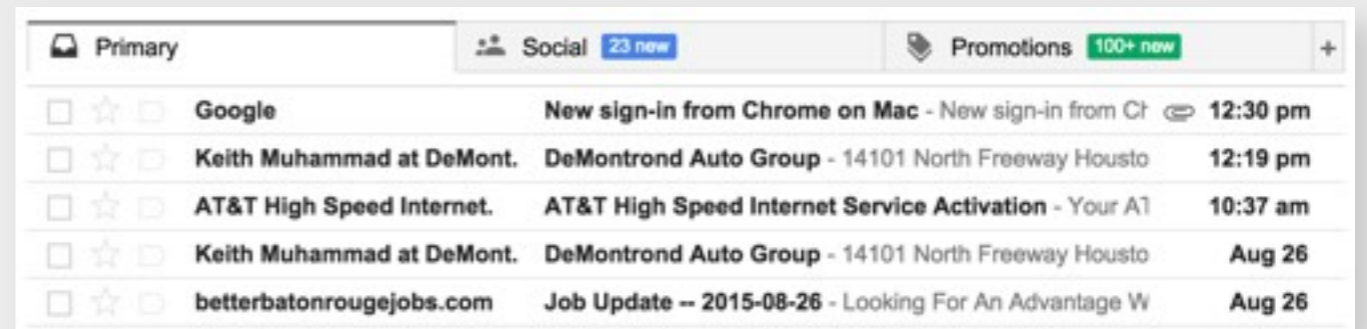
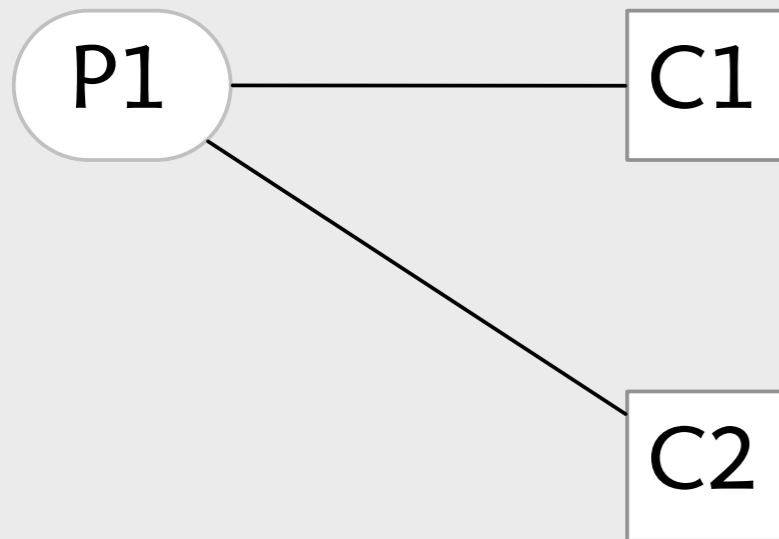

category in Gmail
a redundant concept

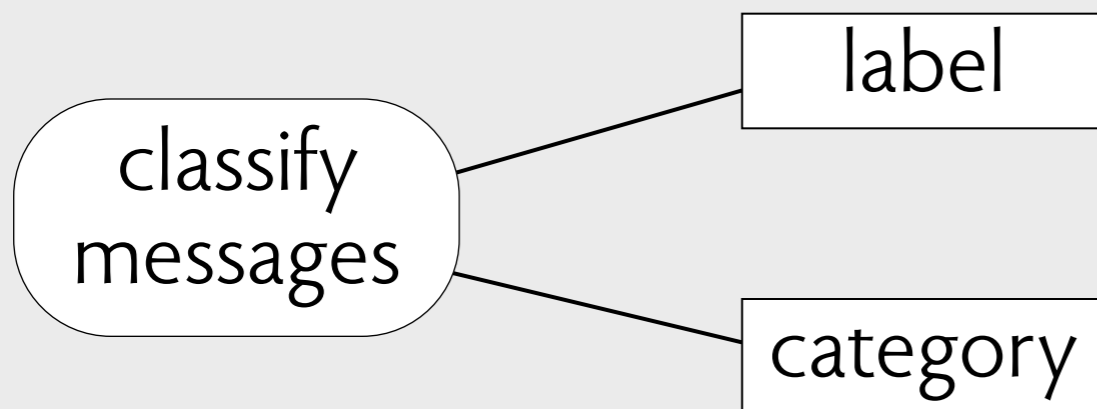

redundancy elimination in Acrobat

redundancy elimination in Acrobat

Acrobat 10

The screenshot displays the Adobe Acrobat 10.0 interface. The main window shows a PDF document titled "frizzle-permission.pdf" on page 1 of 1. The document content is a "Field Trip Permission Form" written in a typewriter font. The text includes a greeting "Dear Parents:", a request for a permission slip, a "Thank you!" message, and a statement of permission. At the bottom, there are fields for "Parents signature" and "Date". An "Add or Edit Text Box" tool is active, showing a typewriter icon and the font name "Courier" with a size of 10. The right sidebar contains the "Tools" panel with options like "Add Bookmark", "Attach a File", and "Add or Edit Text Box". The status bar at the bottom left indicates the page dimensions as 8.50 x 11.00 in.

frizzle-permission.pdf

Create

1 / 1 100%

Tools Comment Share

Field Trip Permission Form

Dear Parents:

Ms. Frizzle will again be taking her second grade class on an exciting field trip. Please sign and return the permission slip below.

Thank you!

Yes, I give permission for my child to go on the second grade "Touch and Feel" trip on Friday February 13th to the NastyCo Nuclear Dump. I understood that my child may encounter the normal risks of childhood play, including grazed knees, hurt feelings and exposure to toxic waste.

Parents signature Date

8.50 x 11.00 in

Typewriter

Typewriter

T

Courier

10

Pages

Content

Add Bookmark

Attach a File

Edit Text & Objects

Edit Document Text

Edit Object

Add or Edit Text Box

Add or Edit Interactive Object

Link

Button

Multimedia

Select Object

Forms

Recognize Text

redundancy elimination in Acrobat

Acrobat 10

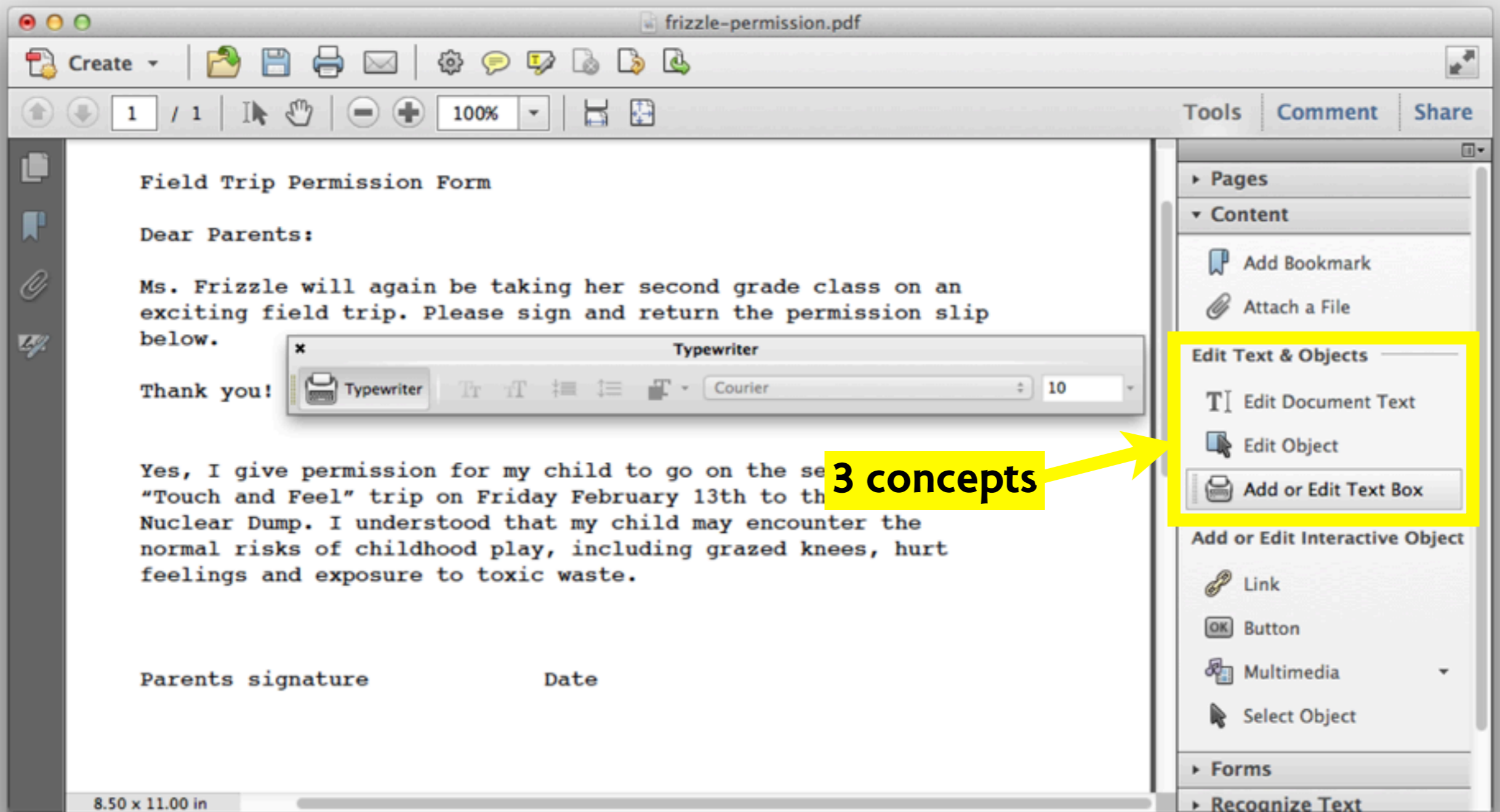

redundancy elimination in Acrobat

Acrobat 11

The screenshot displays the Adobe Acrobat 11 interface. The main window shows a PDF document titled "frizzle-permission.pdf" with the following text:

Ms. Frizzle will again be taking her second grade class on an exciting field trip. Please sign and return the permission slip below.

Thank you!

Yes, I give permission for my child to go on the second grade "Touch and Feel" trip on Friday February 13th to the NastyCo Nuclear Dump. I understood that my child may encounter the normal risks of childhood play, including grazed knees, hurt feelings and exposure to toxic waste.

Count Olaf
Parents signature

August 15, 2014
Date

The right-hand side of the interface shows the "Content Editing" toolbar, which includes the following options:

- Edit Text & Images
- Add Text (highlighted)
- Add Image
- Export File to...
- More Content
- Add or Edit Link
- Add Bookmark
- Attach a File
- Format (with a plus icon)
- AmericanTypewriter Me... (font dropdown)
- 10 (font size dropdown)
- Text alignment and formatting icons (bold, italic, underline, list, indent, link, unlink)

The bottom status bar indicates the page size is 8.50 x 11.00 in.

redundancy elimination in Acrobat

Acrobat 11

The screenshot displays the Adobe Acrobat 11 interface. The main window shows a PDF document titled "frizzle-permission.pdf" with the following text:

Ms. Frizzle will again be taking her second grade class on an exciting field trip. Please sign and return the permission slip below.

Thank you!

Yes, I give permission for my child to go on the second grade "Touch and Feel" trip on Friday February 13th to the NastyCo Nuclear Dump. I understood that my child may encounter the normal risks of childhood play, including grazed knees, hurt feelings and exposure to toxic waste.

Count Olaf
Parents signature

August 15, 2014
Date

The right-hand side of the interface shows the "Tools" palette. The "Content Editing" section is expanded, and the "Edit Text & Images" tool is highlighted with a yellow box. A yellow arrow points from a yellow box containing the text "1 concept" to the "Edit Text & Images" tool. Below the arrow, the text "1 concept" is also highlighted in a yellow box.

1 concept

overloaded concepts

No one can serve two masters. Either you will hate the one and love the other, or you will be devoted to the one and despise the other. [Matthew 6:24]

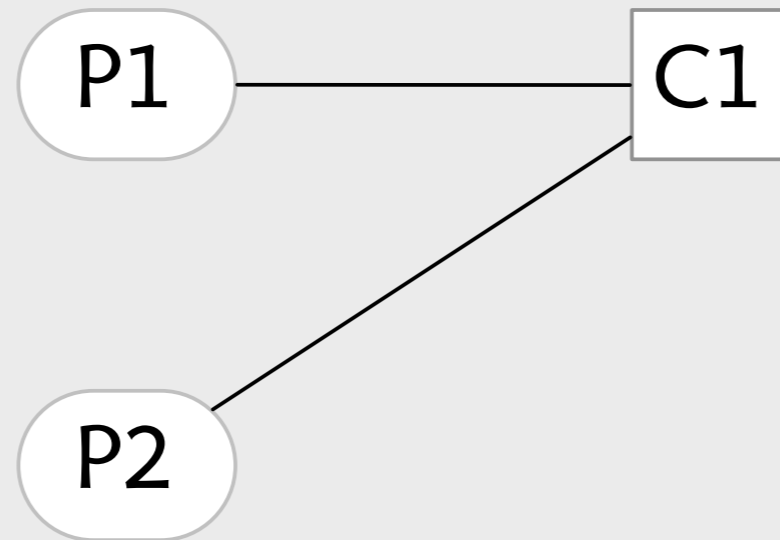

overloaded concepts

No one can serve two masters. Either you will hate the one and love the other, or you will be devoted to the one and despise the other. [Matthew 6:24]

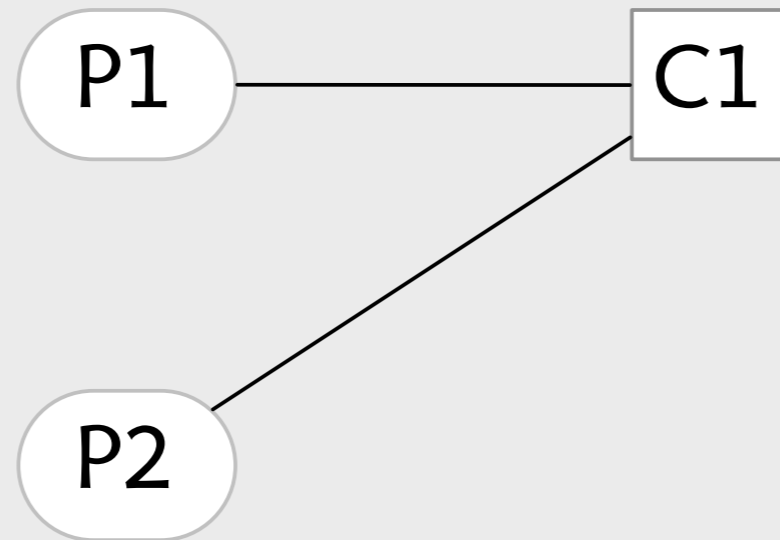

3 forms of overloading:

piggybacking new purpose hacked onto old concept

false convergence two purposes looked the same

emergent purpose users found second purpose for concept

piggybacking fuji camera

new purpose hacked onto old concept

piggybacking fuji camera

new purpose hacked onto old concept



A screenshot of a camera's menu showing various image size and aspect ratio options. The menu is organized into rows, each with a mode letter (L, M, S), an aspect ratio, and a corresponding image size value. The 'L' mode options are highlighted with a white background.

L	3:2	664
L	16:9	681
L	1:1	702
M	3:2	707
M	16:9	719
M	1:1	734
S	3:2	746

image size

aspect ratio piggybacked
on JPEG dimensions

piggybacking epson driver

piggybacking epson driver

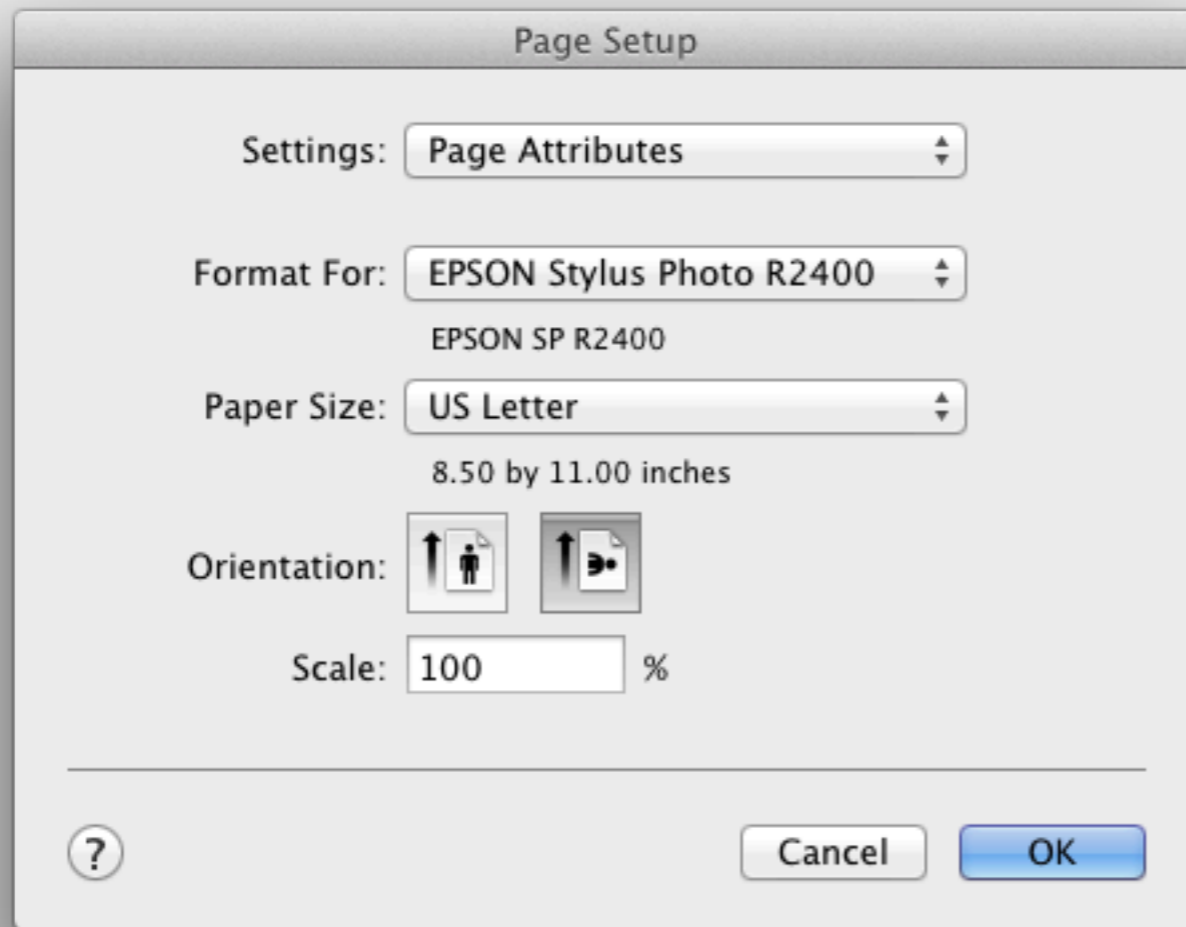

piggybacking epson driver

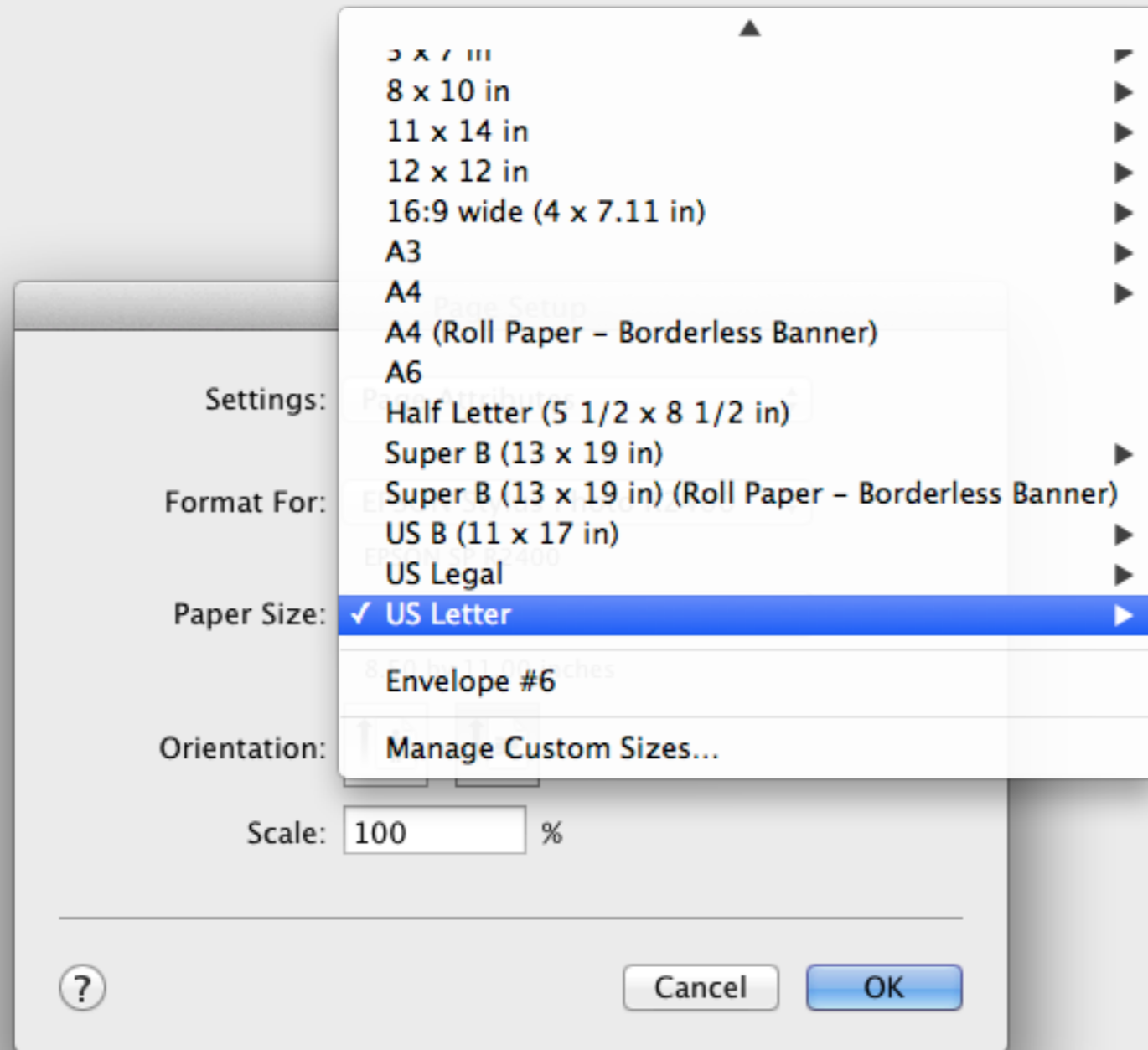

piggybacking epson driver

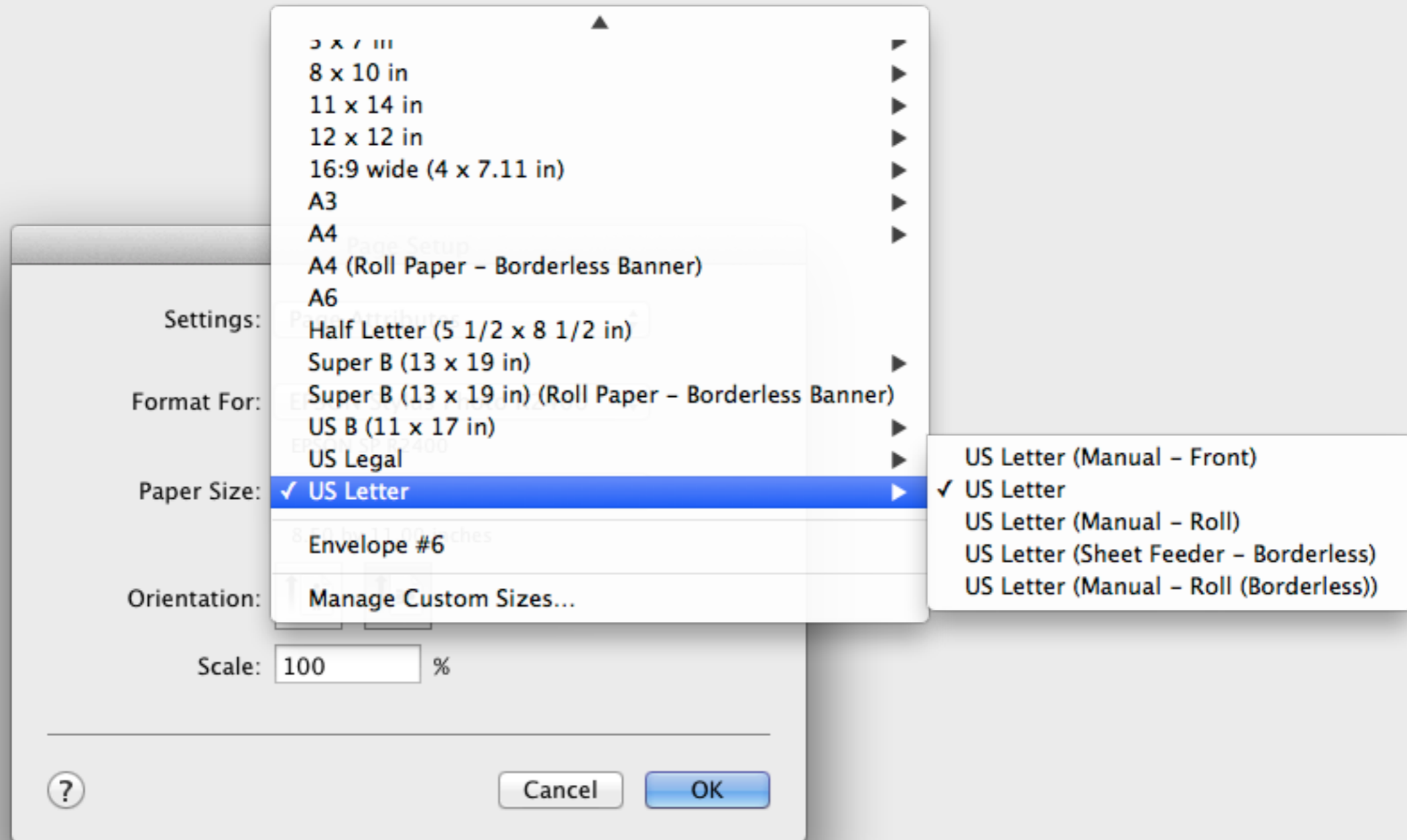

piggybacking epson driver

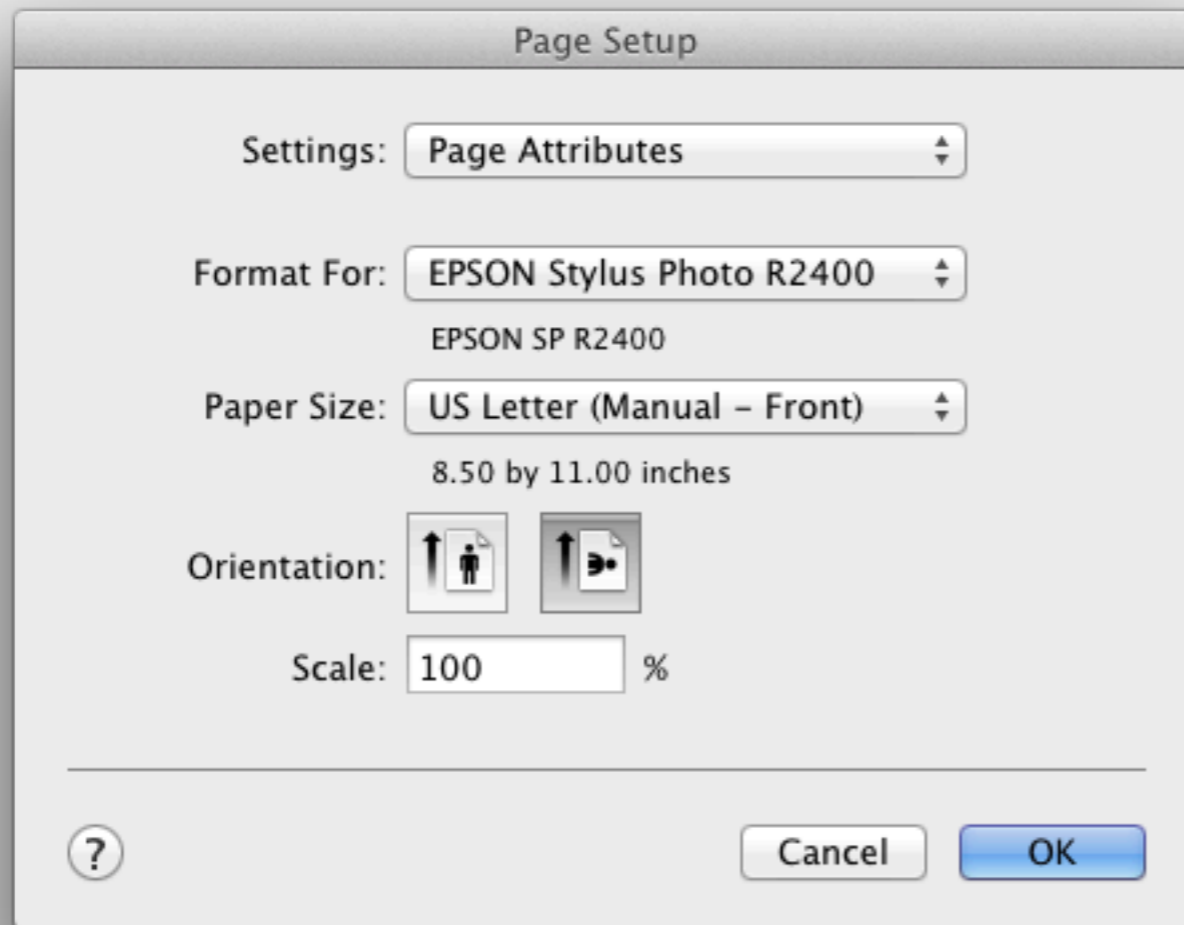

piggybacking epson driver

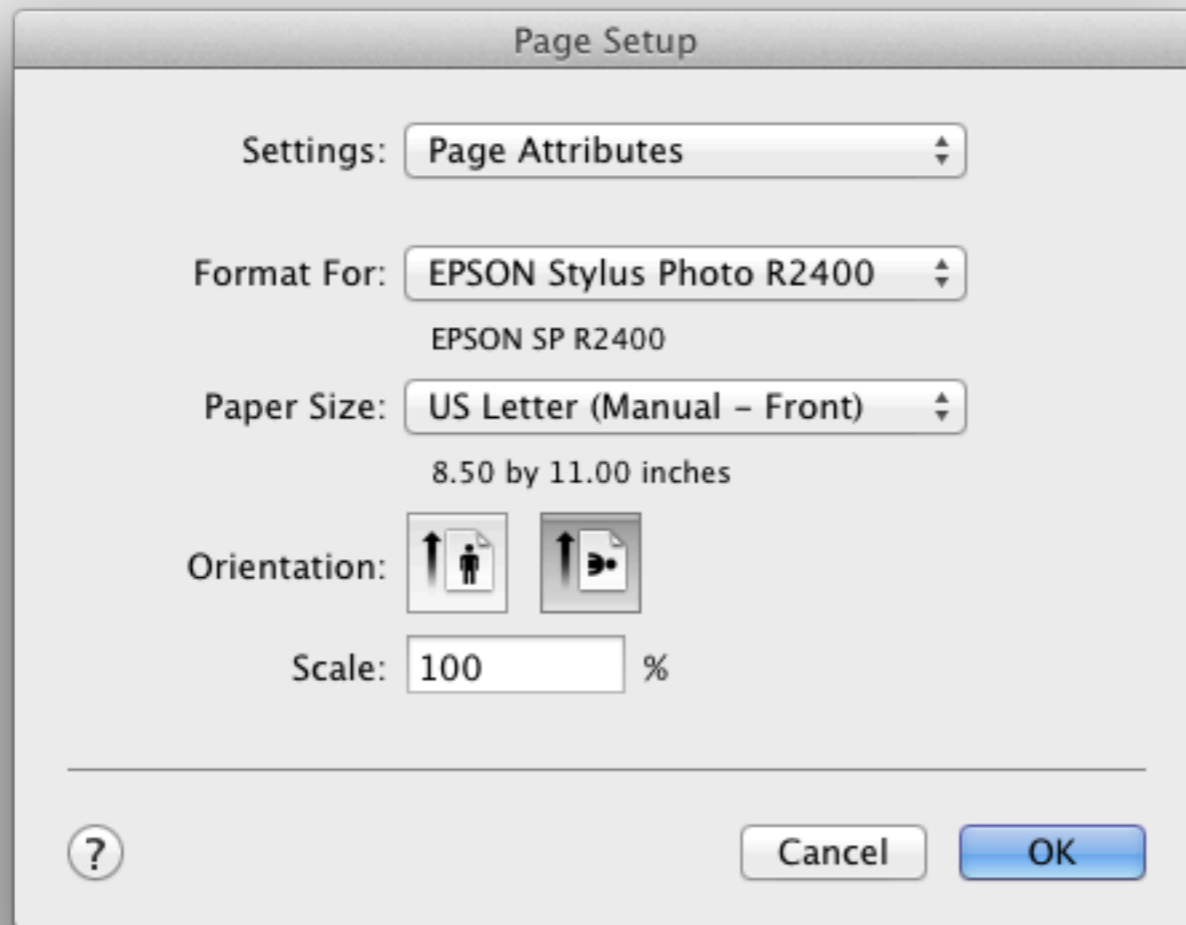

result: can't create custom size for front loading
also, page size presets in Lightroom hold feed setting

false convergence

two purposes looked the same

Performance Review Form 2016

Performance Summary

Evaluate and discuss the employee's performance. Base your evaluation on the position requirements, [MIT Core Competencies](#), achievement of the goals established during the past year, and your assessment of the employee's accomplishments.

Goal Setting

State and discuss the expectations and goals for the upcoming review period. Give examples of how these goals can be met (e.g., training). How will you support the employee to accomplish these goals? [Reference here](#)

evaluation & goal setting
incompatible purposes

false convergence

two purposes looked the same



filter incoming posts
control access to my posts
distinct purposes

2011: Facebook added
subscribe/follow

emergent purpose

users find second purpose for concept

emergent purpose

users find second purpose for concept

To: Daniel Jackson <dnj@mit.edu>

Re: Catch me if you can in real life!

initial purpose: summarize content

emergent purpose

users find second purpose for concept

To: Daniel Jackson <dnj@mit.edu>

Re: Catch me if you can in real life!

initial purpose: summarize content

To: csail-related@lists.csail.mit.edu

Re: [csail-related] turn off the lights?

emergent purpose: show sender
if you bcc a list, subject reveals to-address

thanks to Shriram Krishnamurthi

emergent purpose

users find second purpose for concept

To: Daniel Jackson <dnj@mit.edu>

Re: Catch me if you can in real life!

initial purpose: summarize content

To: csail-related@lists.csail.mit.edu

Re: [csail-related] turn off the lights?

emergent purpose: show sender
if you bcc a list, subject reveals to-address

thanks to Shriram Krishnamurthi

To: Daniel Jackson <dnj@mit.edu>

your trip reservation

emergent purpose: group by conversation
can't label reservations from Expedia by trip

thanks to Eunsuk Kang

gitless:
a case study

GIT

|<

< PREV

RANDOM

NEXT >

>|

THIS IS GIT. IT TRACKS COLLABORATIVE WORK ON PROJECTS THROUGH A BEAUTIFUL DISTRIBUTED GRAPH THEORY TREE MODEL.

COOL. HOW DO WE USE IT?

NO IDEA. JUST MEMORIZE THESE SHELL COMMANDS AND TYPE THEM TO SYNC UP. IF YOU GET ERRORS, SAVE YOUR WORK ELSEWHERE, DELETE THE PROJECT, AND DOWNLOAD A FRESH COPY.



|<

< PREV

RANDOM

NEXT >

>|

PERMANENT LINK TO THIS COMIC: [HTTP://XKCD.COM/1597/](http://xkcd.com/1597/)

IMAGE URL (FOR HOTLINKING/EMBEDDING): [HTTP://IMGS.XKCD.COM/COMICS/GIT.PNG](http://imgs.xkcd.com/comics/git.png)

gitless: a reworking of git

Gitless: a version control system

Fork me on GitHub

About Gitless

Gitless is an experimental version control system built on top of Git. Many people complain that Git is hard to use. We think the problem lies deeper than the user interface, in the concepts underlying Git. Gitless is an experiment to see what happens if you put a simple veneer on an app that changes the underlying concepts. Because Gitless is implemented on top of Git (could be considered what Git pros call a "porcelain" of Git), you can always fall back on Git. And of course your coworkers you share a repo with need never know that you're not a Git aficionado.

Check out the [documentation](#) to get started. If you are a novice user that never used any version control system the documentation should be enough to get you started. If you are a Git pro looking to see what's different from your beloved Git you'll be able to spot the differences by glancing through the [Gitless vs. Git](#) section.

Download

- [Mac OS X Binary \(.tar.gz\)](#)
- [Linux Binary \(.tar.gz\)](#)
- [Source Code \(.tar.gz\)](#)

For installation instructions [see the readme file](#). After installation, you should be able to execute the `gl` command. The current Gitless version is 0.7 which was released on 4/2015 ([release notes](#)).

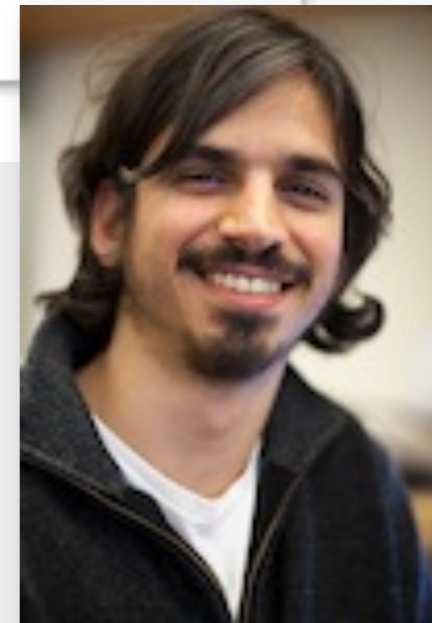

Santiago
Perez De Rosso

example: branch

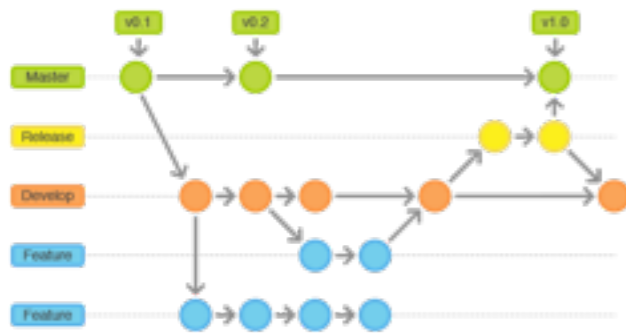

concept: branch

example: branch

purpose: support independent line of development

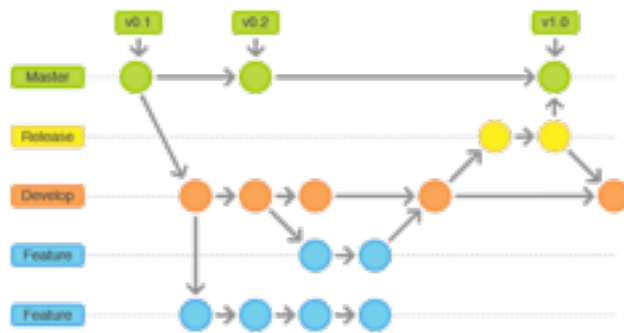

concept: branch

example: branch

purpose: support independent line of development

operational principle: when you switch branches, your working directory is synchronized with the new branch, and you can make and commit changes which will be invisible on other branches; when you're done, you can merge the branch into the master branch...

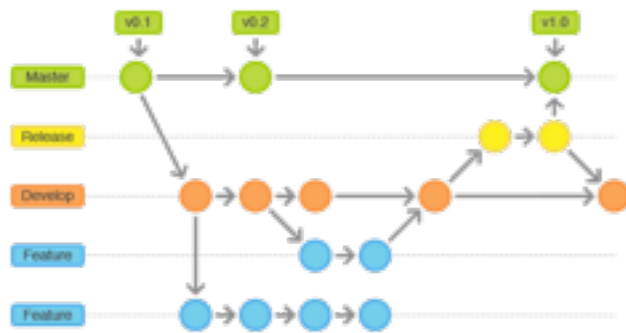

concept: branch

example: branch



concept: branch

purpose: support independent line of development

operational principle: when you switch branches, your working directory is synchronized with the new branch, and you can make and commit changes which will be invisible on other branches; when you're done, you can merge the branch into the master branch...

misfit: can't switch branches with uncommitted changes; can stash, but only if no conflicts...

example: branch



concept: branch

purpose: support independent line of development

operational principle: when you switch branches, your working directory is synchronized with the new branch, and you can make and commit changes which will be invisible on other branches; when you're done, you can merge the branch into the master branch...

misfit: can't switch branches with uncommitted changes; can stash, but only if no conflicts...

fix: give branch its own working directory; when you switch branches, the working directory changes too, and the working directory associated with the previous branch is preserved

results of a user study

I enjoyed using Gitless
 I found Gitless to be easier to learn than Git
 I found Gitless to be easier to use than Git
 I would continue using Gitless if I could

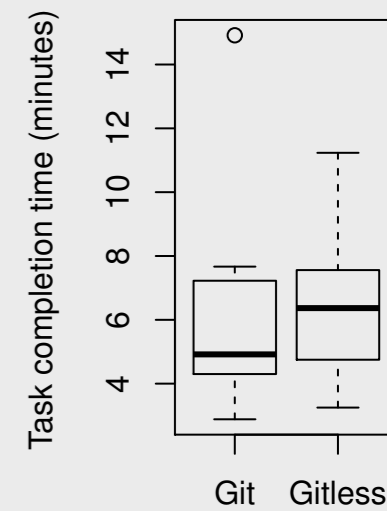
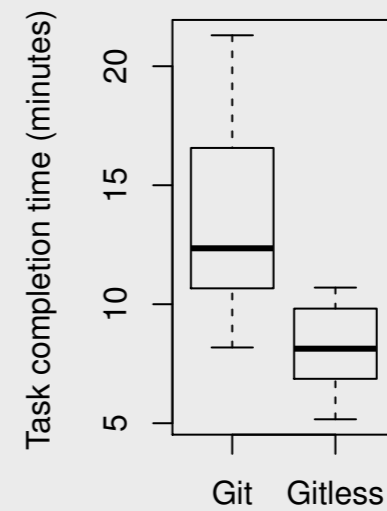
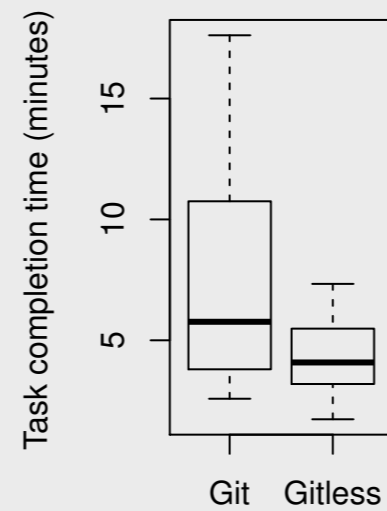
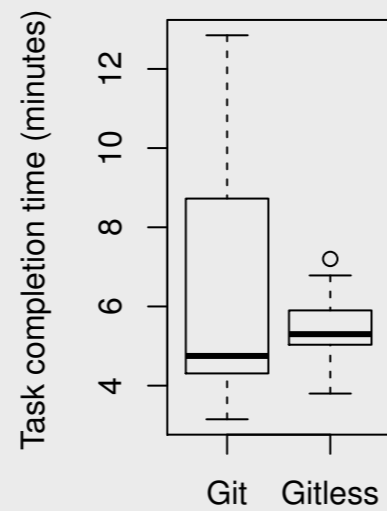
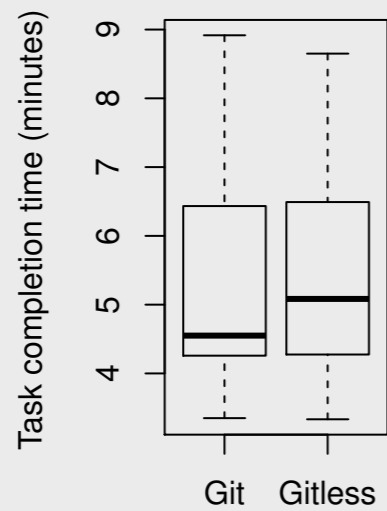
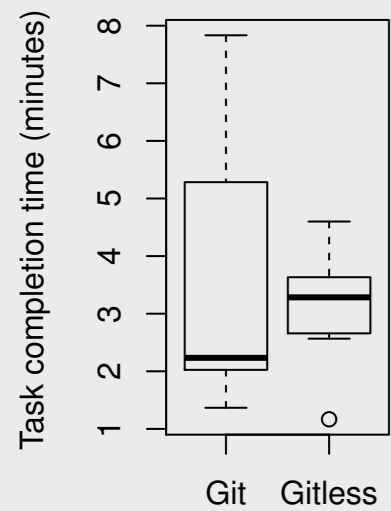
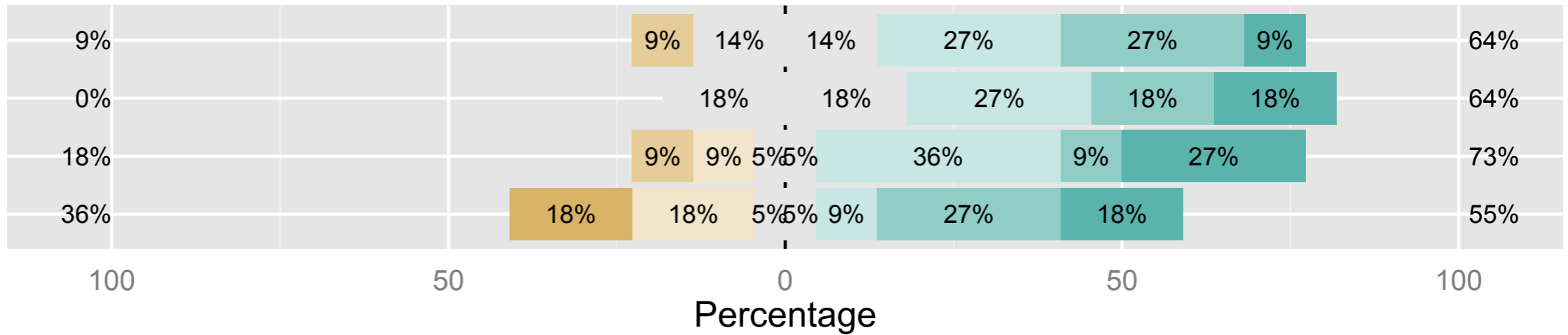

conclusions

	designer	engineer
elements	?	function, object, type
criteria	?	decoupling & localization
goals	learnable, effective, tolerant	maintainable, correct, fast

	designer	engineer
elements	concepts, purposes	function, object, type
criteria	?	decoupling & localization
goals	learnable, effective, tolerant	maintainable, correct, fast

	designer	engineer
elements	concepts, purposes	function, object, type
criteria	1:1 = concept:purpose	decoupling & localization
goals	learnable, effective, tolerant	maintainable, correct, fast



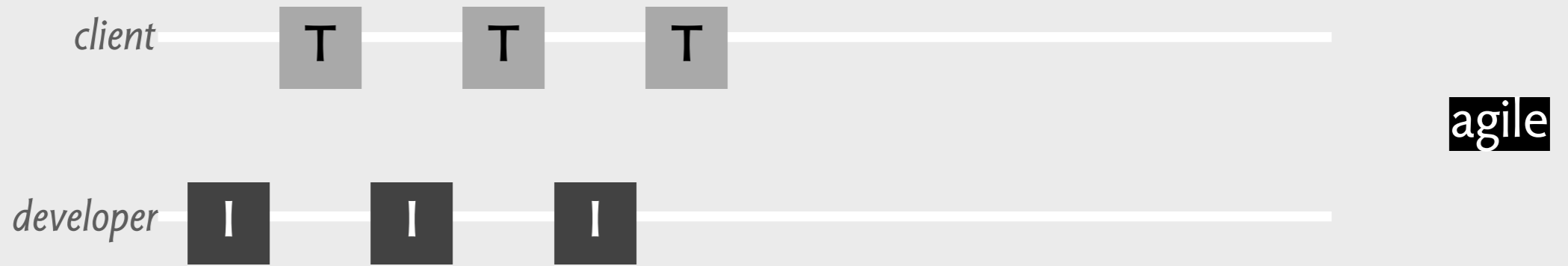
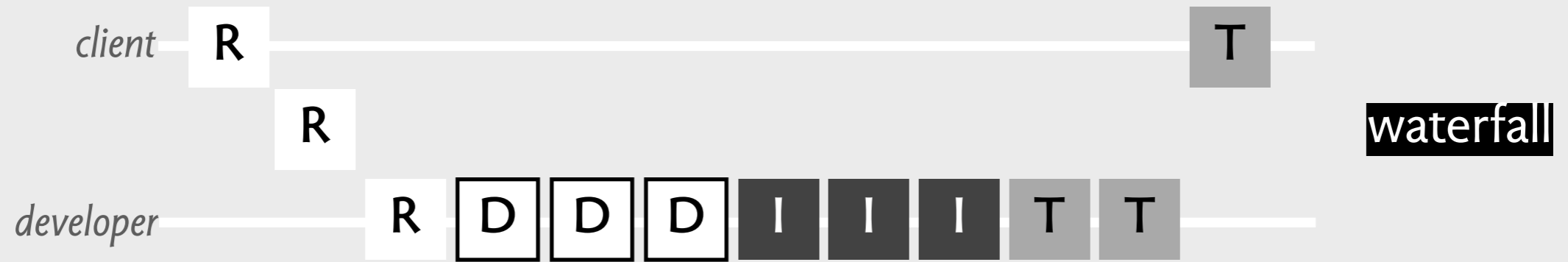

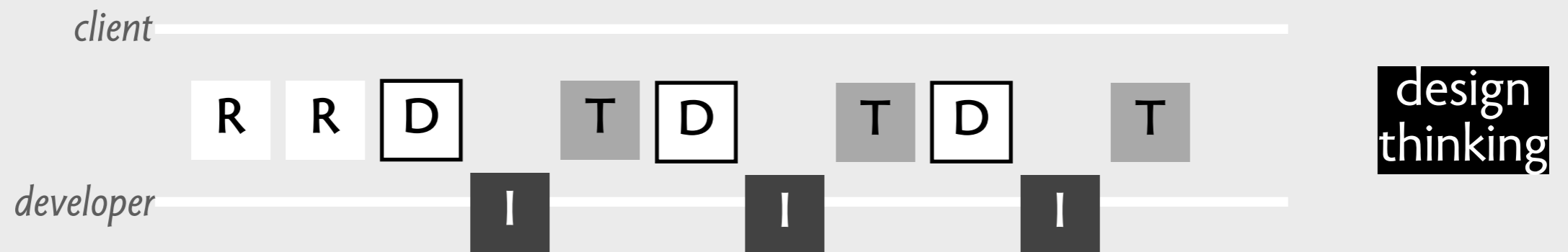
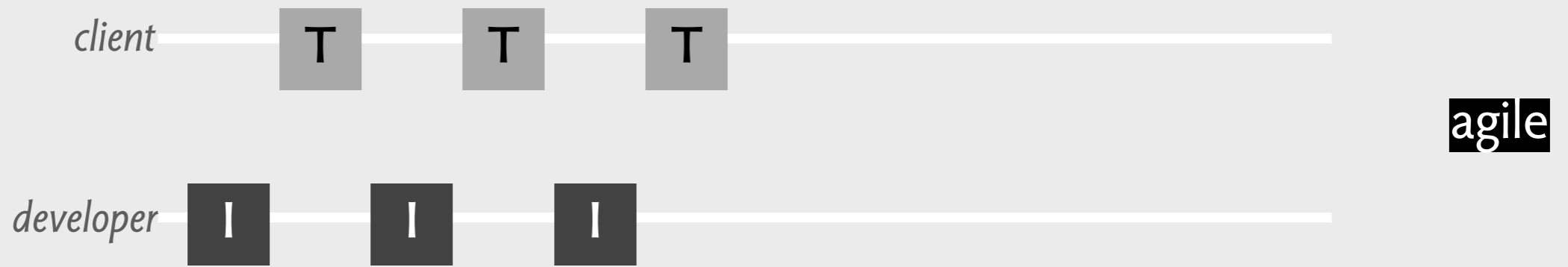
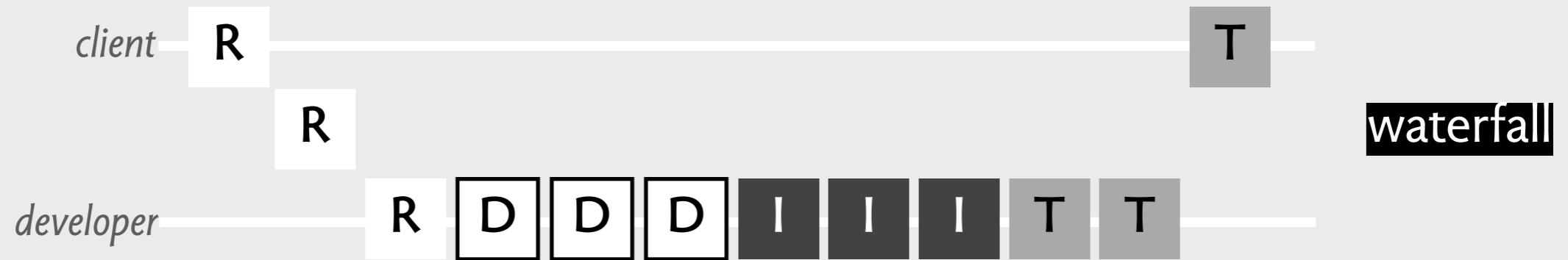

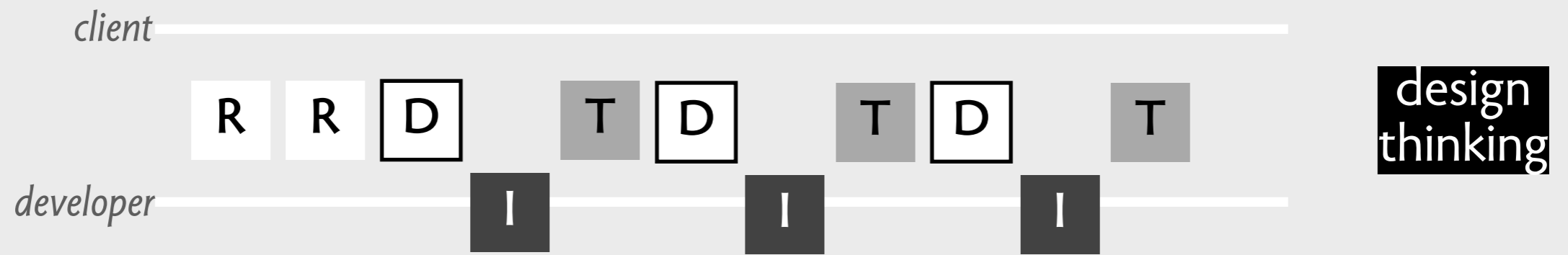
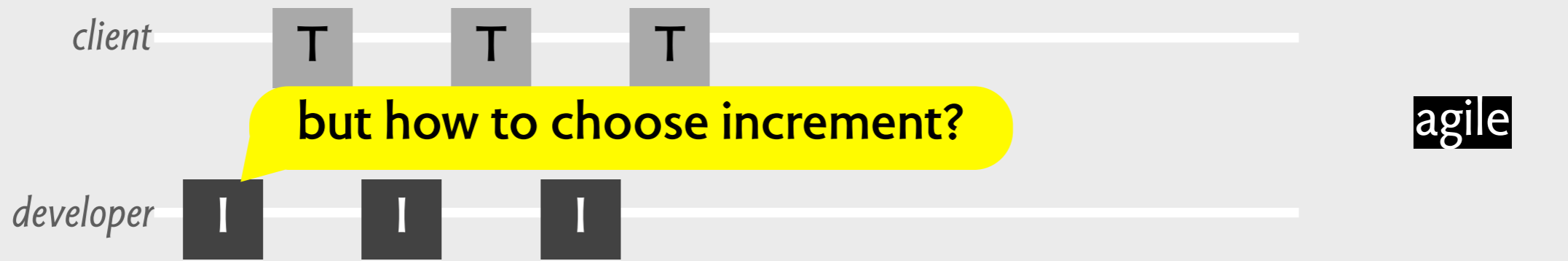
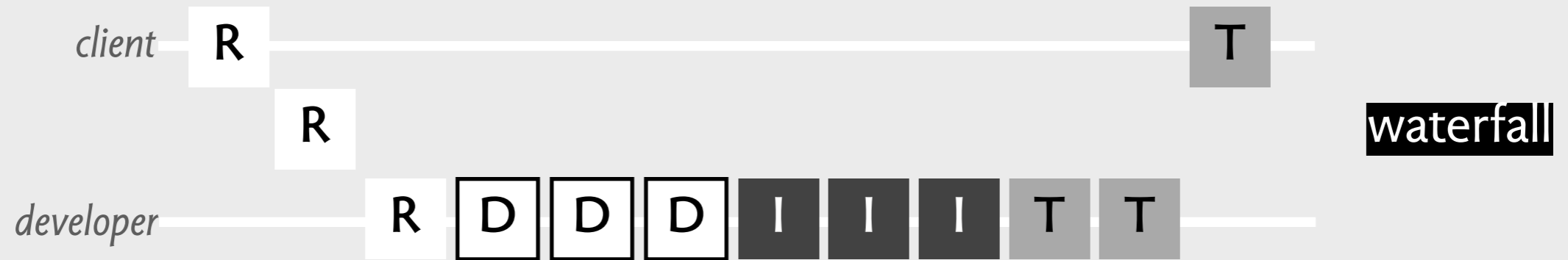

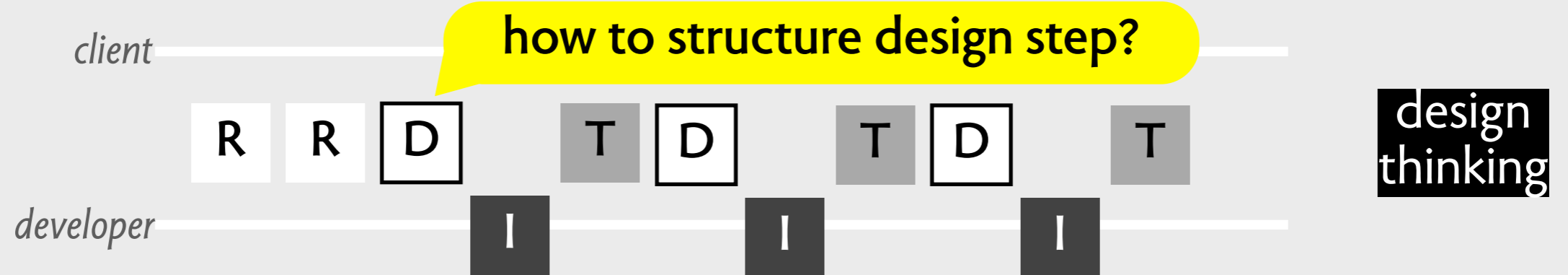
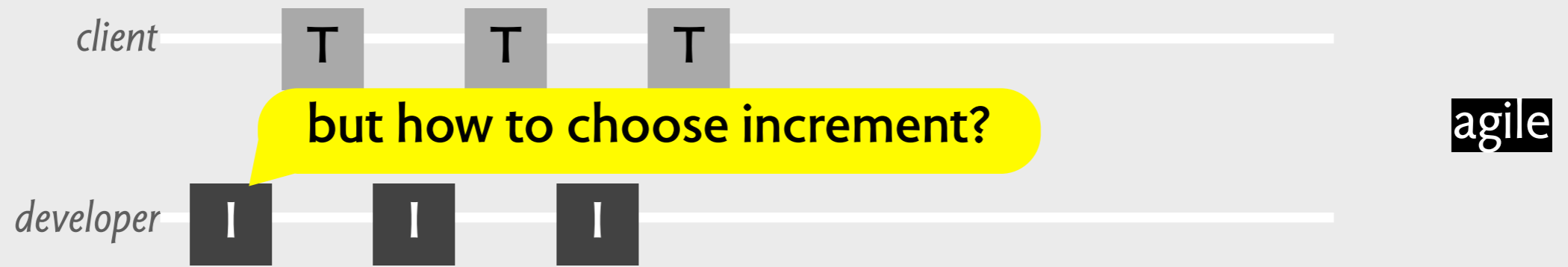
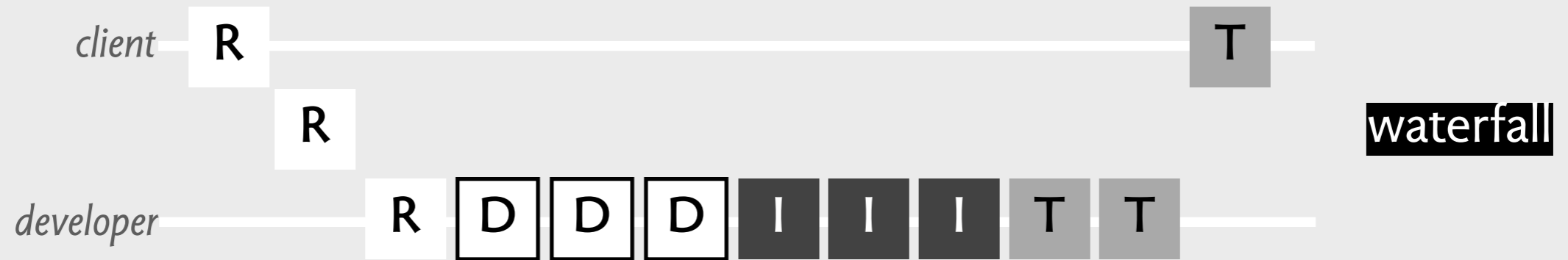

a software design approach

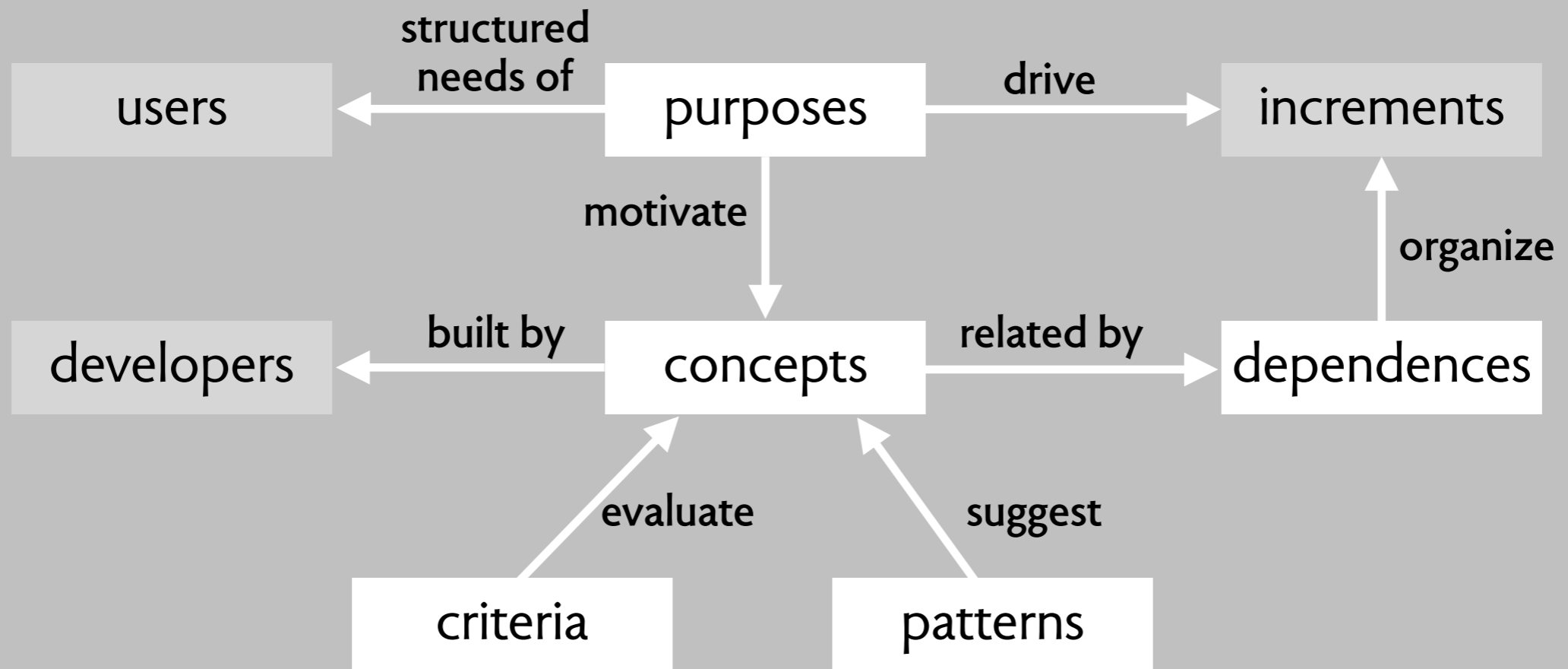

backup
material

a new view

a common view of software design



UI design
soft & human
about presentation



programming
hard & technical
about content

a better view of software design

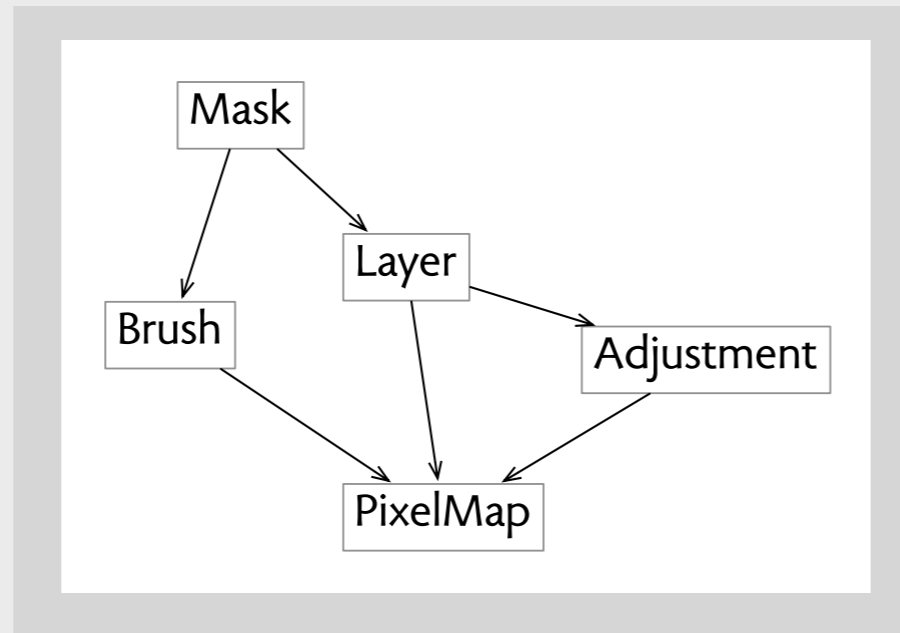

conceptual design:
essential concepts
& behavior

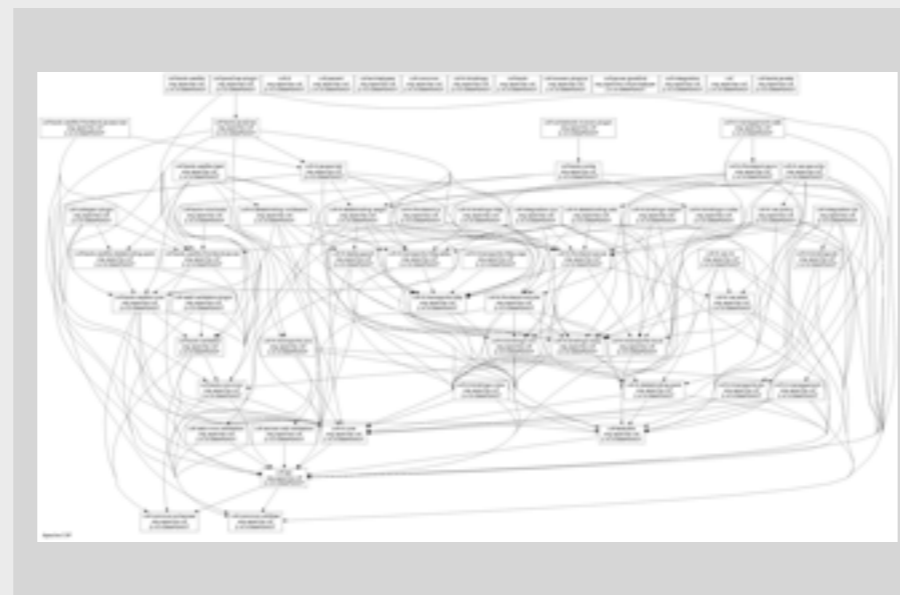

representation design:
organization & performance

designing
on purpose

design is driven by purpose

design is driven by purpose

purpose

design is driven by purpose

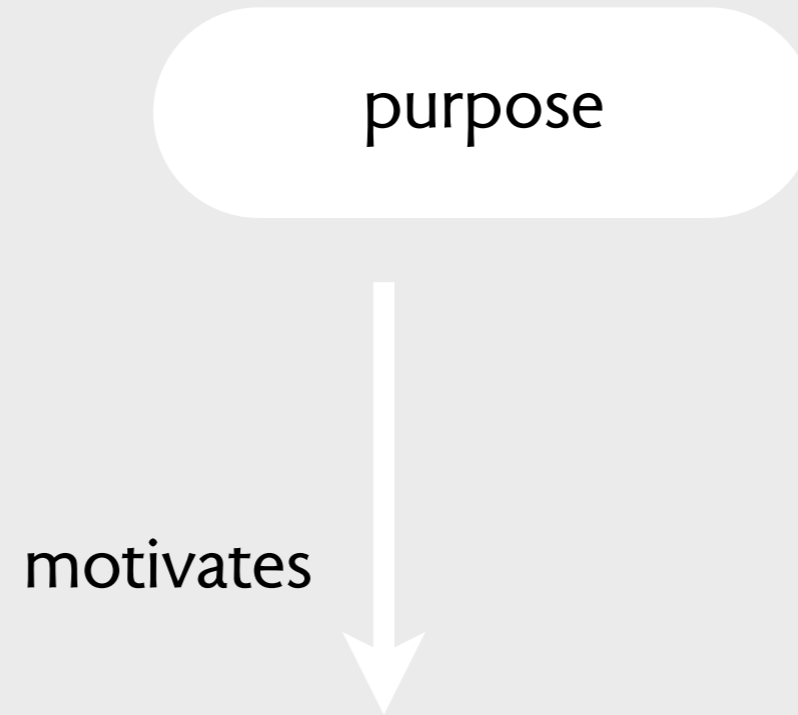

design is driven by purpose

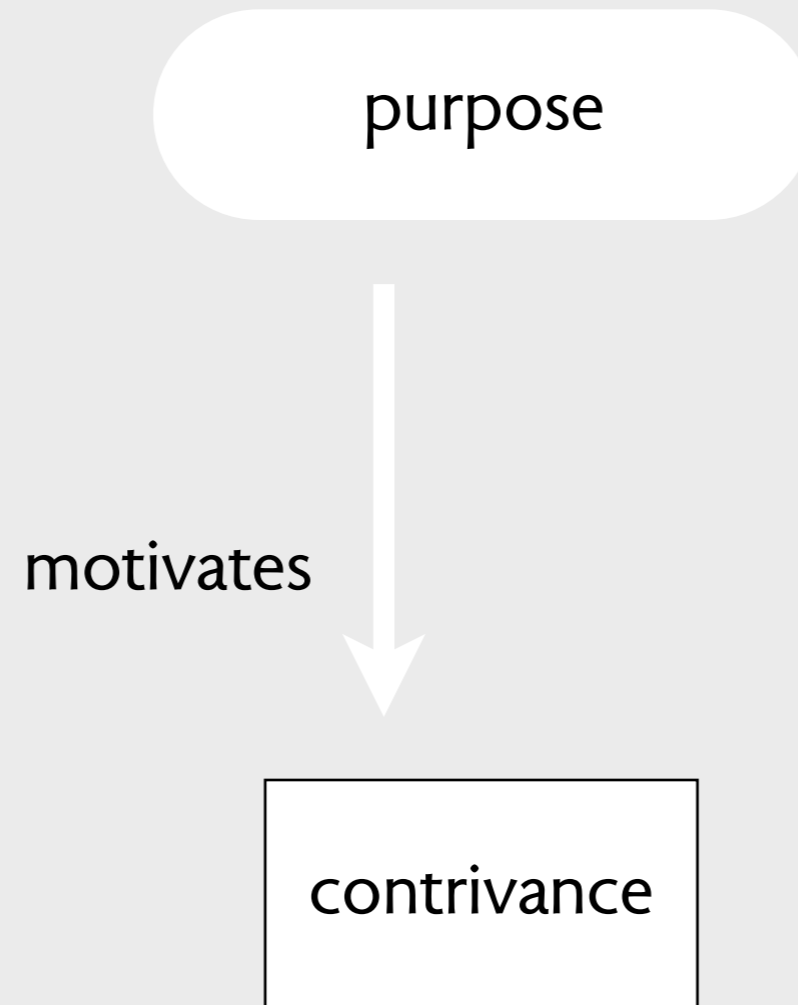

design is driven by purpose

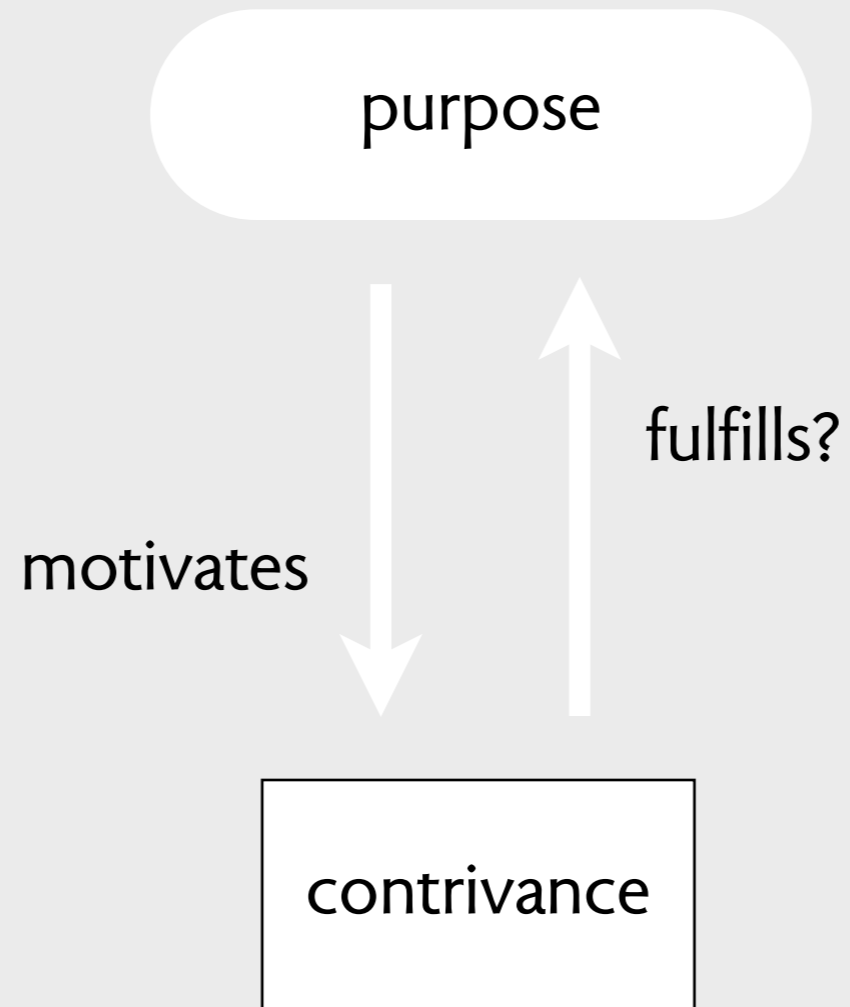

design is driven by purpose

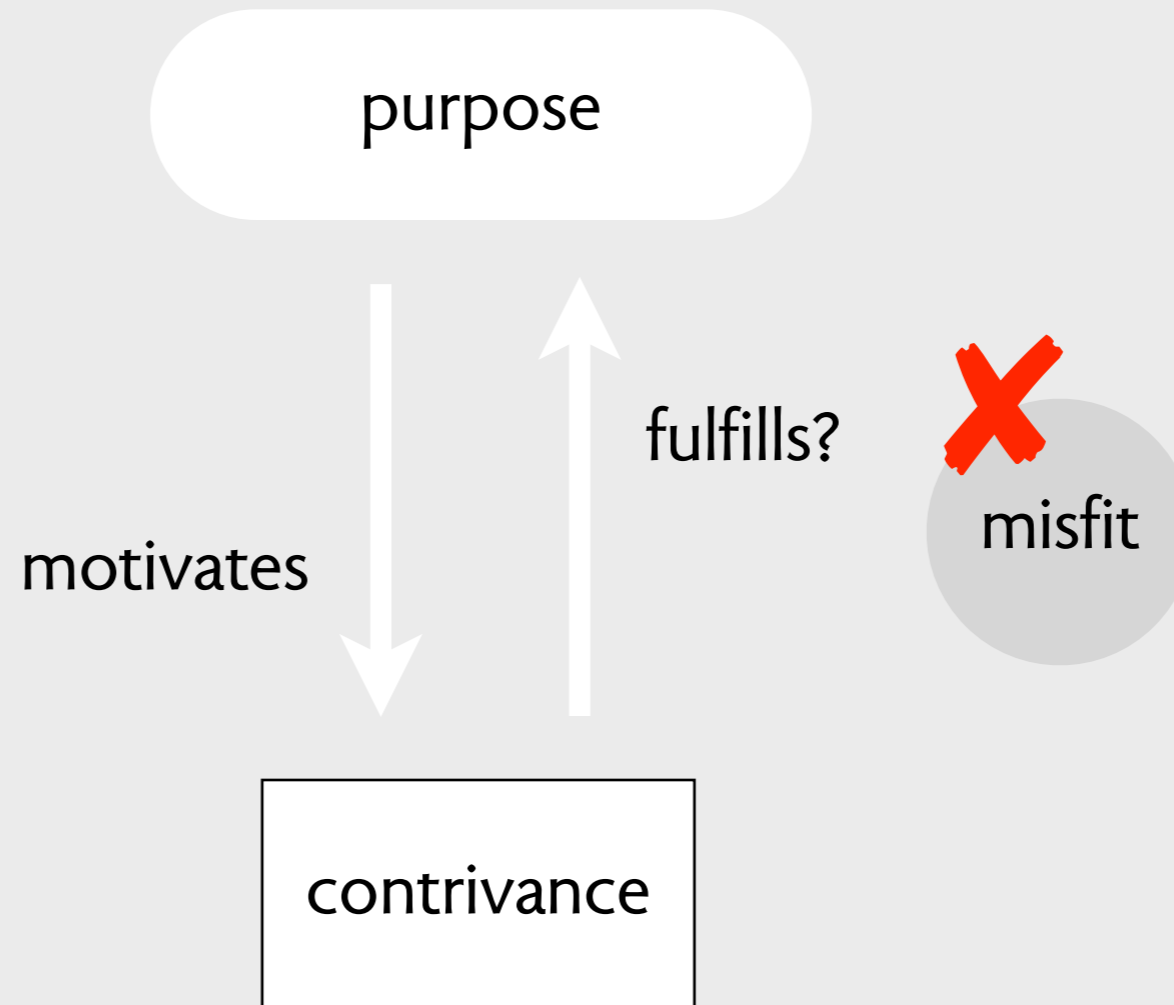

design is driven by purpose

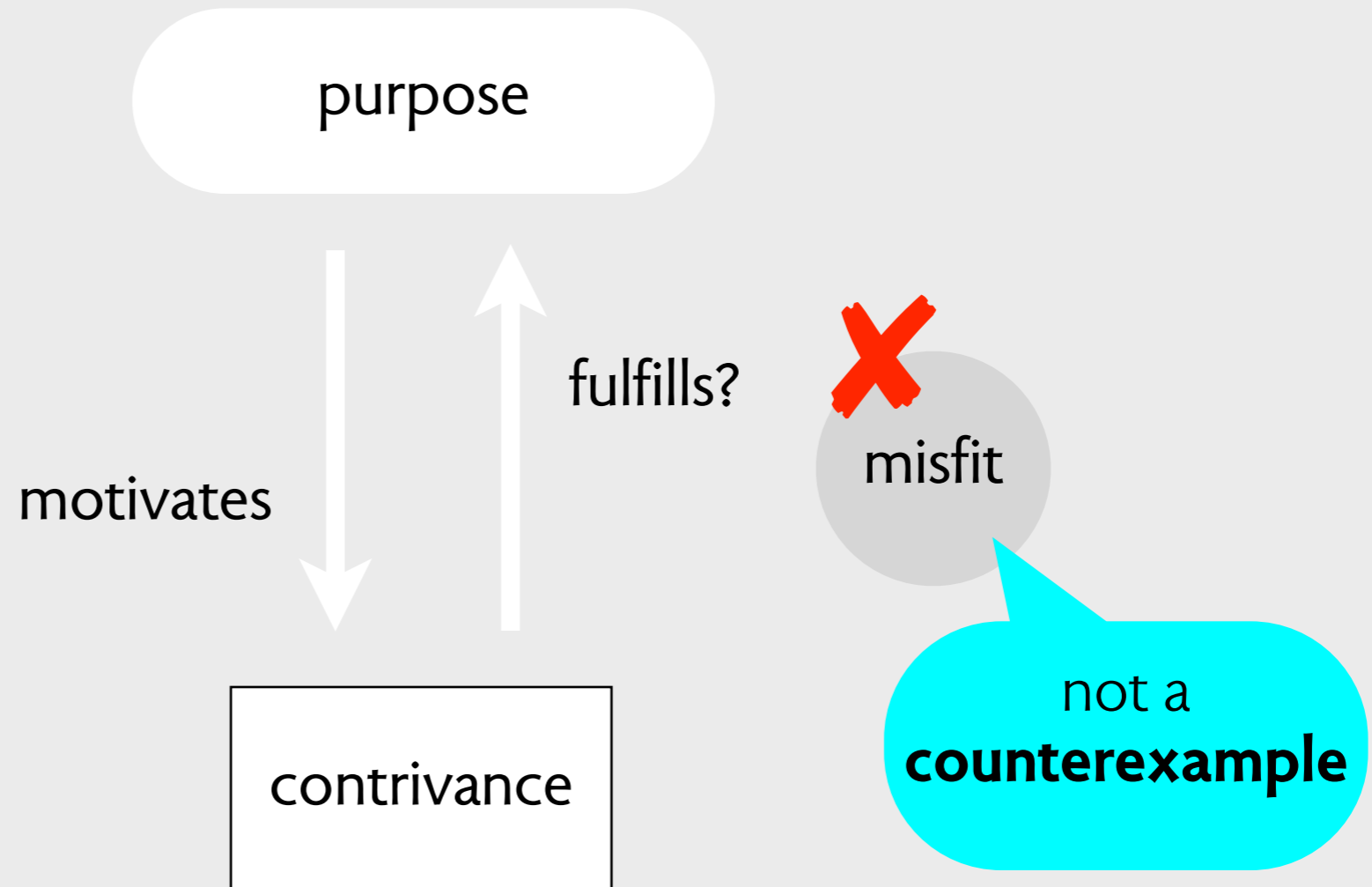

example: a photo wall

example: a photo wall

changeable wall
display of prints

example: a photo wall

changeable wall
display of prints

motivates



example: a photo wall

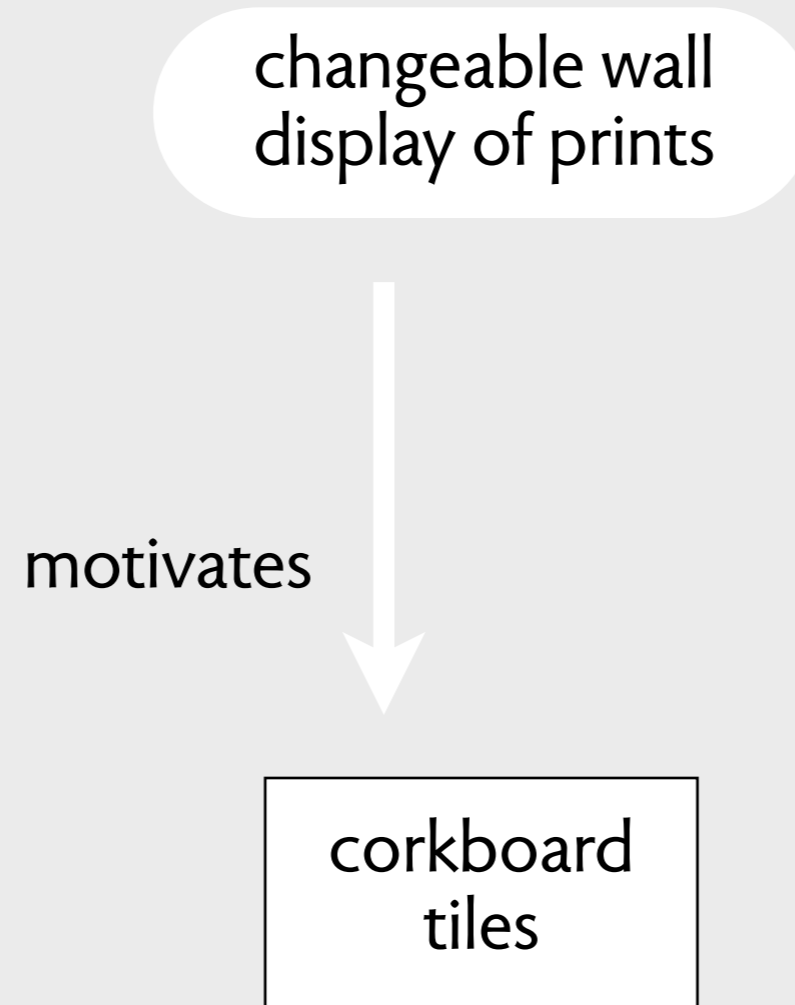

example: a photo wall

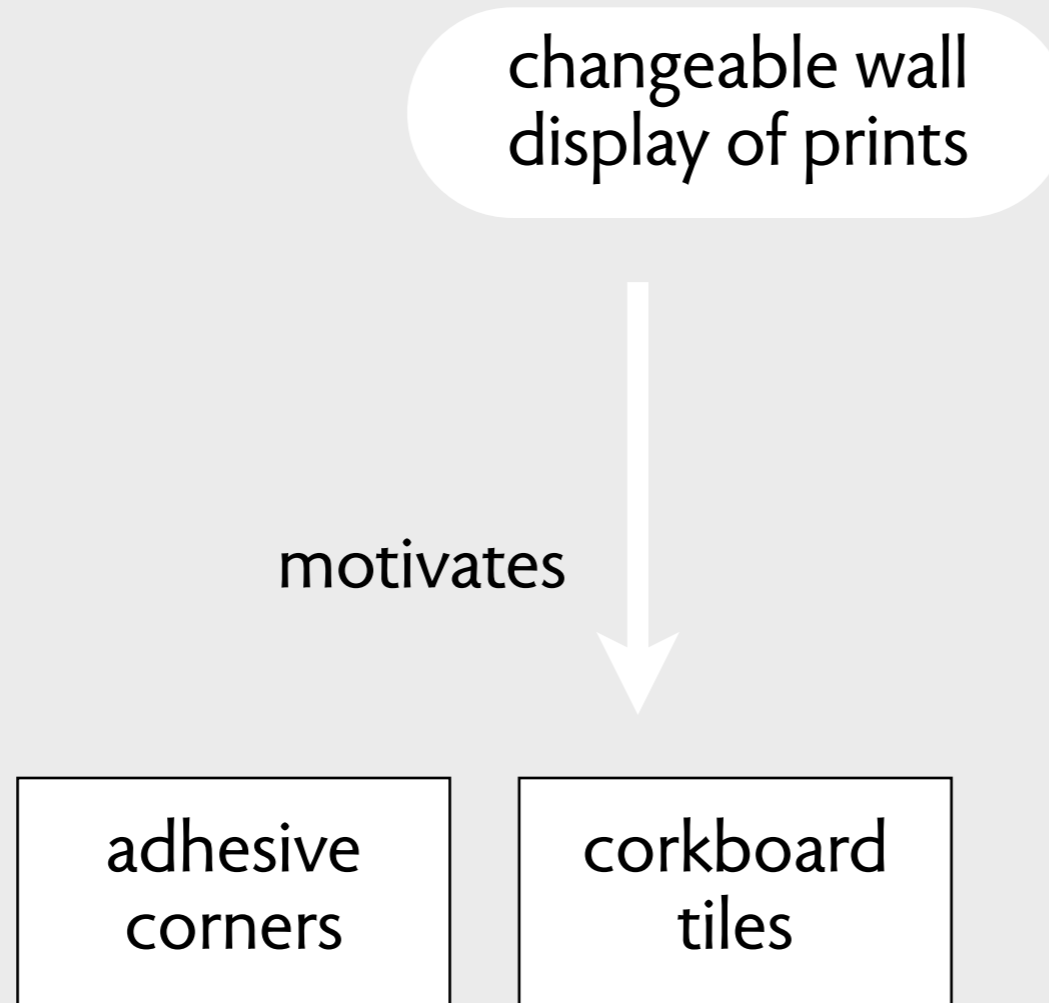

example: a photo wall

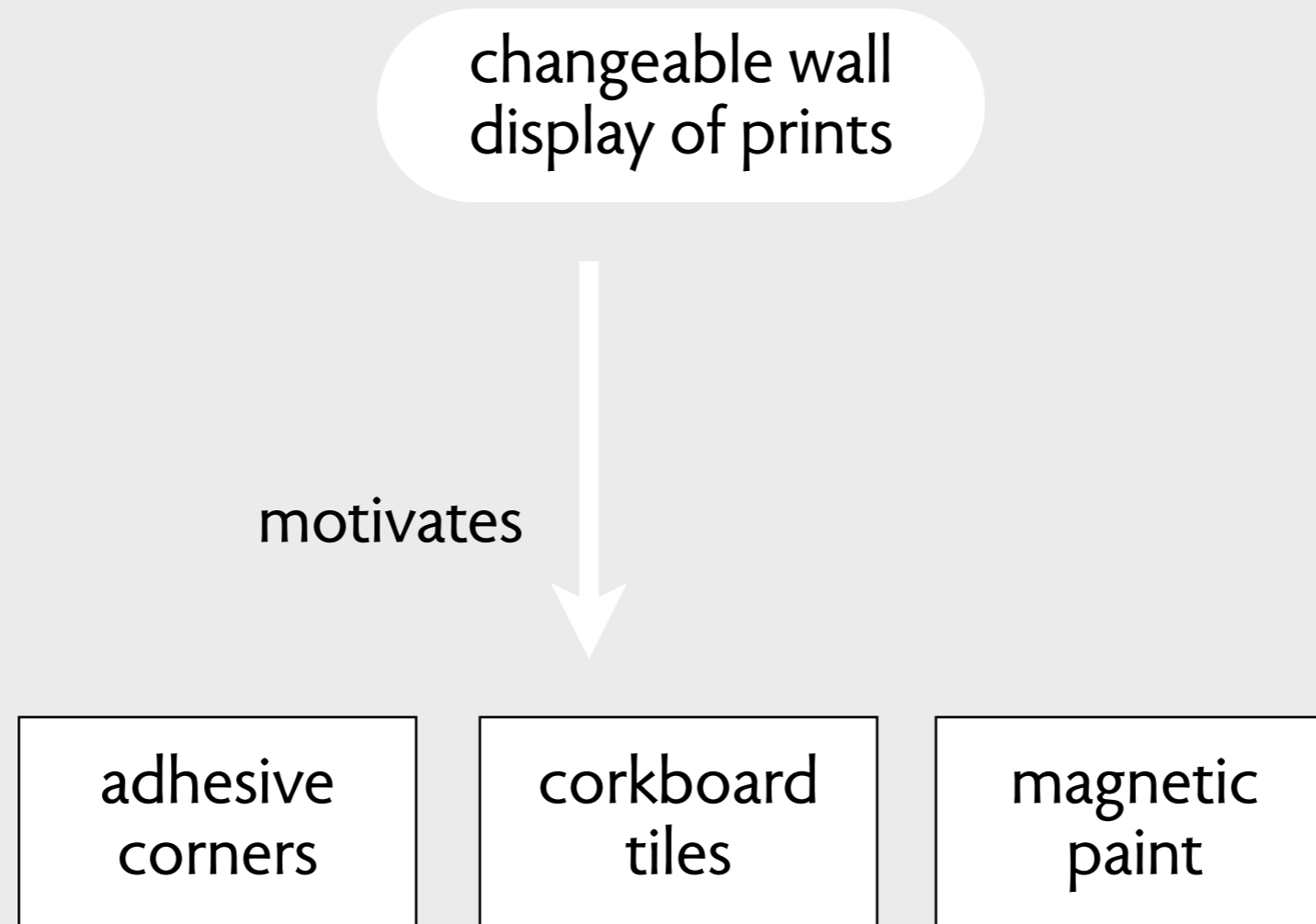

example: a photo wall

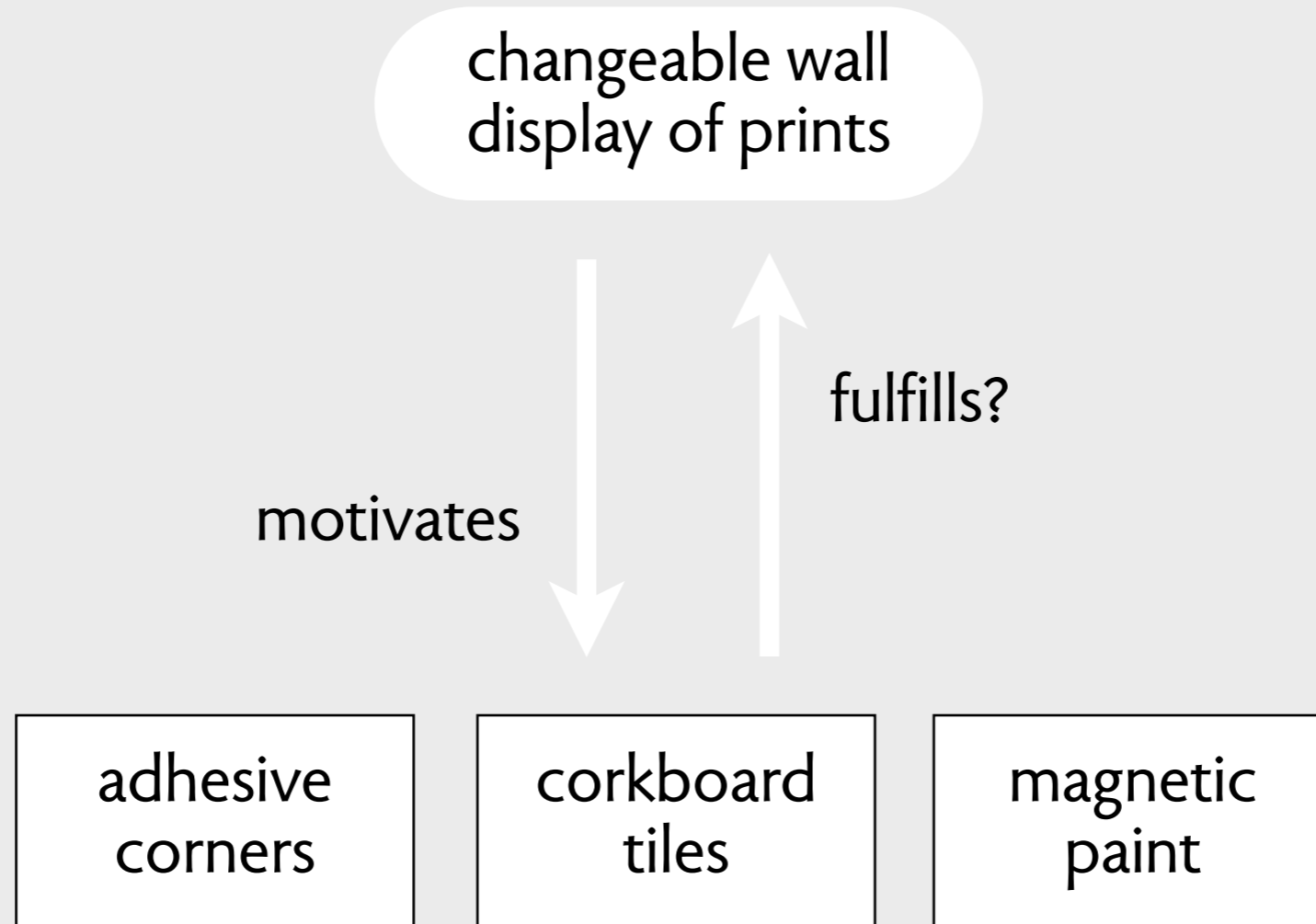

example: a photo wall

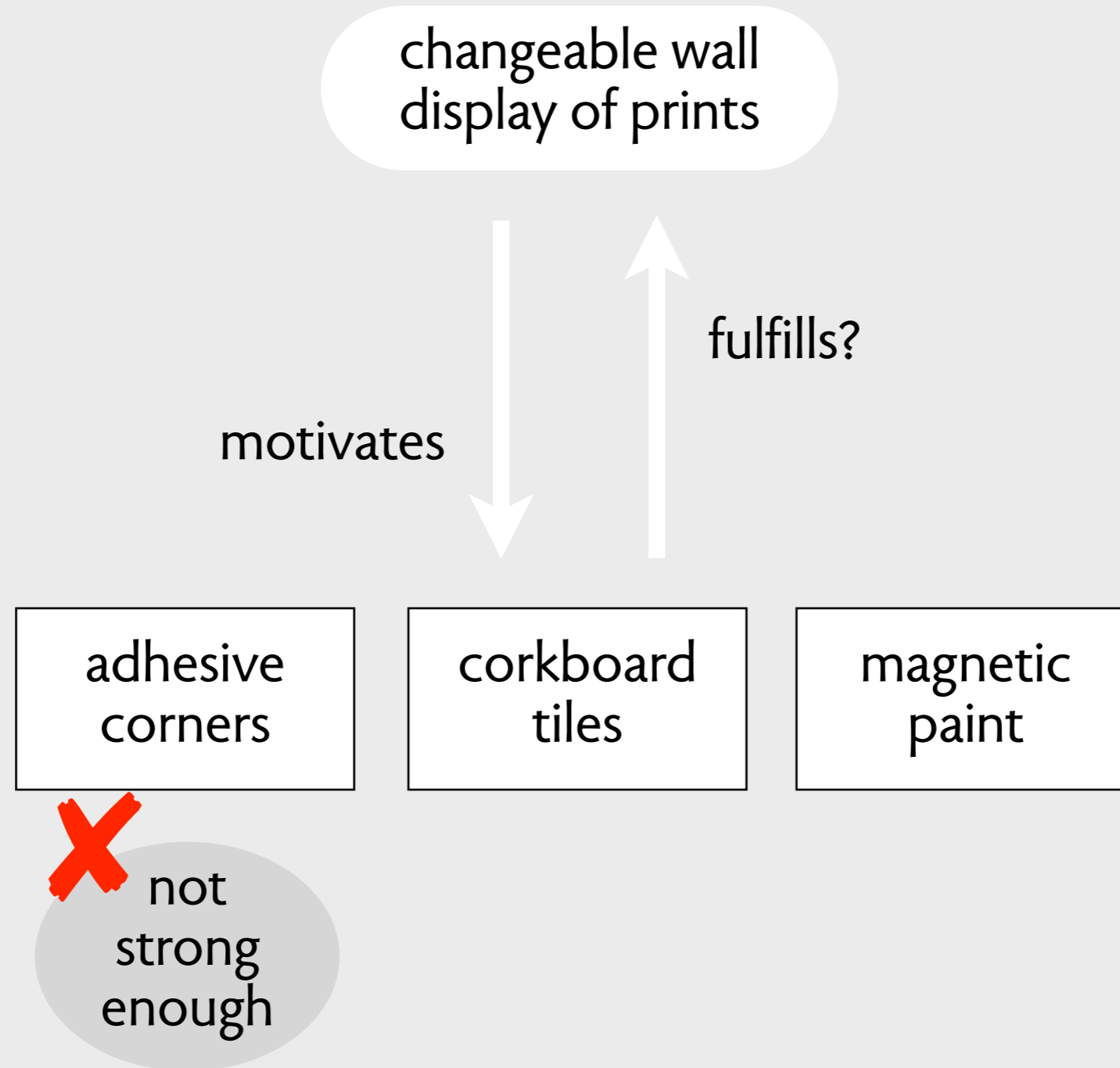

example: a photo wall

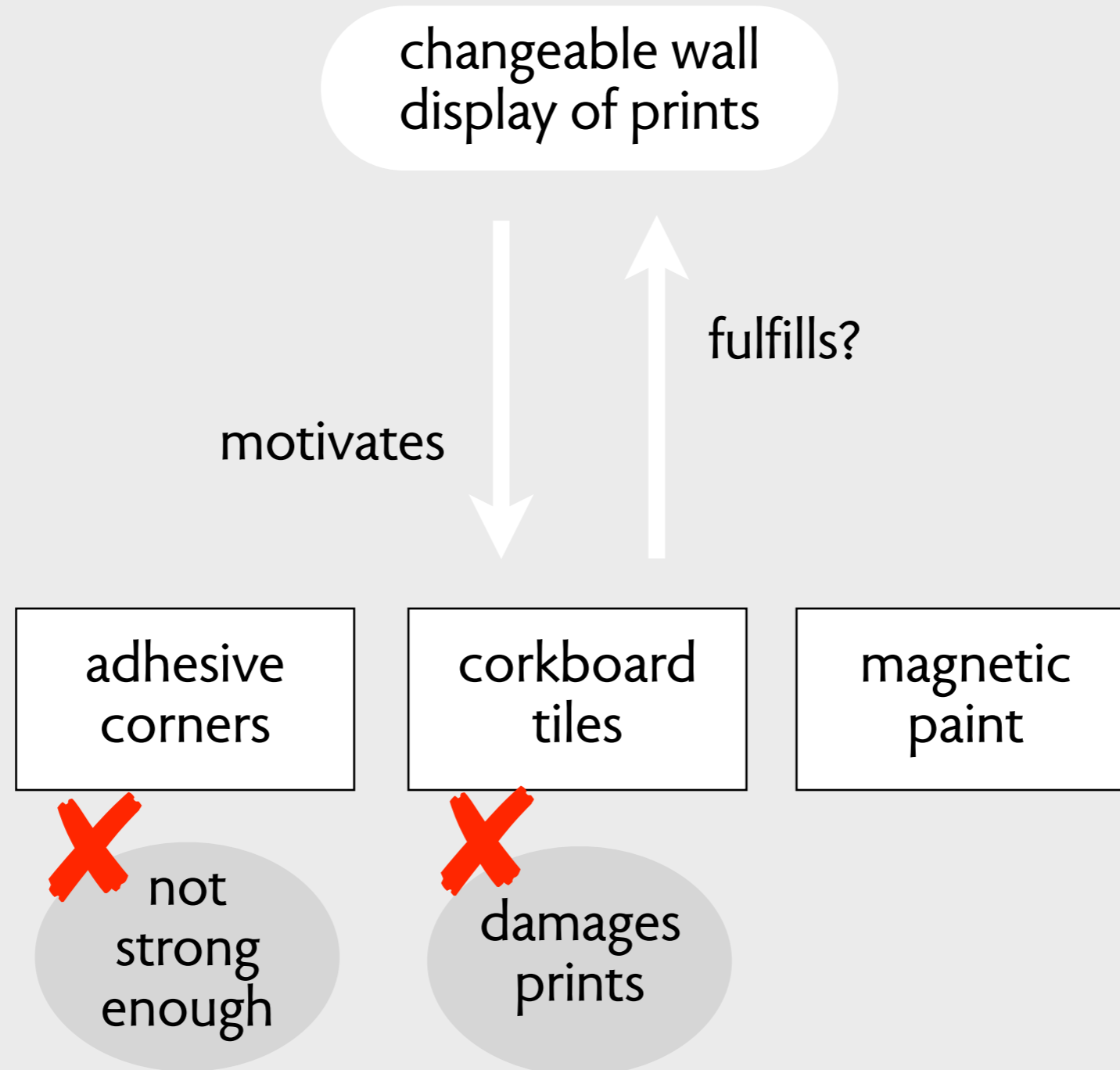

example: a photo wall

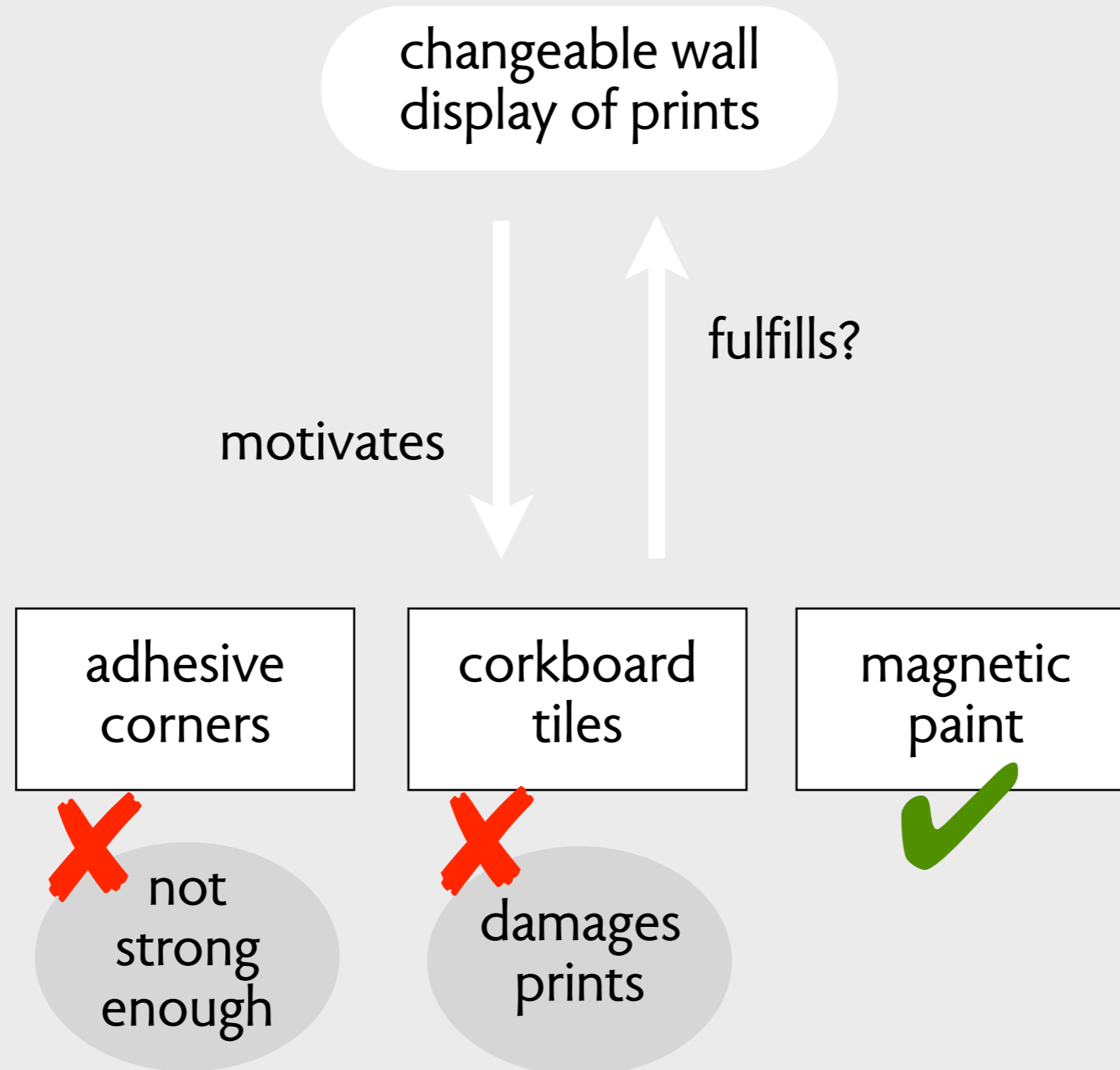

as implemented



refining the purpose with misfits

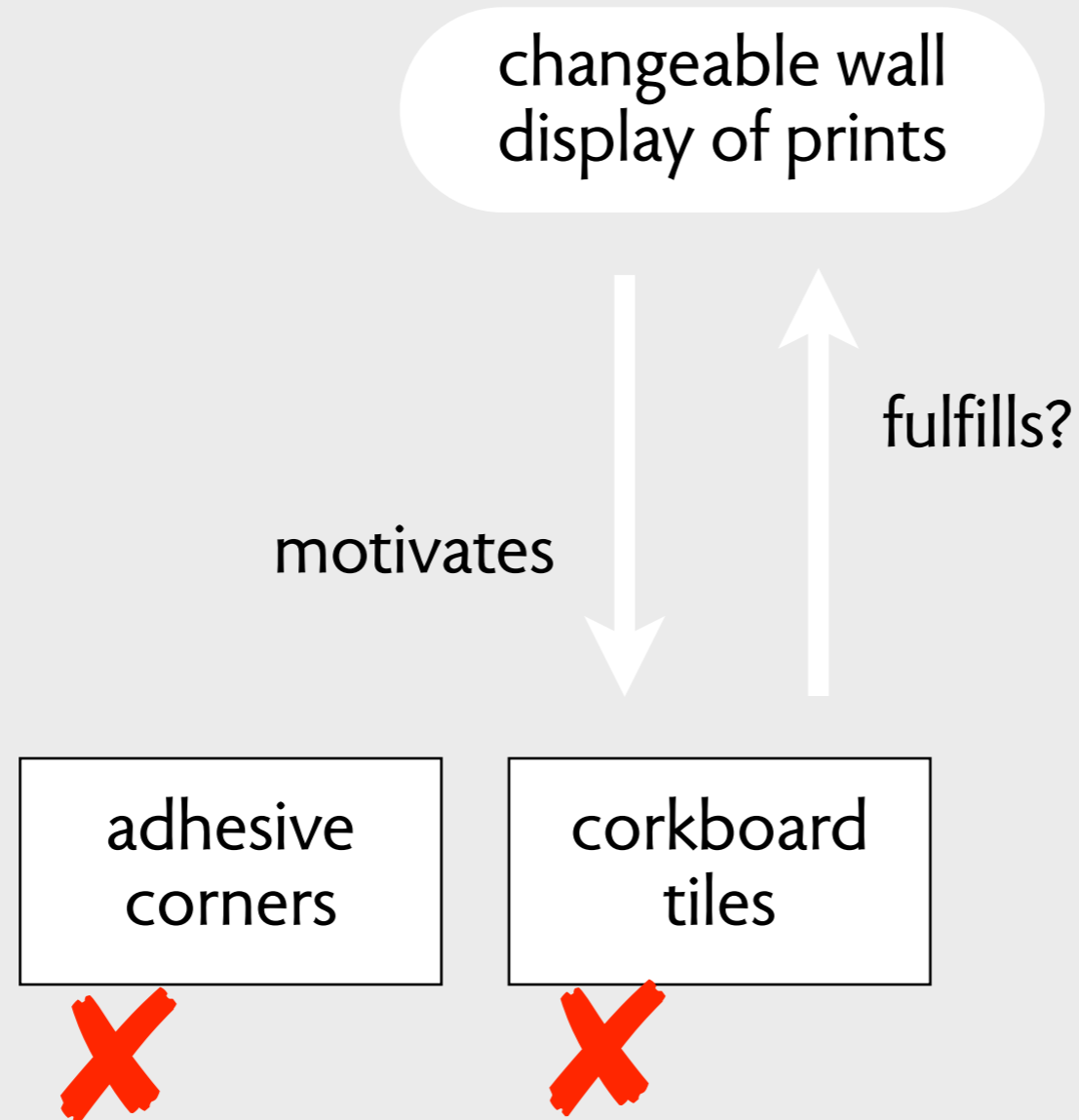

refining the purpose with misfits

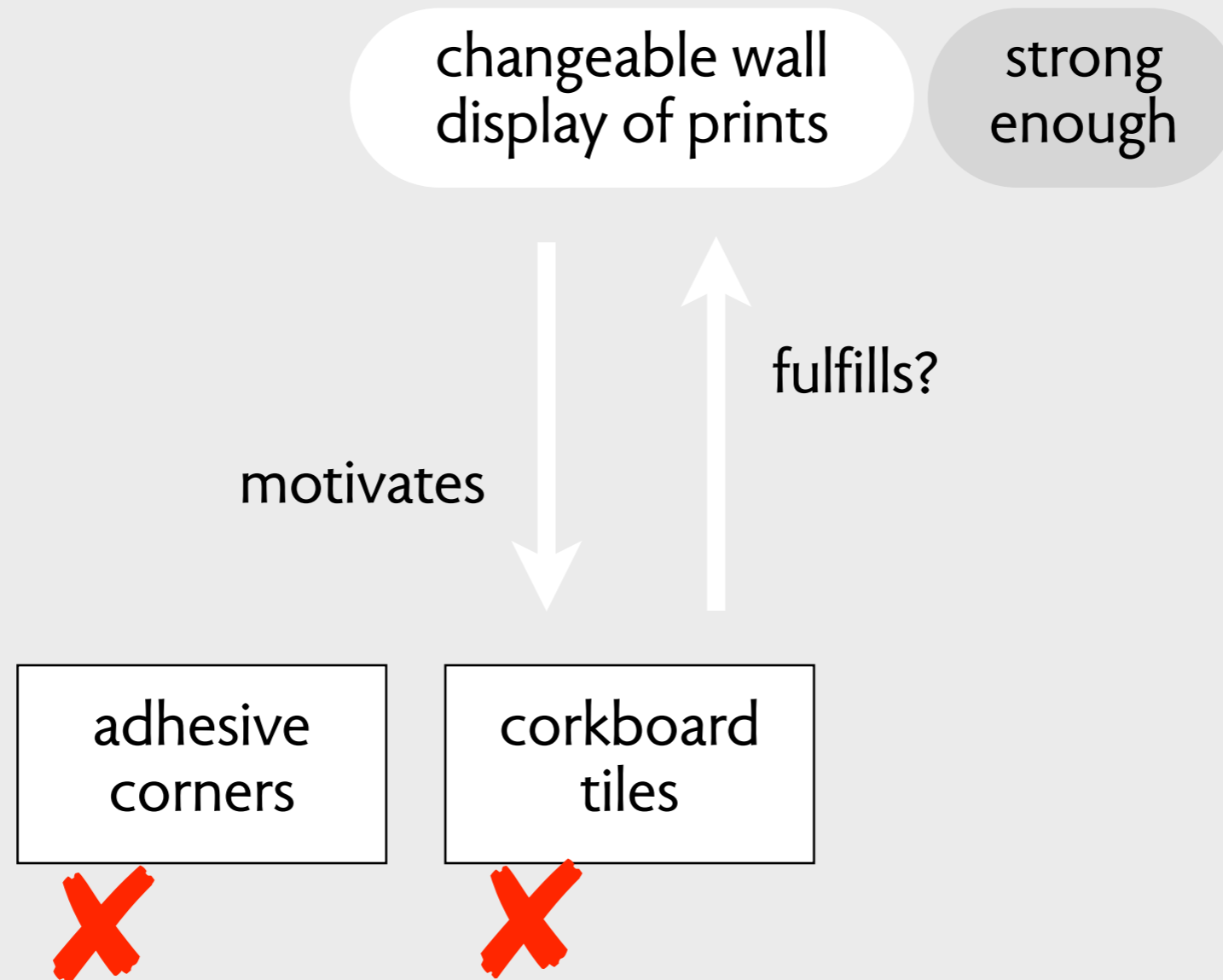

refining the purpose with misfits

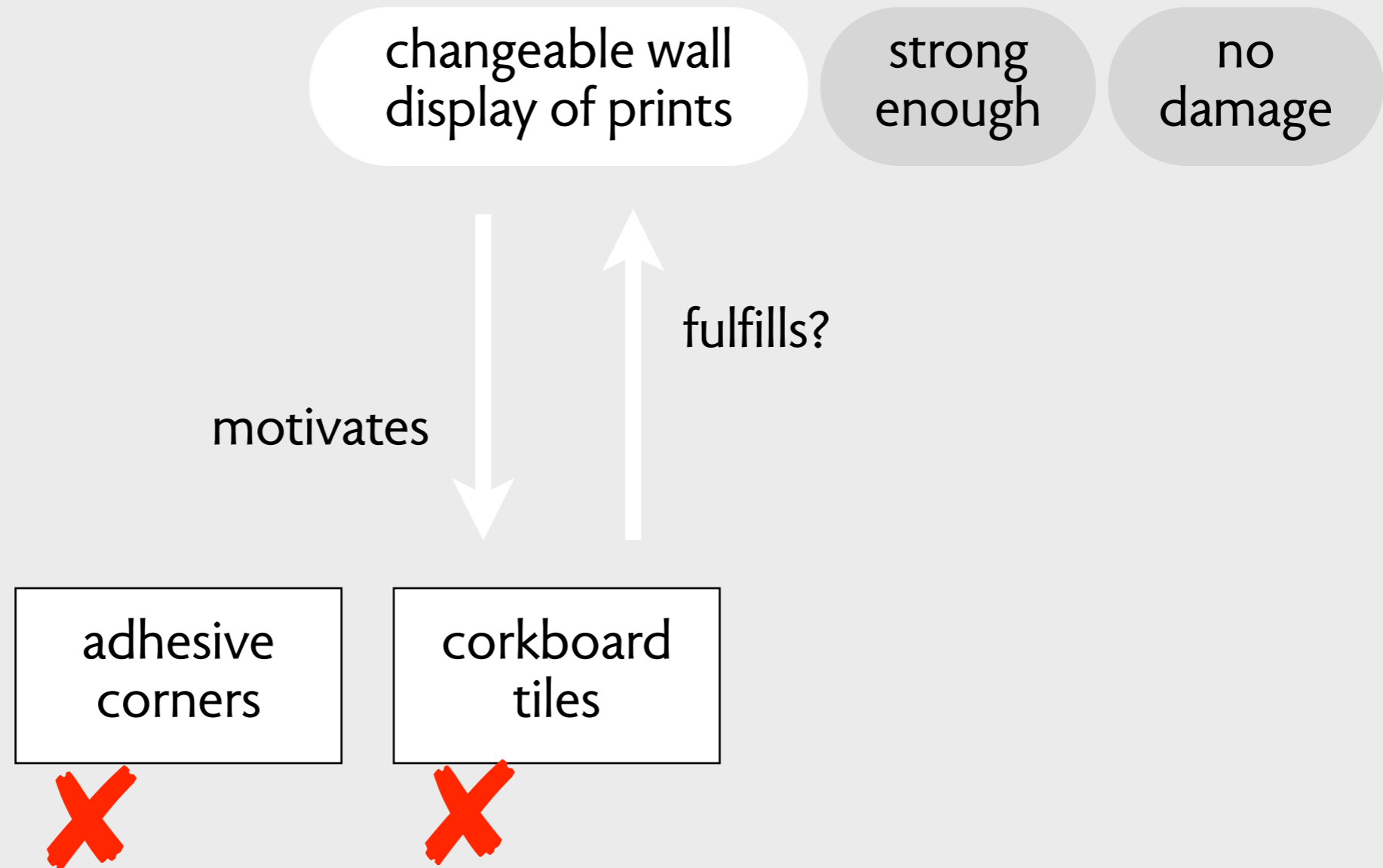

refining the purpose with misfits

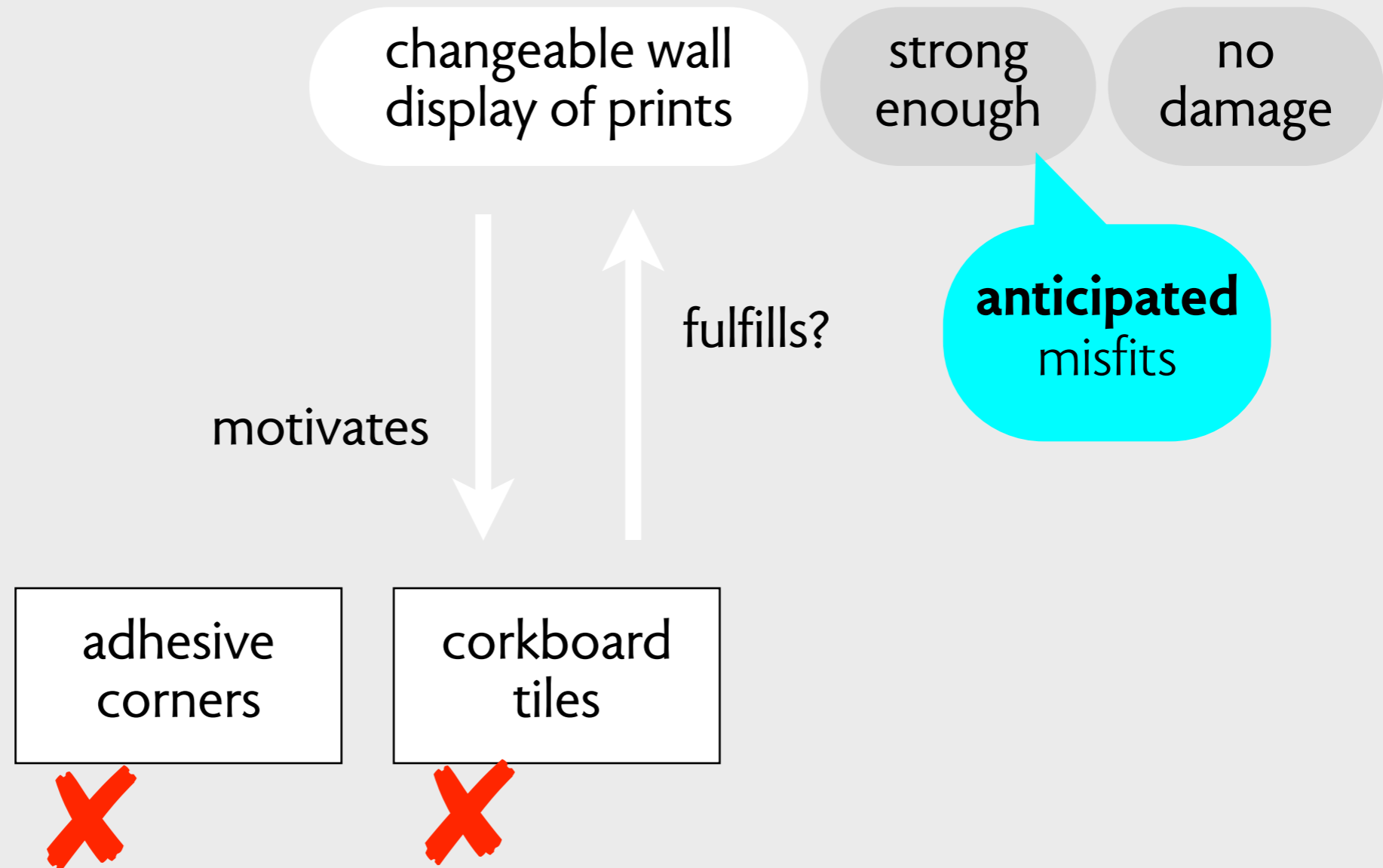

refining the purpose with misfits

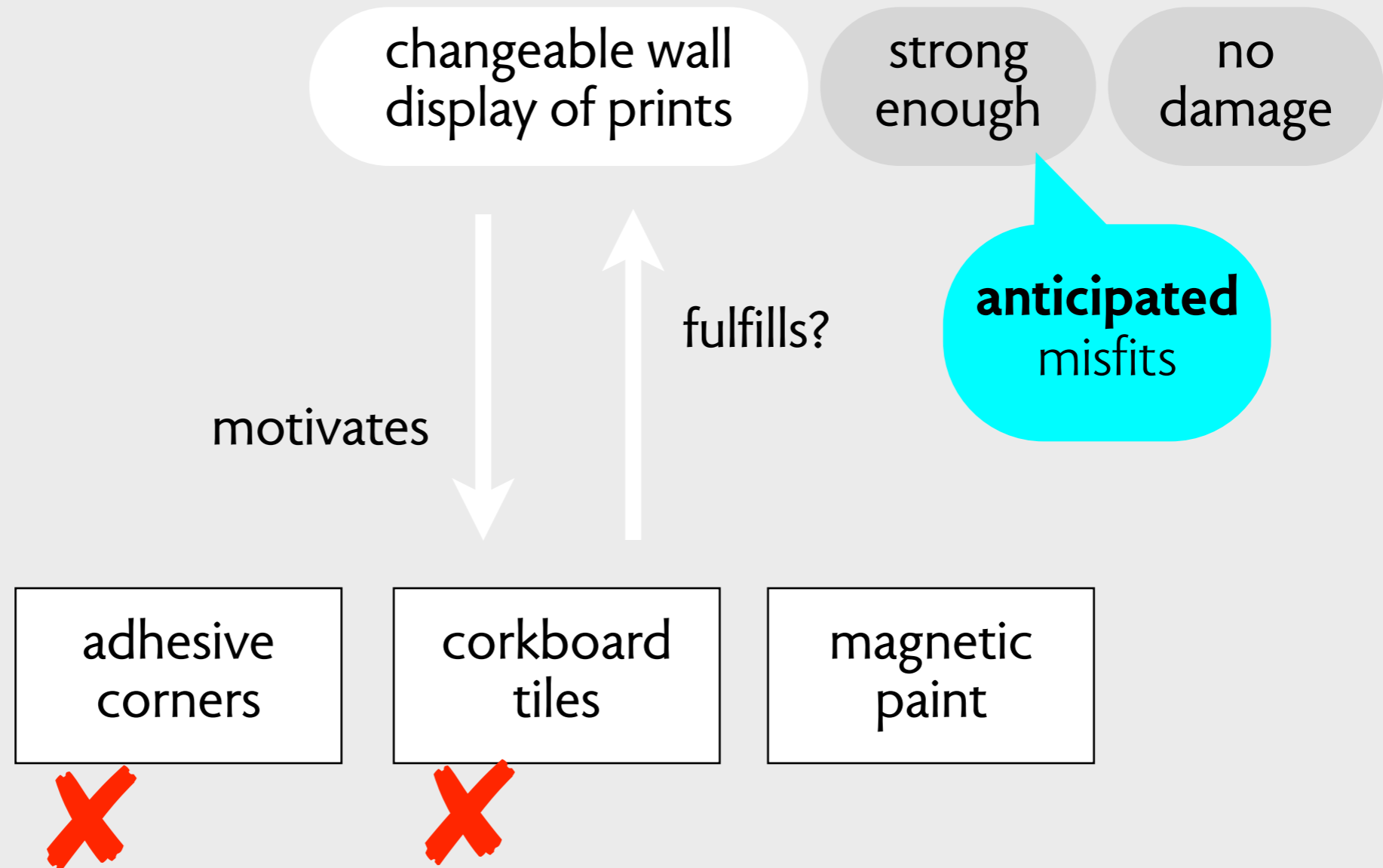

refining the purpose with misfits

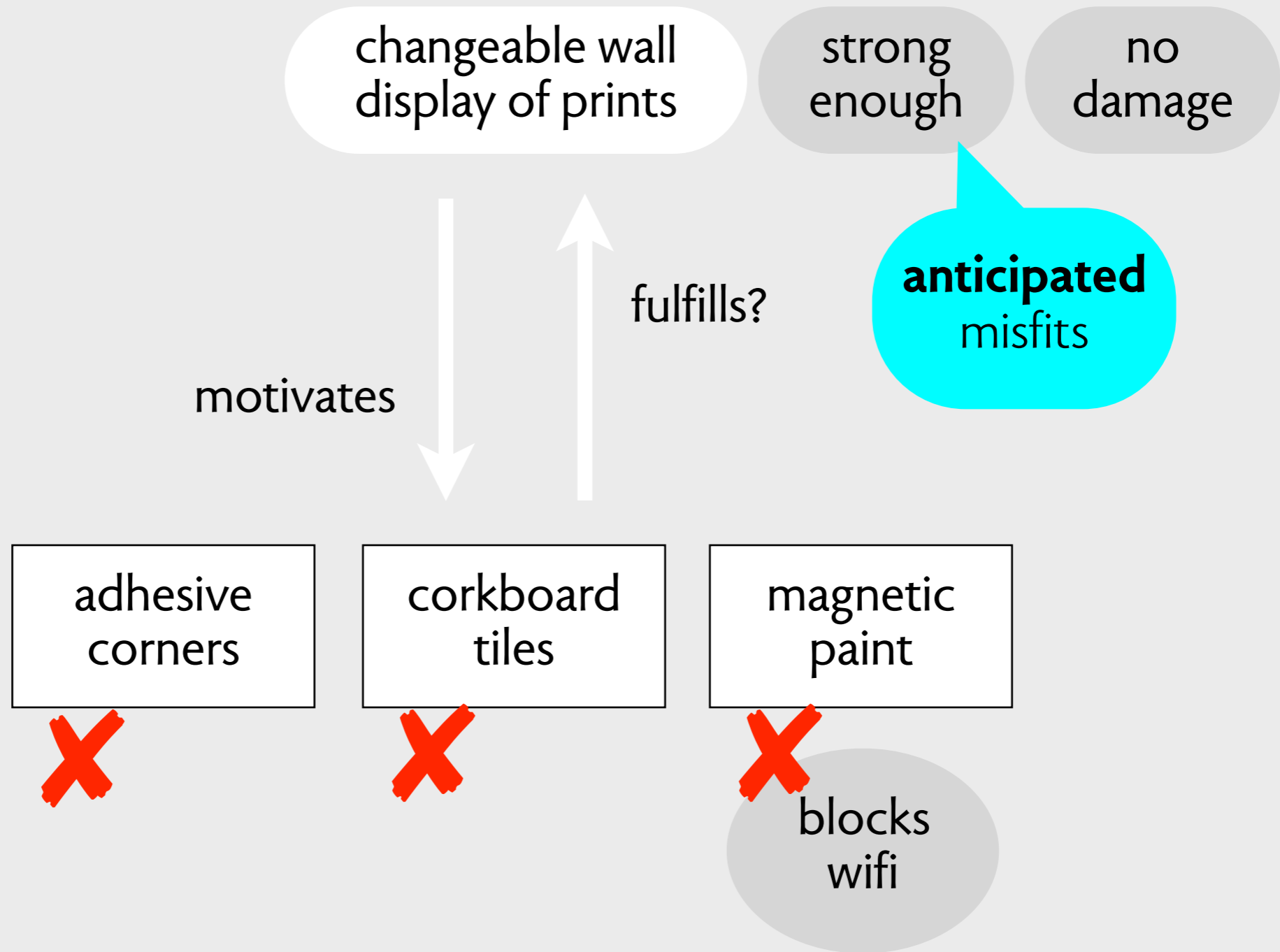

refining the purpose with misfits

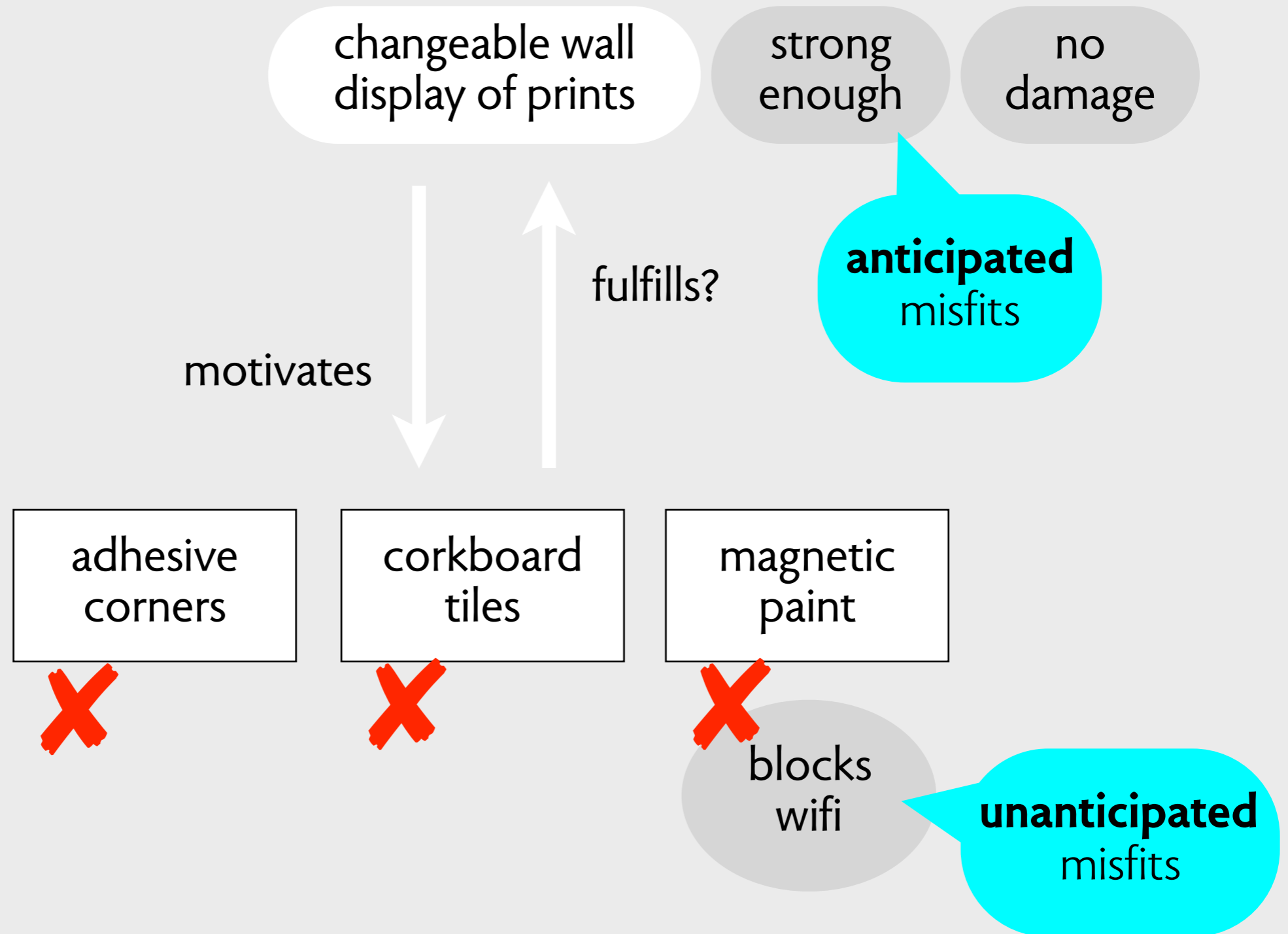

Copyright Material

NOTES ON THE SYNTHESIS OF FORM

CHRISTOPHER ALEXANDER

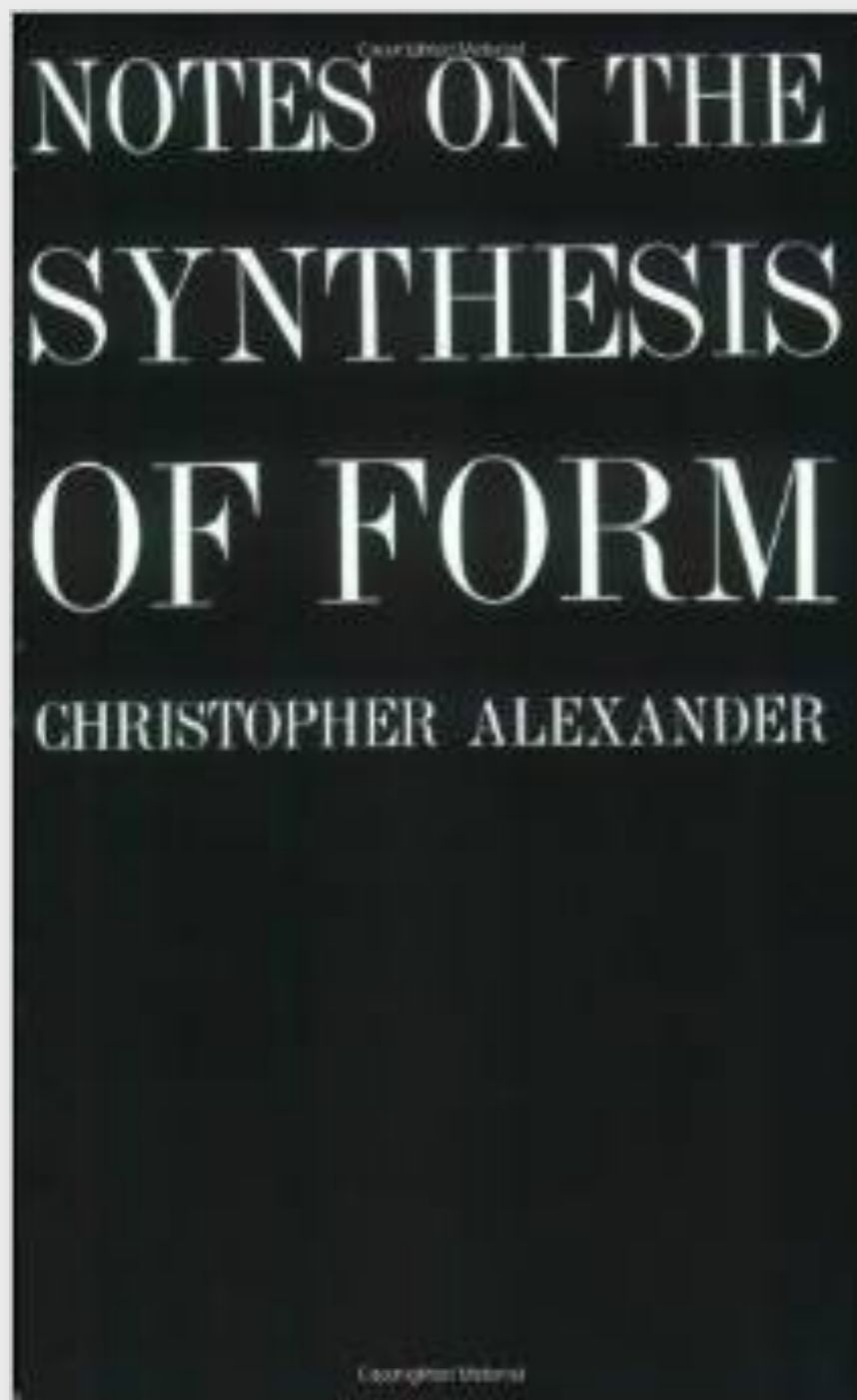

Such a list of requirements is potentially endless... But if we think of the requirements from a negative point of view, as potential misfits, there is a simple way of picking a finite set.

concepts driven by purposes too

application purpose

application

concepts driven by purposes too

application purpose

concept

application

concepts driven by purposes too

application purpose

concept

concept

application

concepts driven by purposes too

application purpose

concept

concept

concept

application

concepts driven by purposes too

application purpose

purpose

concept

concept

concept

application

concepts driven by purposes too

application purpose

purpose

purpose

concept

concept

concept

application

concepts driven by purposes too

application purpose

purpose

purpose

purpose

concept

concept

concept

application

concepts driven by purposes too

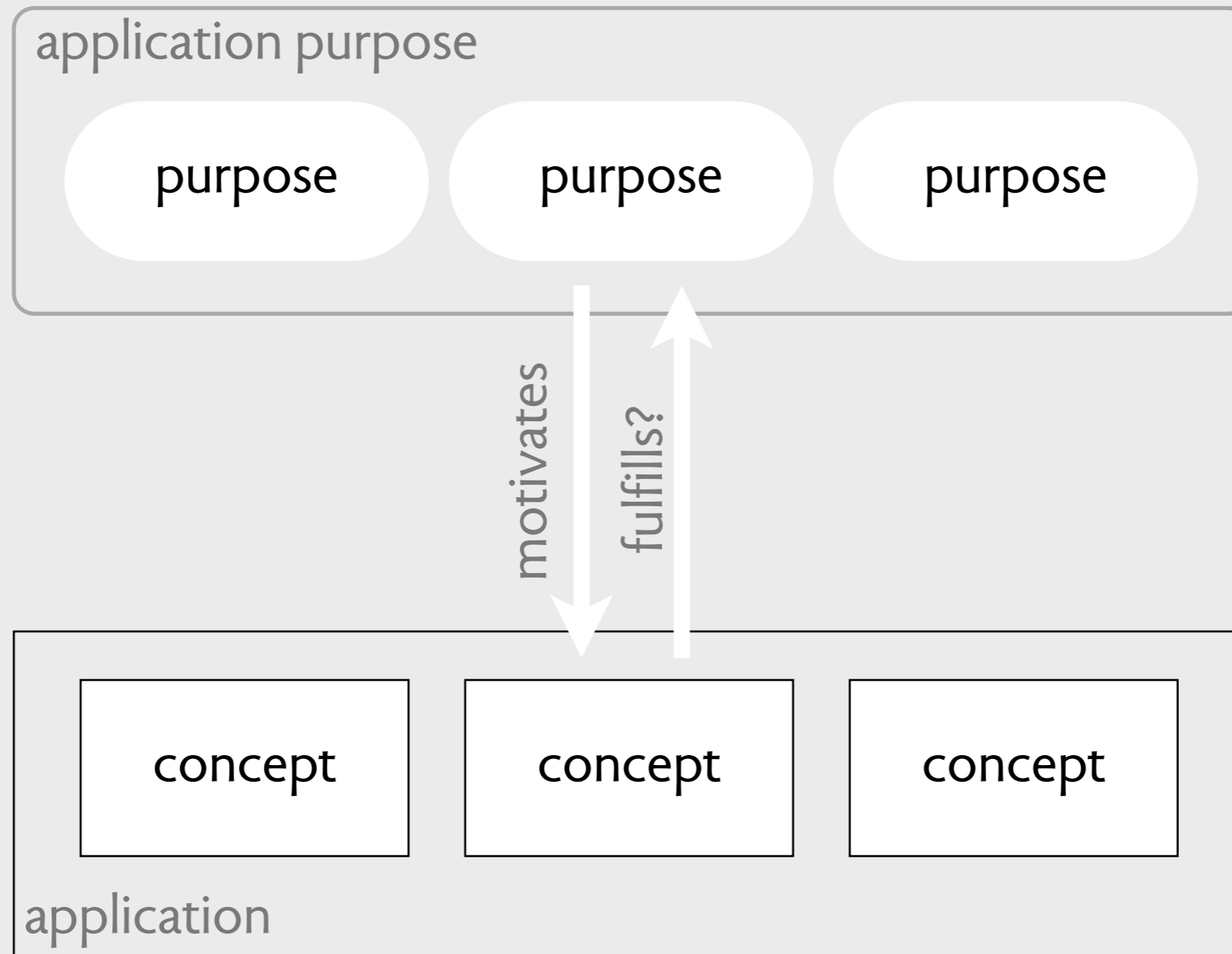

concepts driven by purposes too

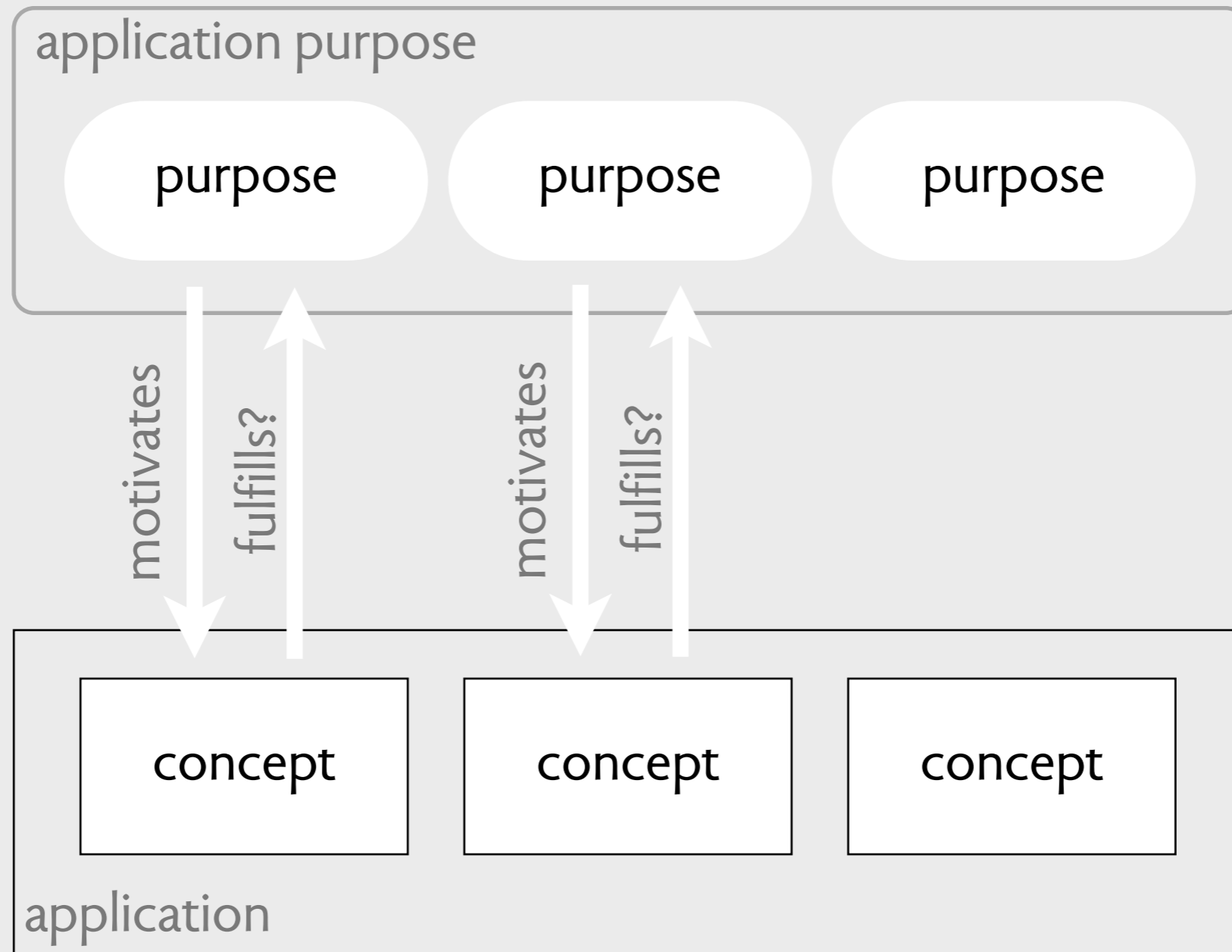

concepts driven by purposes too

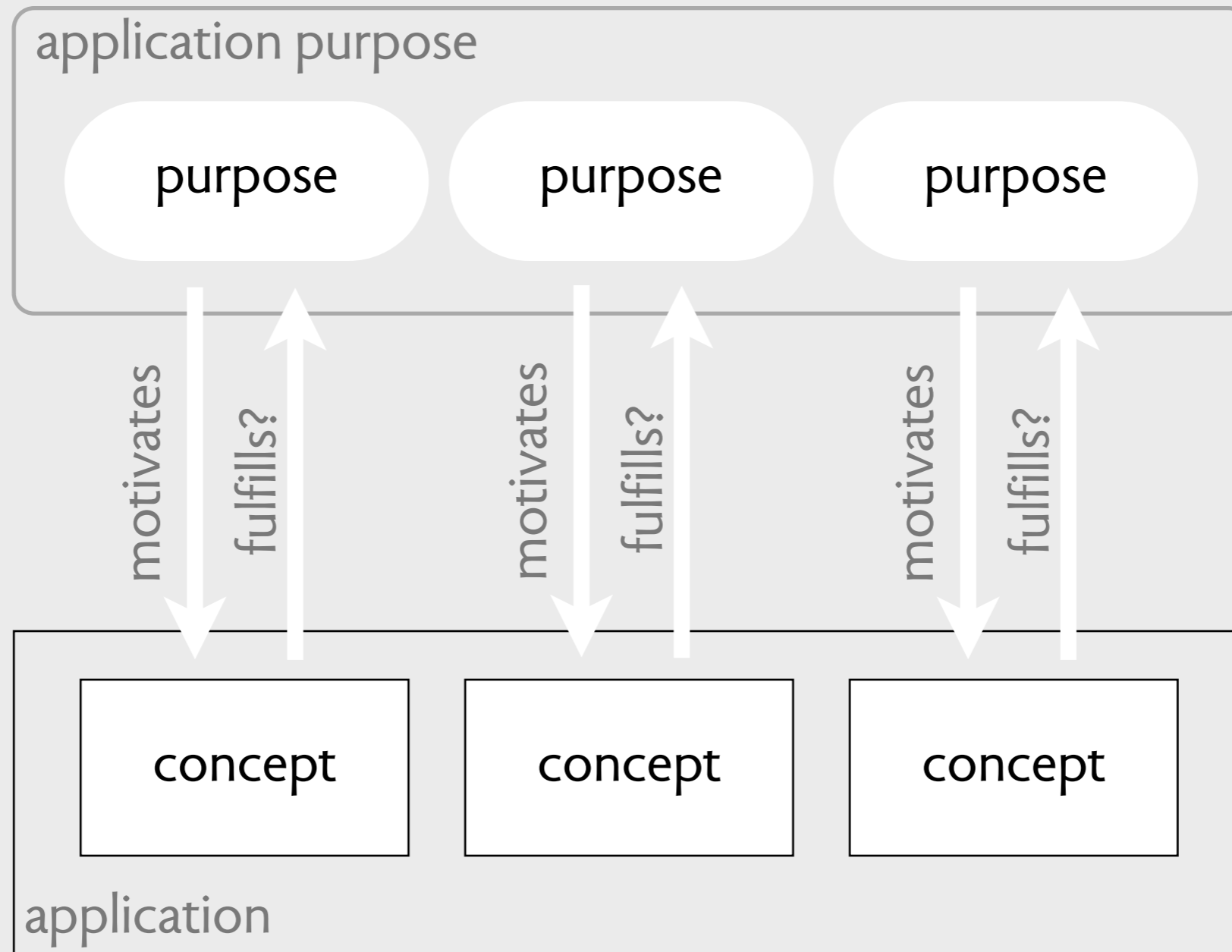

example: microsoft word

create & format documents

microsoft word

example: microsoft word

create & format documents

paragraph

microsoft word

example: microsoft word

create & format documents

style

paragraph

microsoft word

example: microsoft word

create & format documents

style

paragraph

stylesheet

microsoft word

example: microsoft word

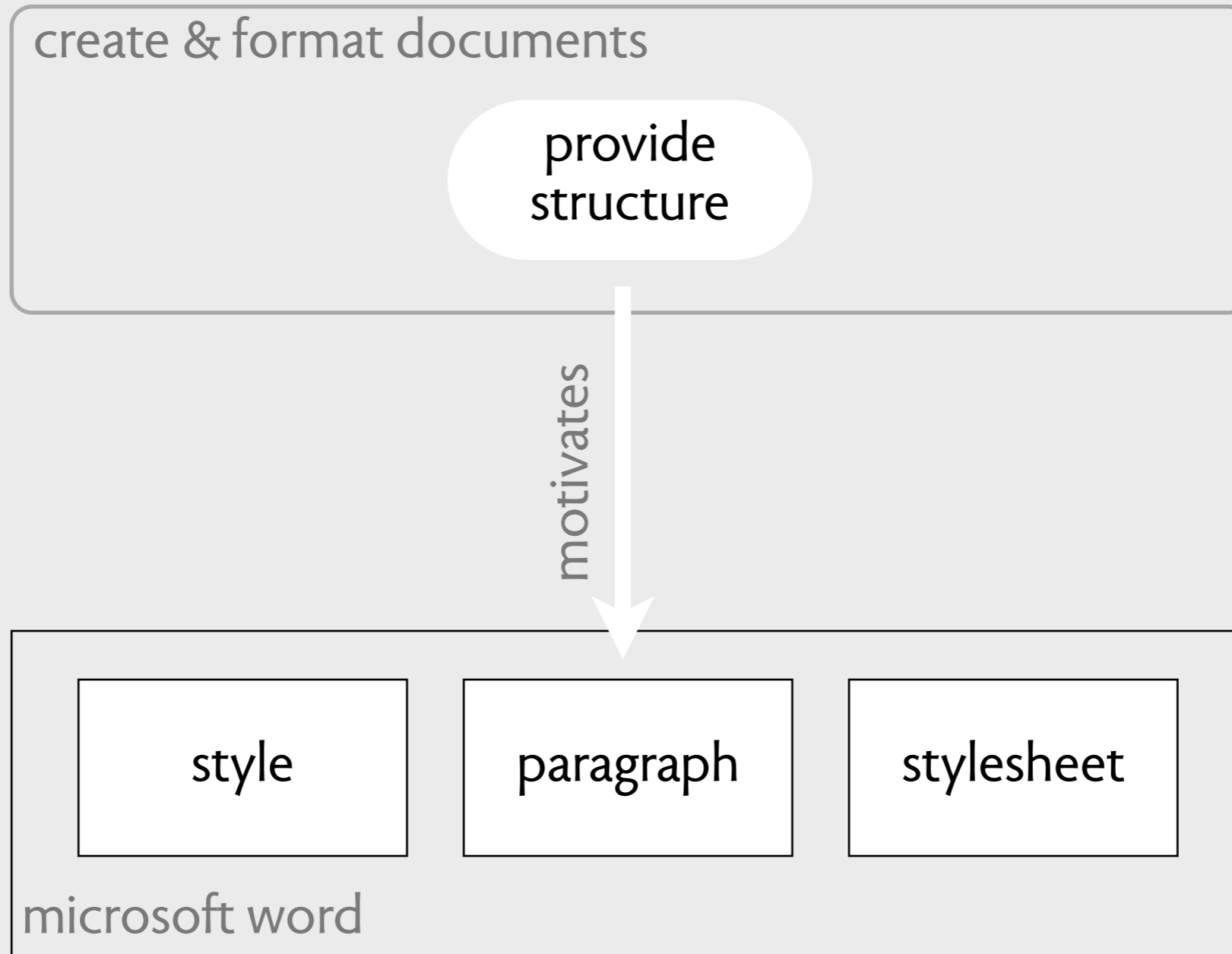

example: microsoft word

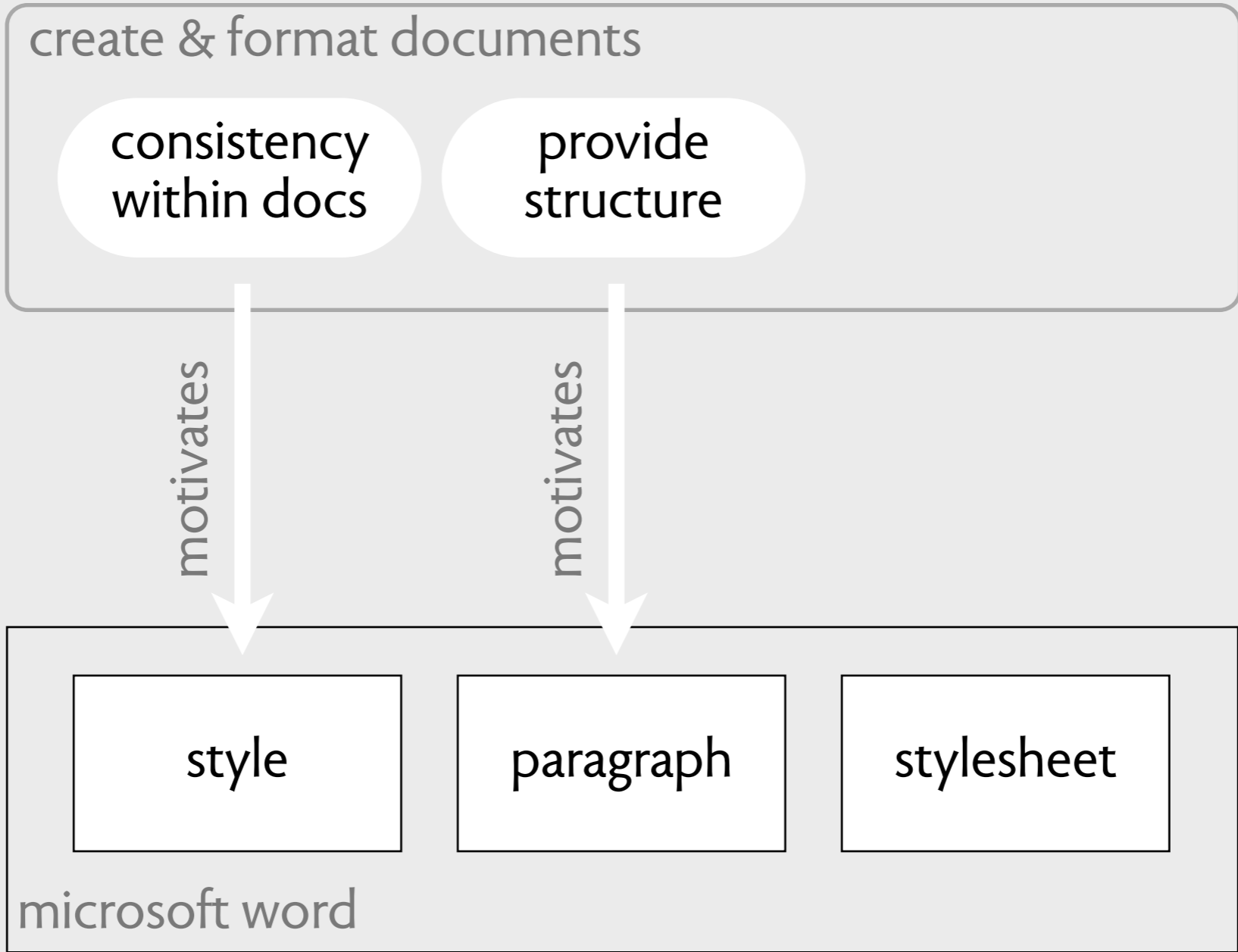

example: microsoft word

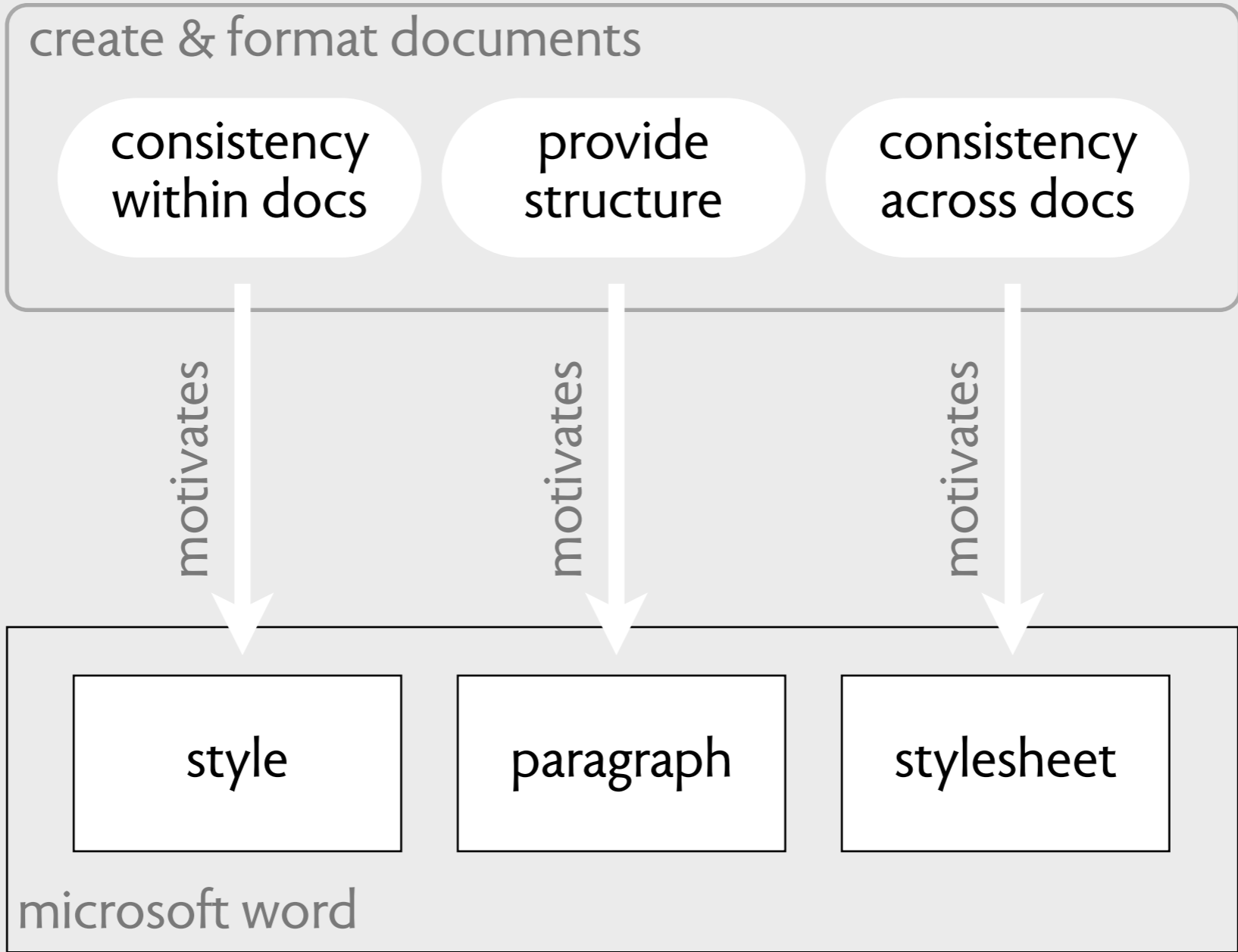

concepts
are machines

example word styles

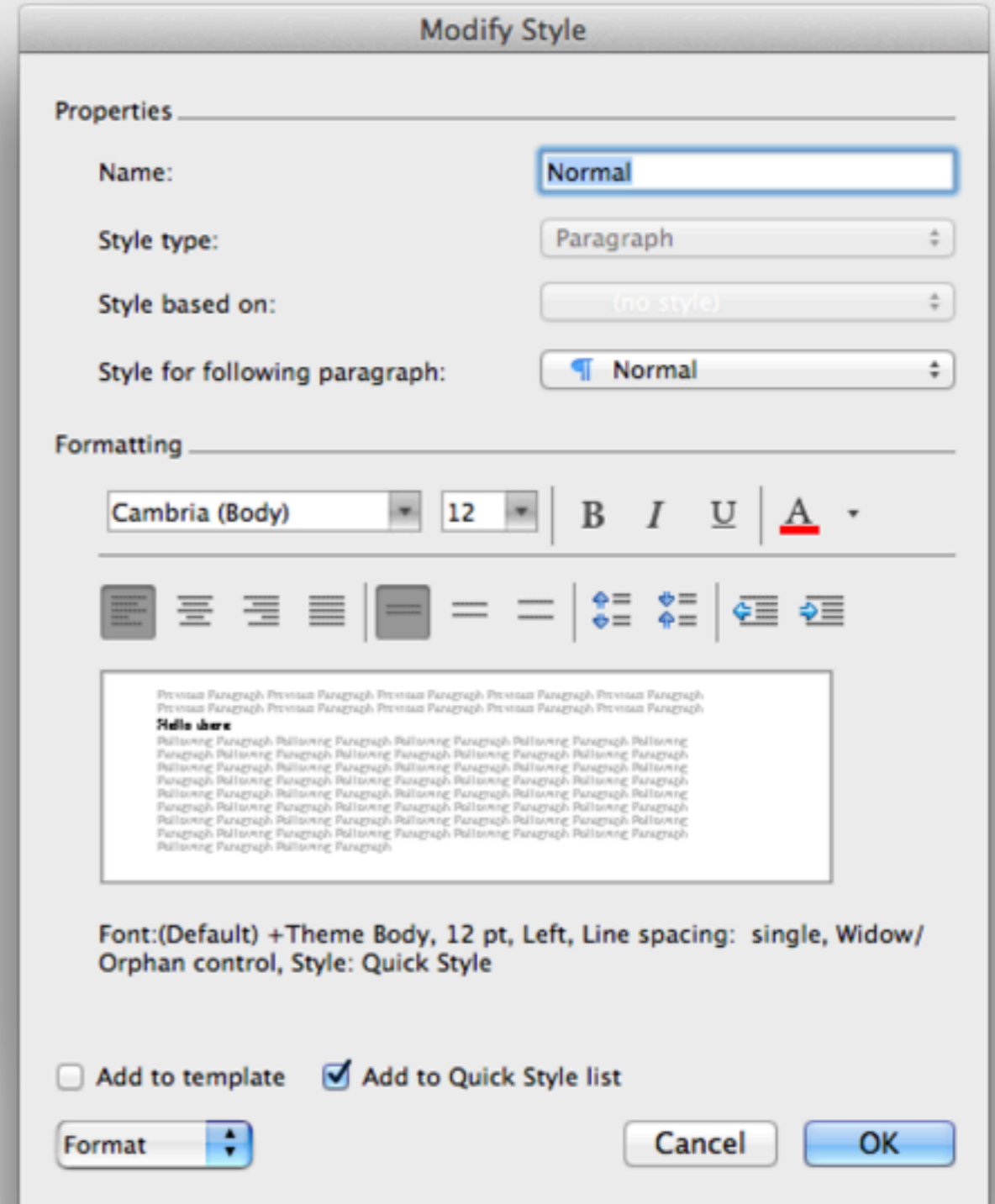
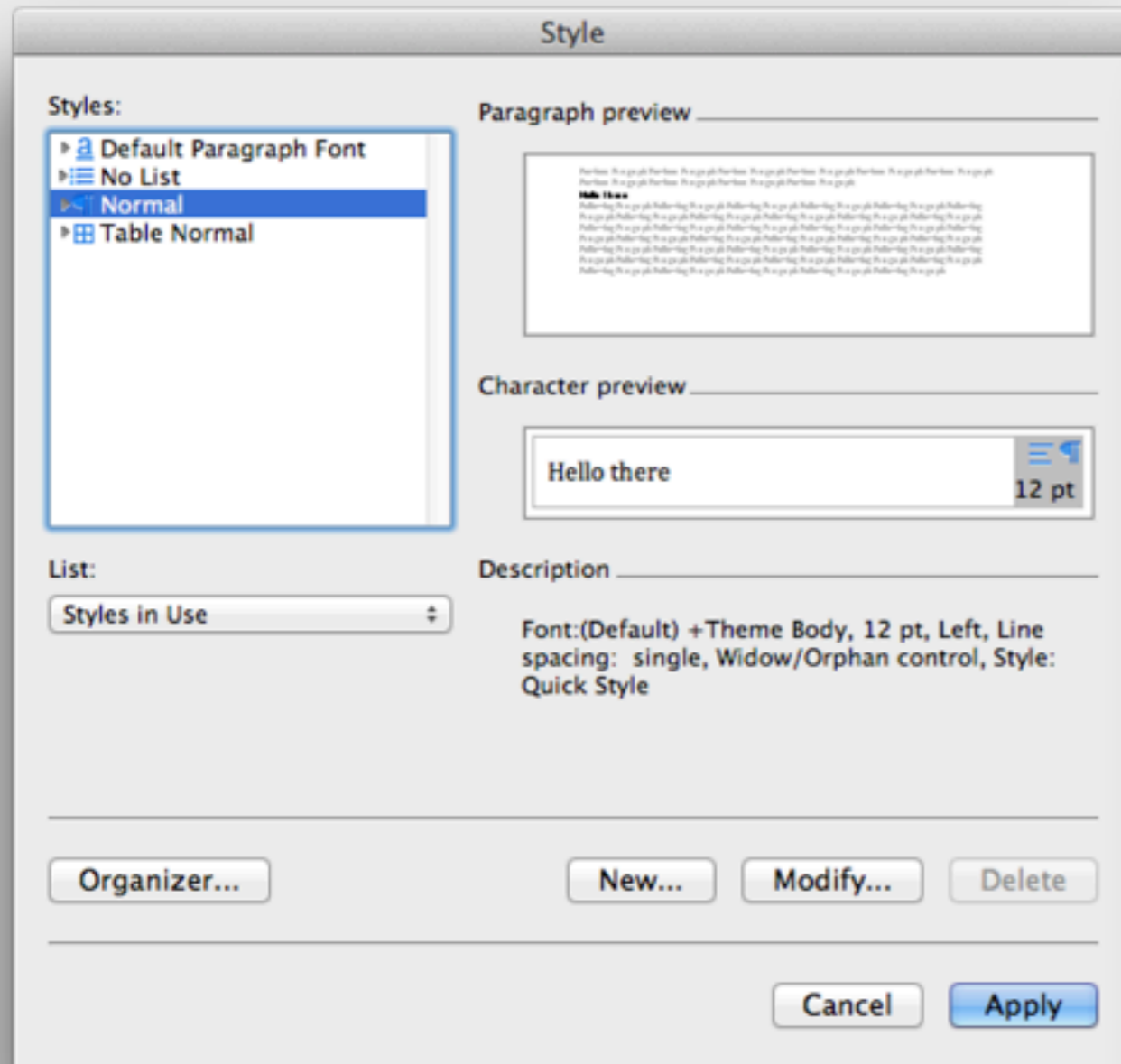

concept model word styles

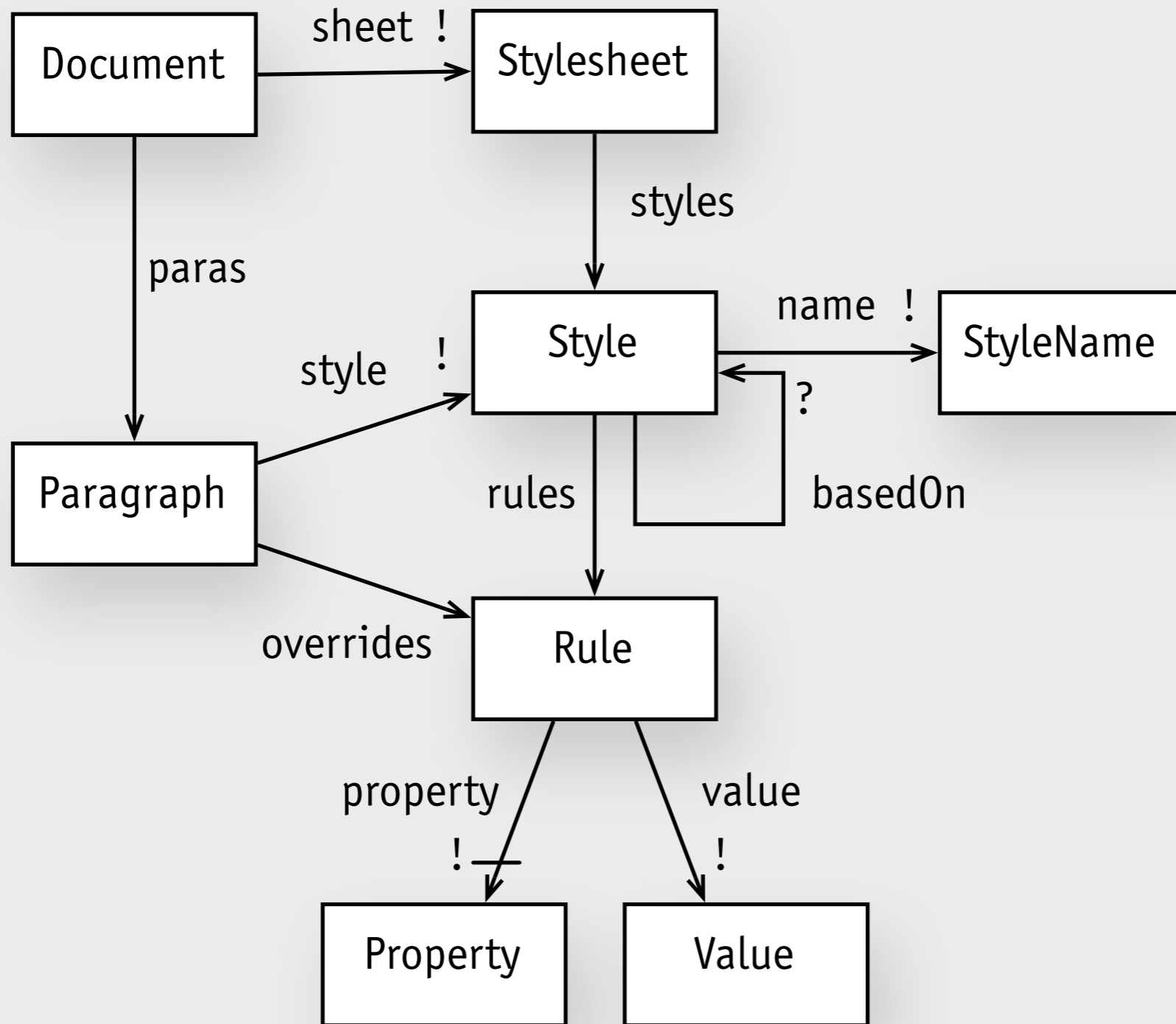

concept model word styles

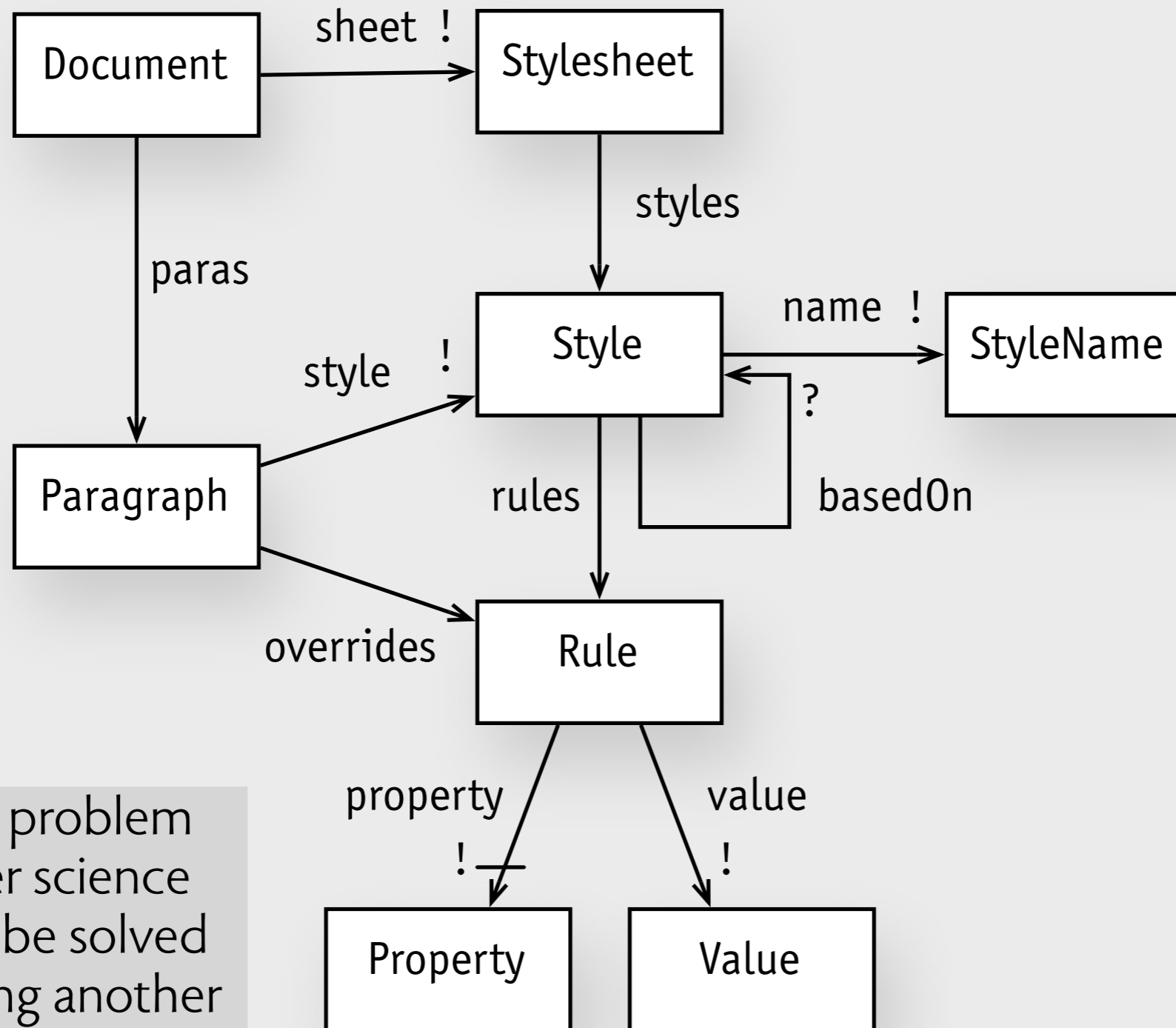

There is no problem
in computer science
that cannot be solved
by introducing another
level of indirection.
David Wheeler

concept model word styles

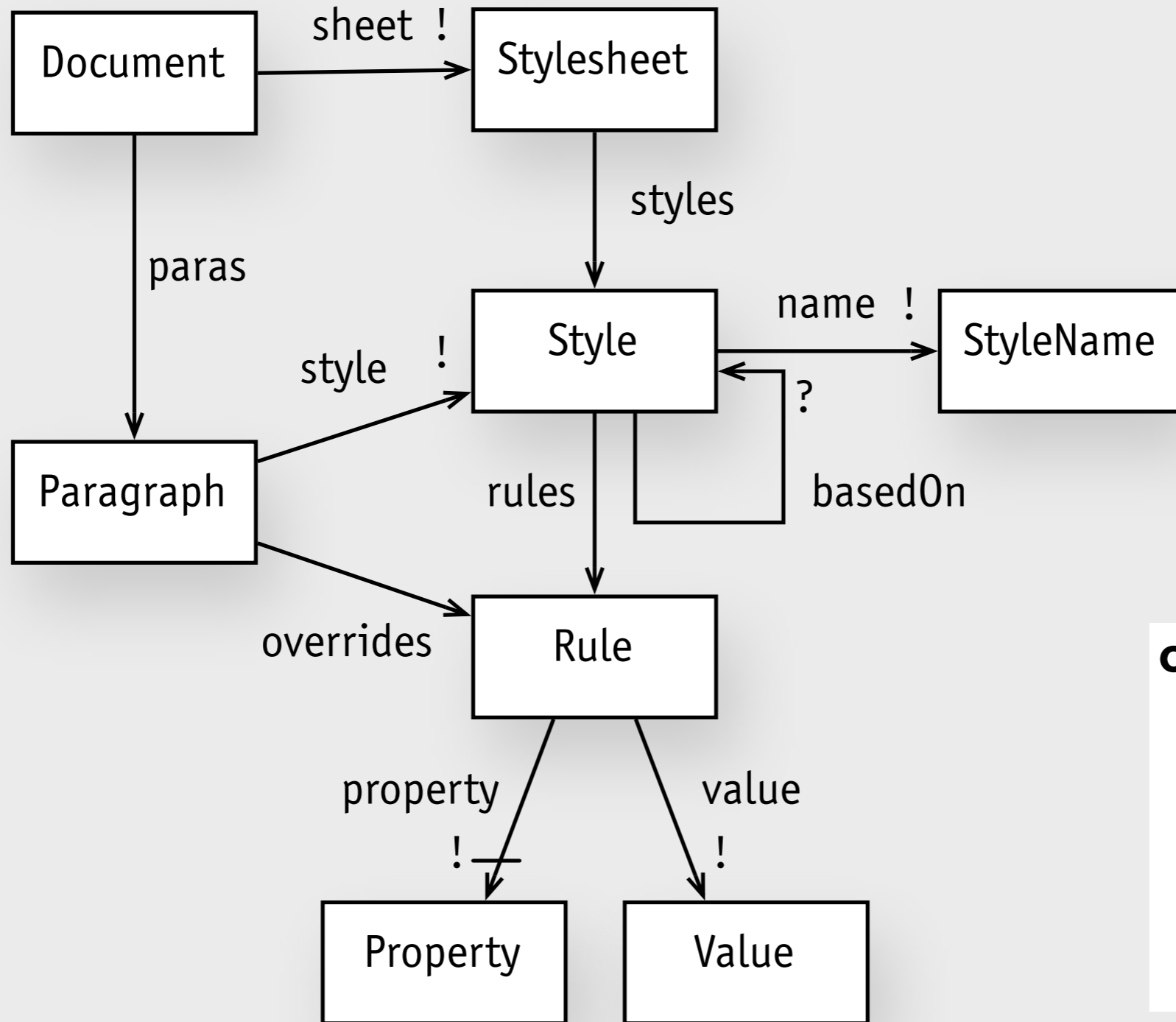

operations

add
delete
modify
update
apply

concept characteristics

concept characteristics

concepts are closed
state & all relevant operations

concept characteristics

concepts are closed

state & all relevant operations

concepts are situated

not awaiting composition

so a concept is not ...

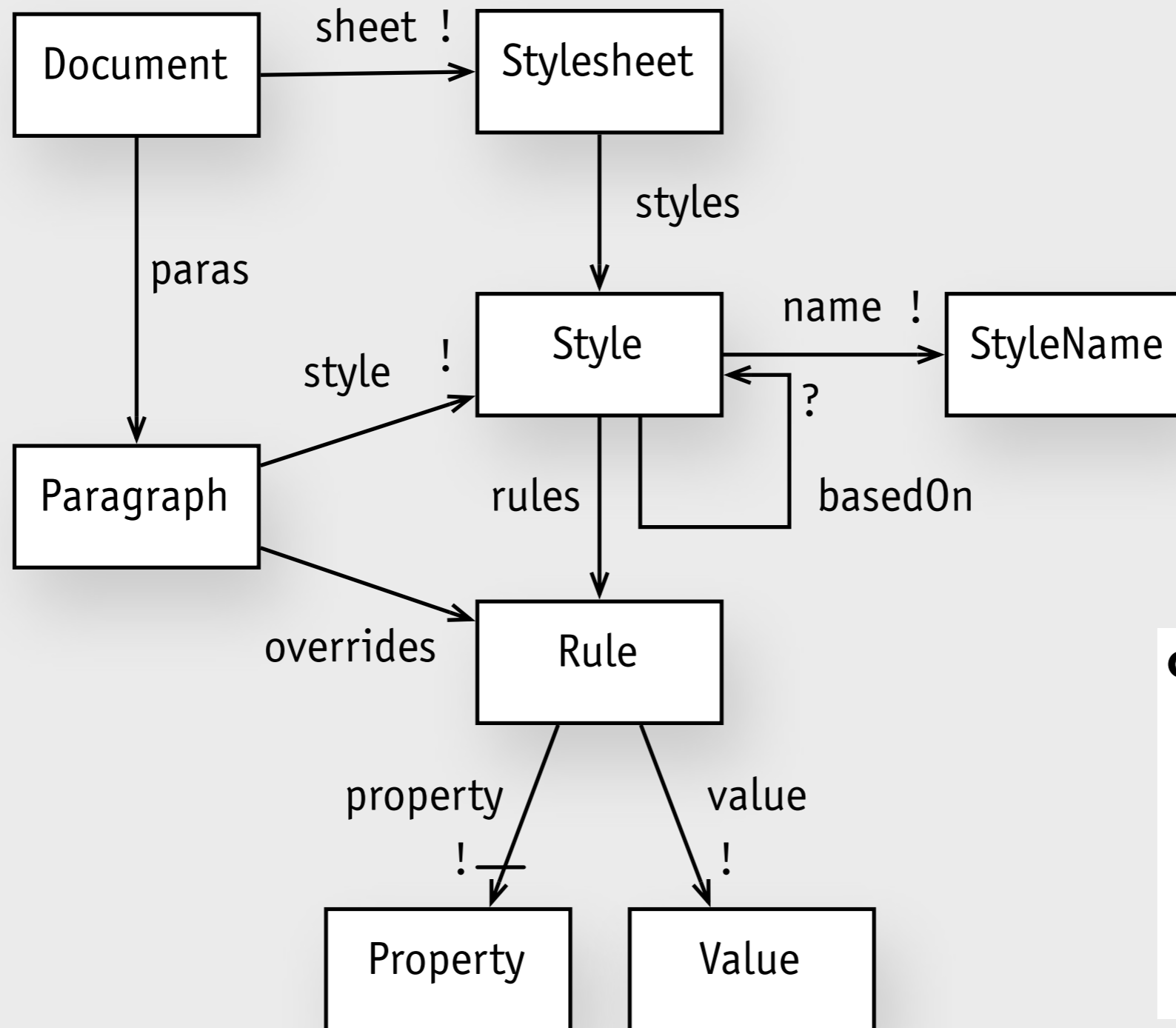

operations

add
delete
modify
update
apply

so a concept is not ...

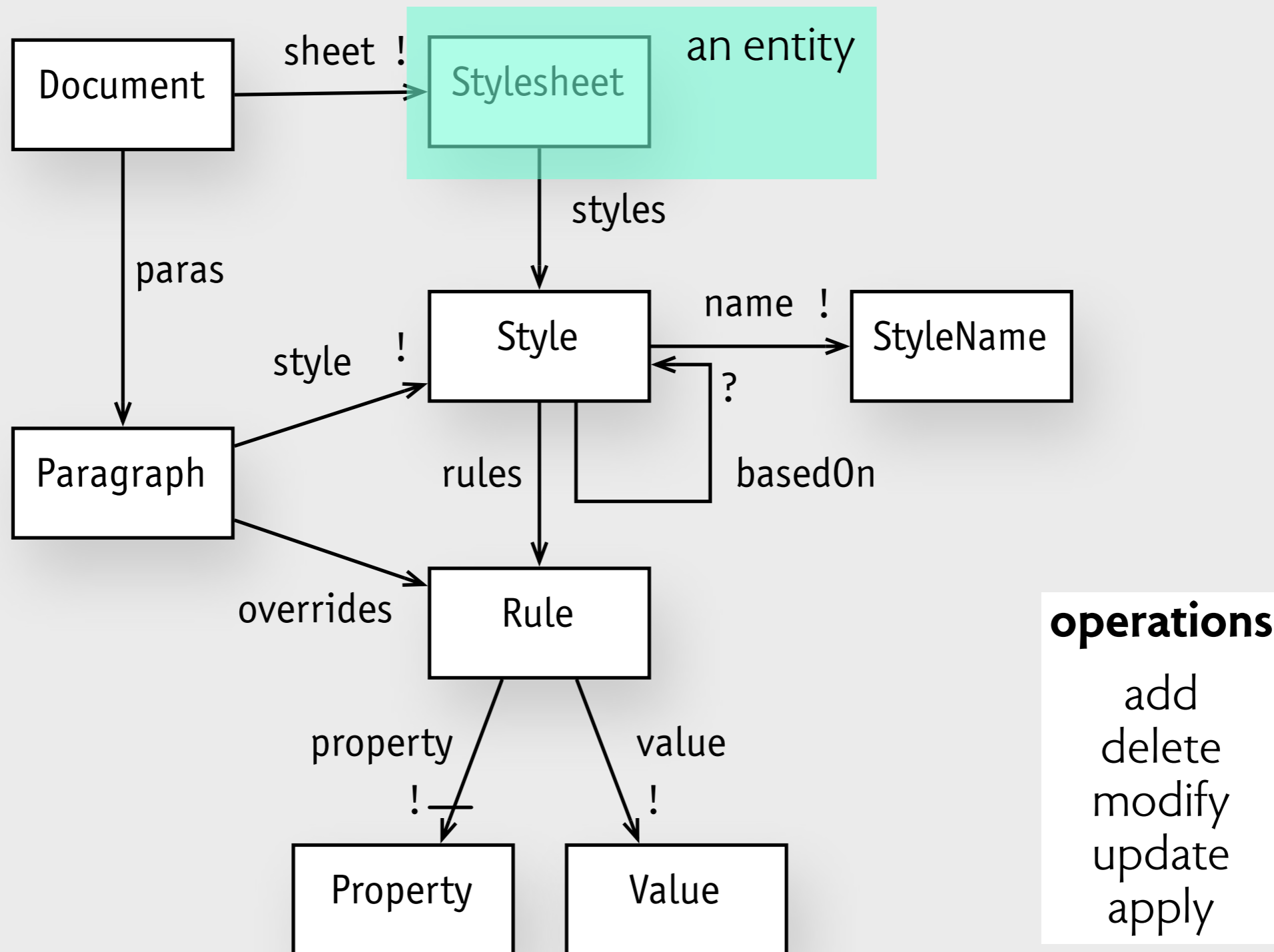

so a concept is not ...

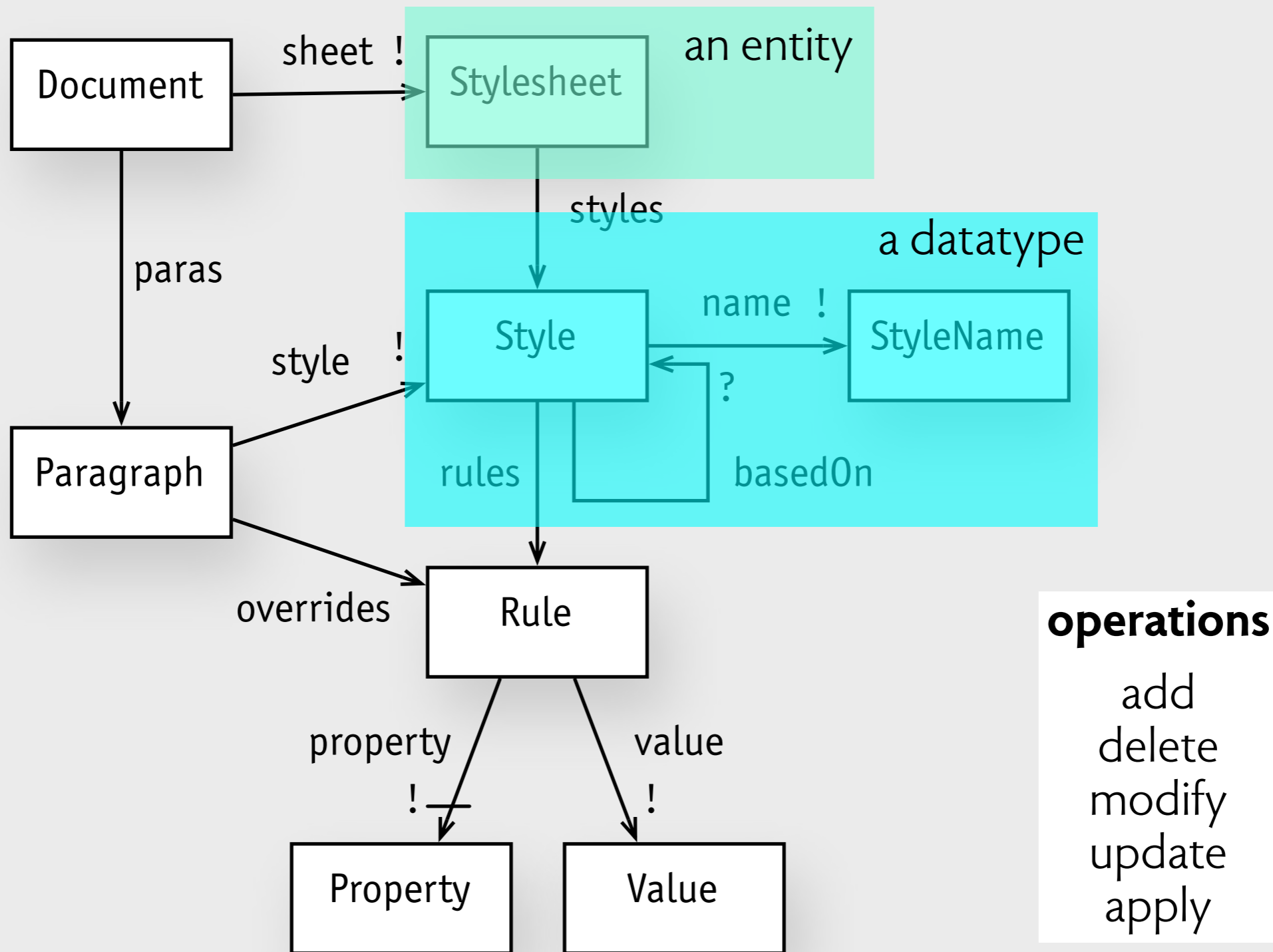

so a concept is not ...

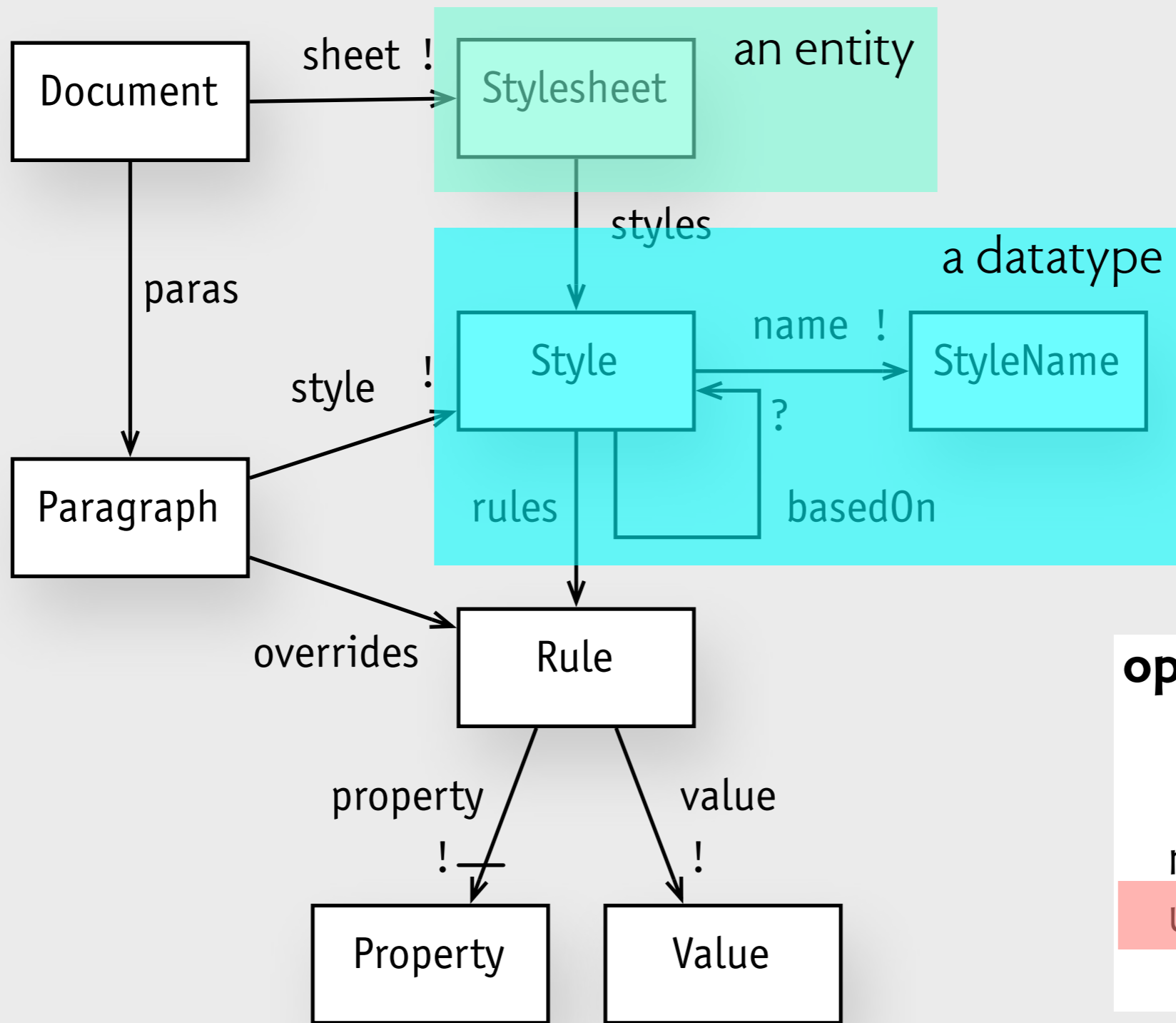

- operations**
- add
 - delete
 - modify
 - update
 - apply

a feature

OPs vs user stories

operational principle (vs user story)

operational principle (vs user story)

connects to purpose

so OP for trash must include restore

operational principle (vs user story)

connects to purpose

so OP for trash must include restore

has sufficient span

so OP for secure trash must go up to data recovery

operational principle (vs user story)

connects to purpose

so OP for trash must include restore

has sufficient span

so OP for secure trash must go up to data recovery

separates essential from accidental

so OP for trash doesn't say files disappear when eject disk

efficiency
in design

sharing: the essence of good design?

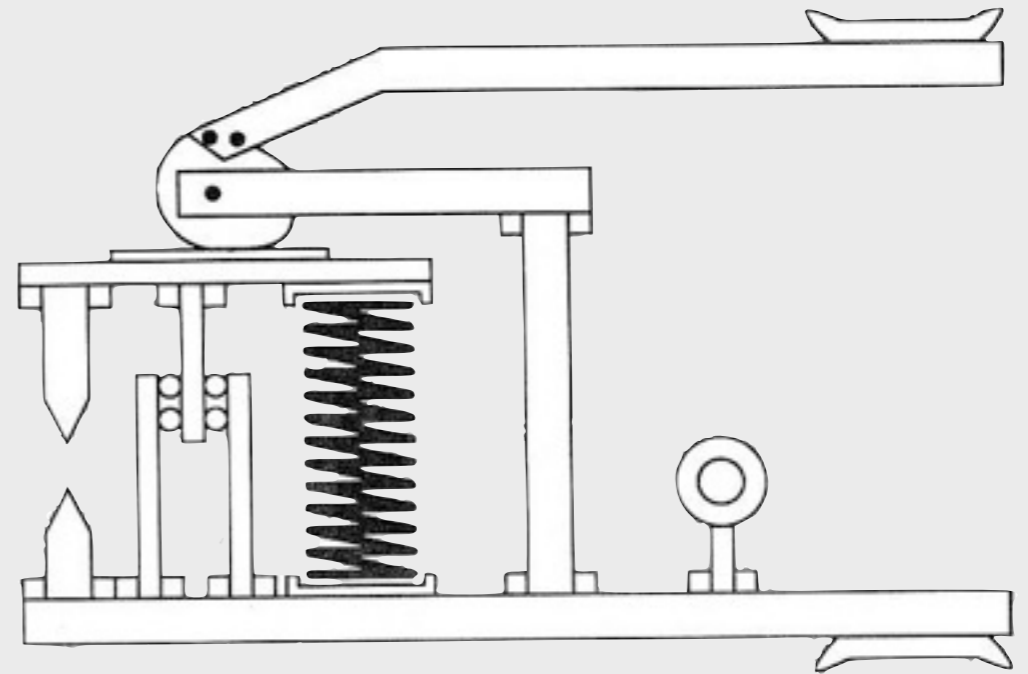
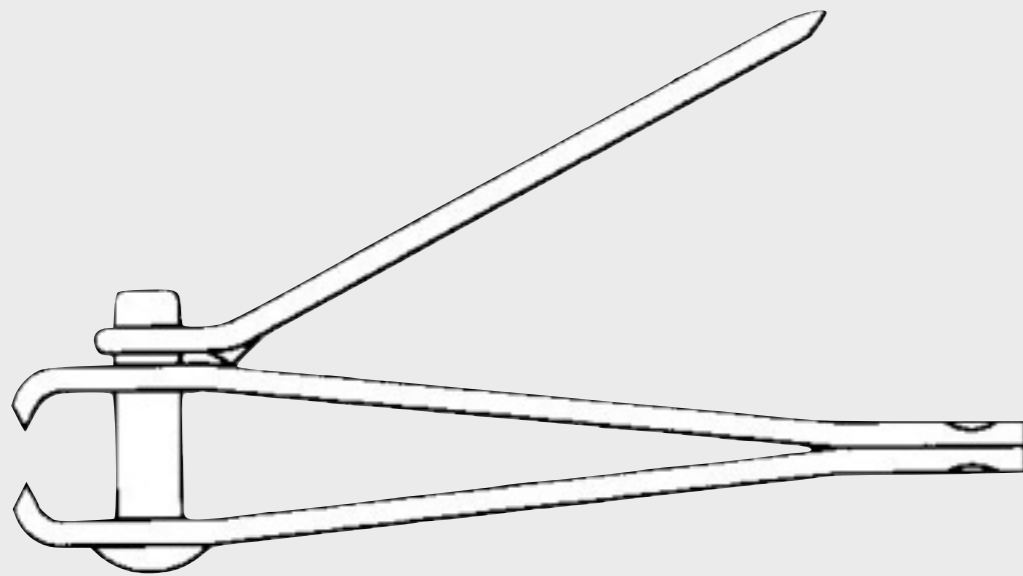

from Karl Ulrich, *Computation and Pre-Parametric Design* (1988)
thanks to Yishai Feldman

when overloading is acceptable

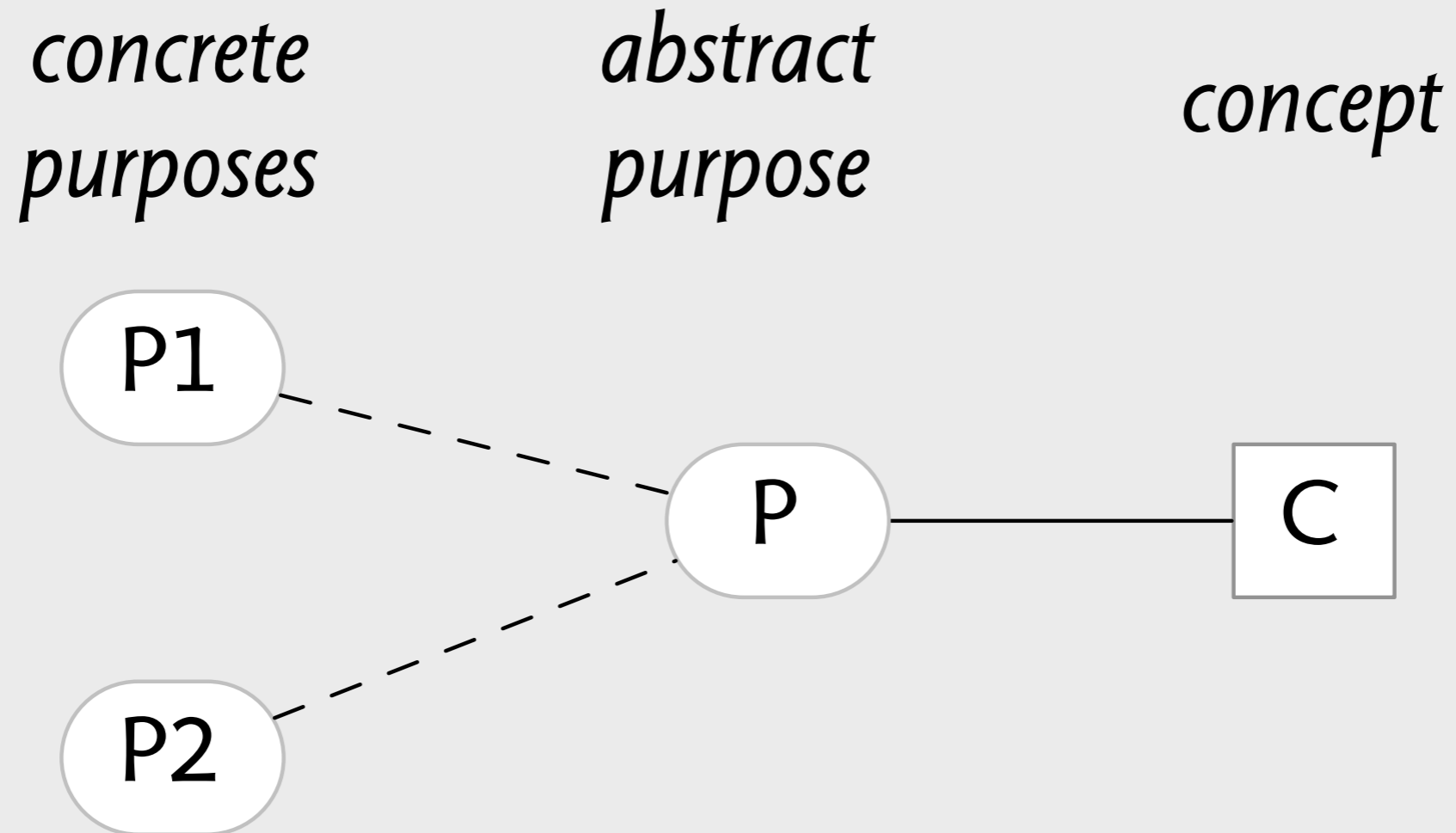

shared concept amazon lists

Your Lists

Your Friends

Find Items Across Your Lists

Wish List (15)

Private

Shopping List (2)

Private

Wish List



Save an idea. Shop for it later.

Add to list



Before They Pass Away

by Jimmy Nelson (Hardcover)

★★★★☆ (149)

\$99.37 ✓ Prime

Price dropped 13% (was \$115.20 when added to List)

In Stock. Offered by Amazon.com.

53 Used & New from \$95.32

[Add comments, quantity & priority](#)



What Can We Believe Where?: Photographs of the American West (Yale University Art Gallery)

by Robert Adams, Joshua Chuang, Jock Reynolds

(Paperback)

★★★★★ (5)

\$23.11 ✓ Prime

Only 7 left in stock--order soon. Offered by Amazon.com.

50 Used & New from \$13.64

[Add comments, quantity & priority](#)

abstract purpose amazon lists

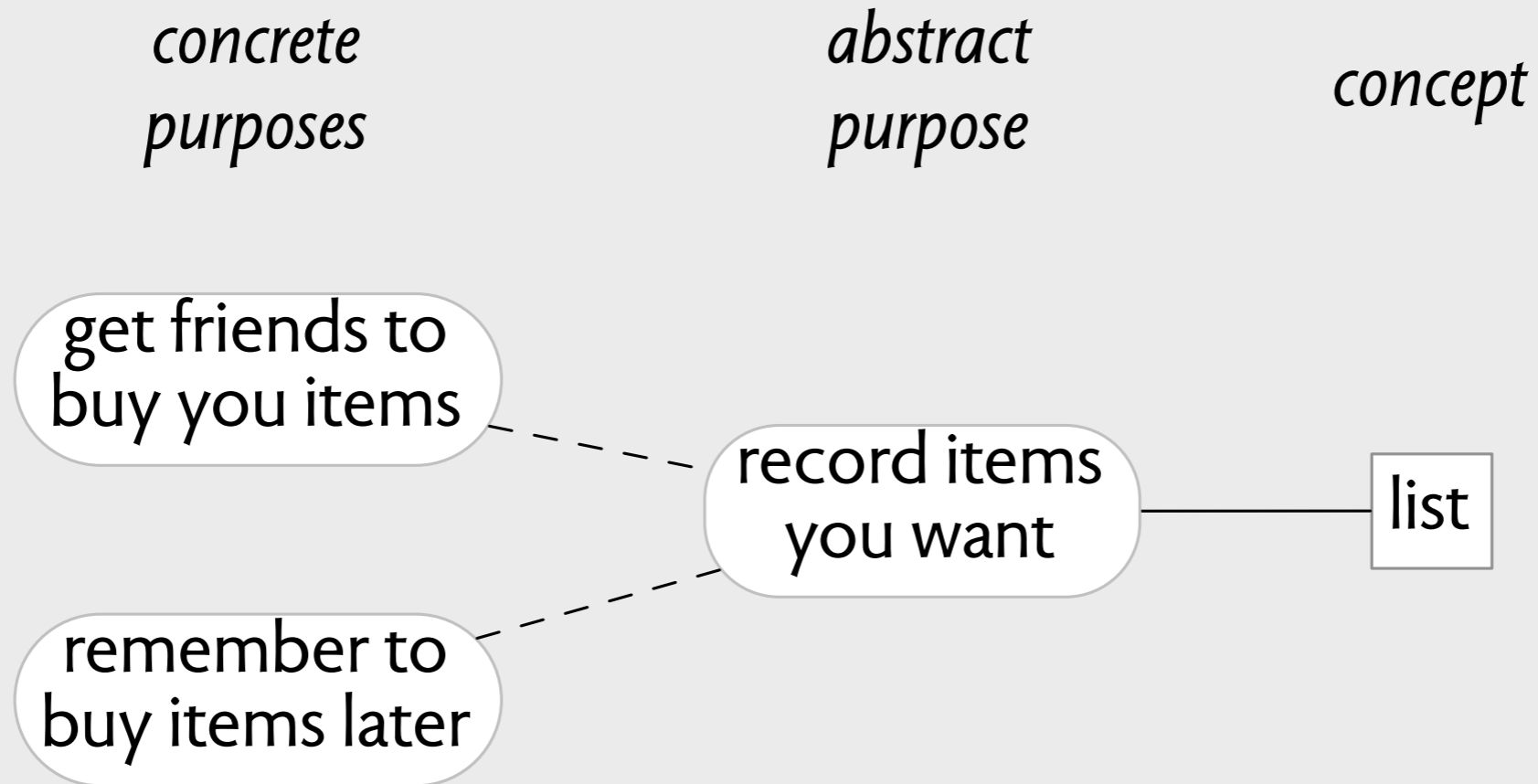

shared concept doodle poll

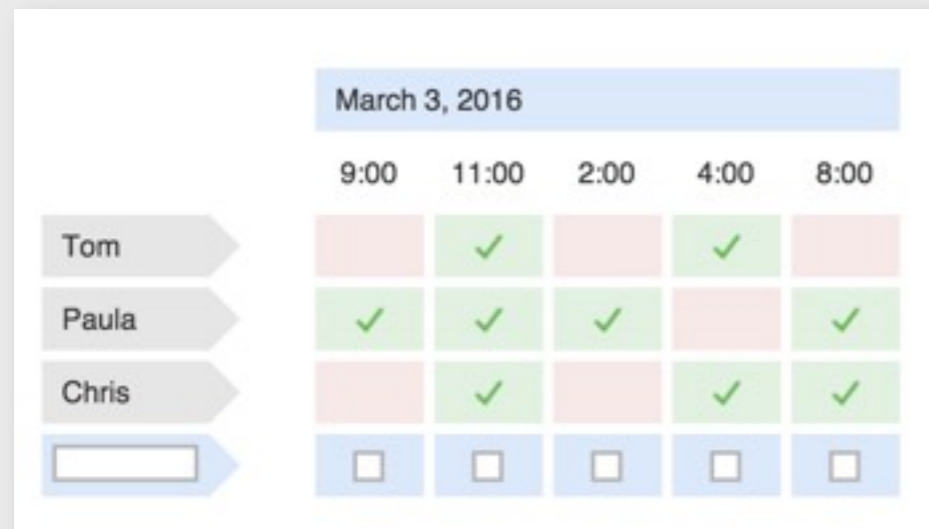

concrete purpose: schedule a meeting



concrete purpose: vote on a choice

shared concept grayscale image in Ps



greyscale image



brushing pixels



brushing pixels in layer mask

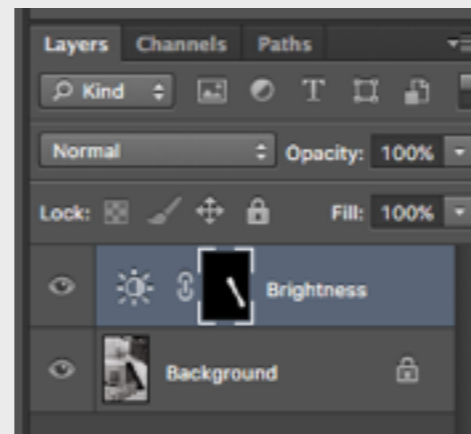

shared concept placeholder

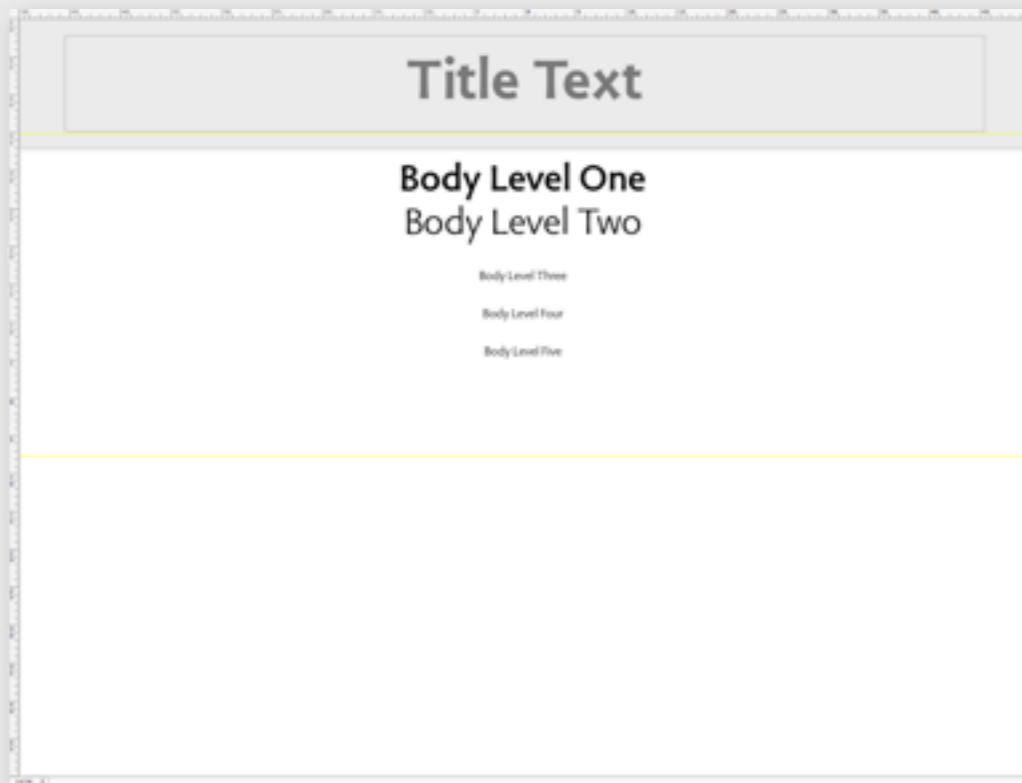

Keynote: no shared concept for title & body

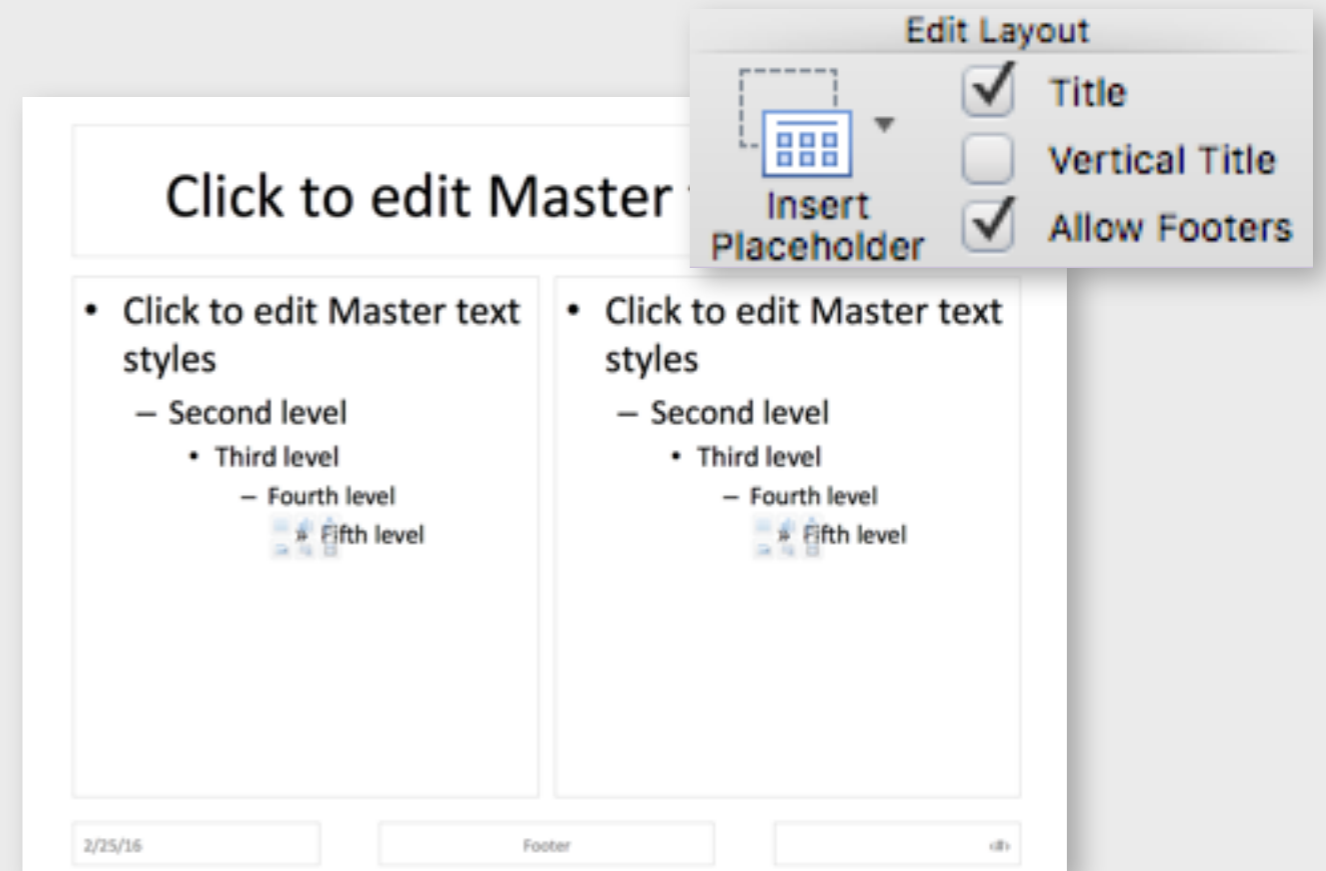

Keynote: shared concept of placeholder

risks of shared concepts

risks of shared concepts

**limited functionality
for concrete
purpose**

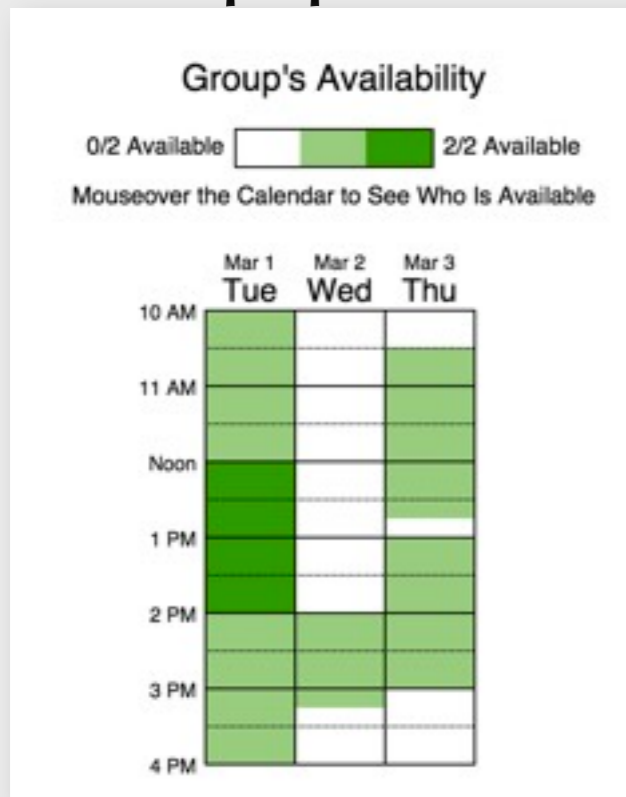

Doodle doesn't offer some scheduling specific functionality that when2meet offers

risks of shared concepts

limited functionality for concrete purpose

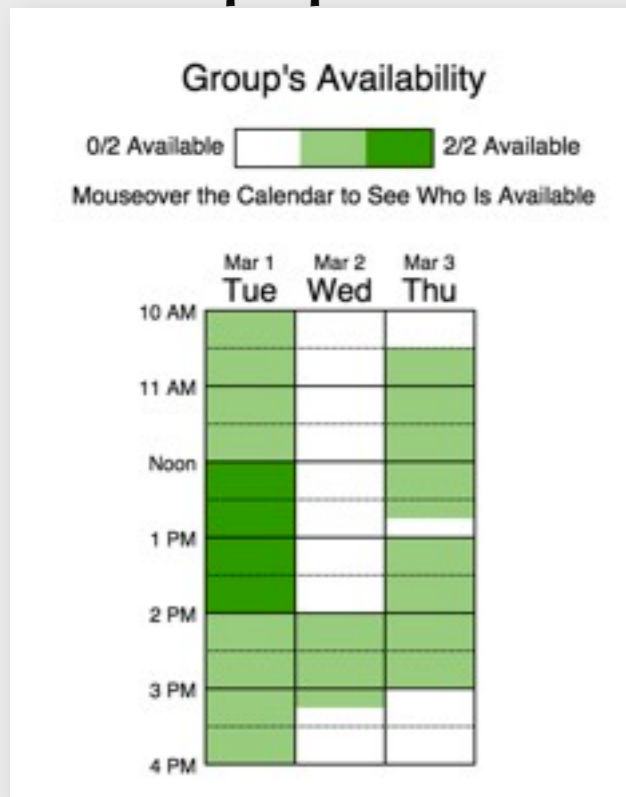

Doodle doesn't offer some scheduling specific functionality that when2meet offers

security & safety oversights



Amazon wishlists privacy risk

<http://www.dailymail.co.uk/news/article-2984542>

risks of shared concepts

limited functionality
for concrete
purpose

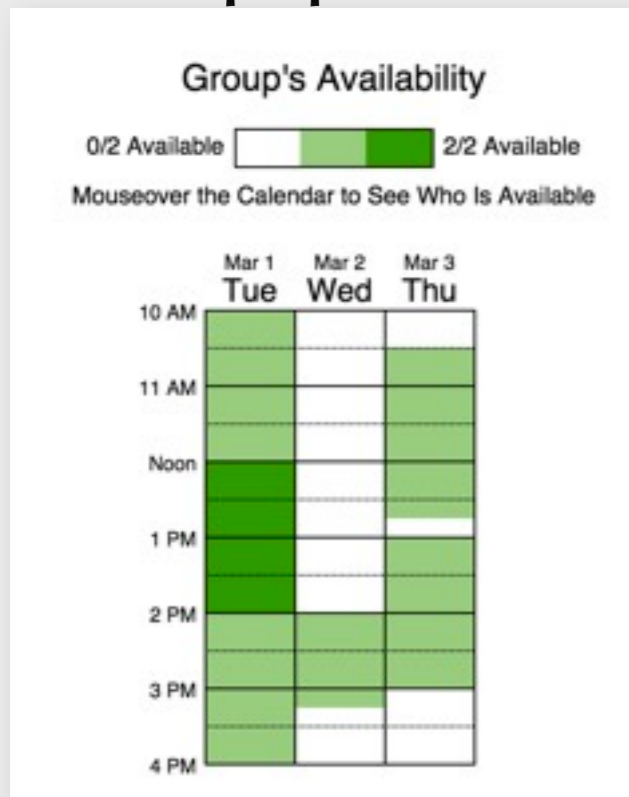

Doodle doesn't offer some scheduling specific functionality that when2meet offers

security & safety
oversights



Amazon wishlists privacy risk

<http://www.dailymail.co.uk/news/article-2984542>

unexpected
couplings

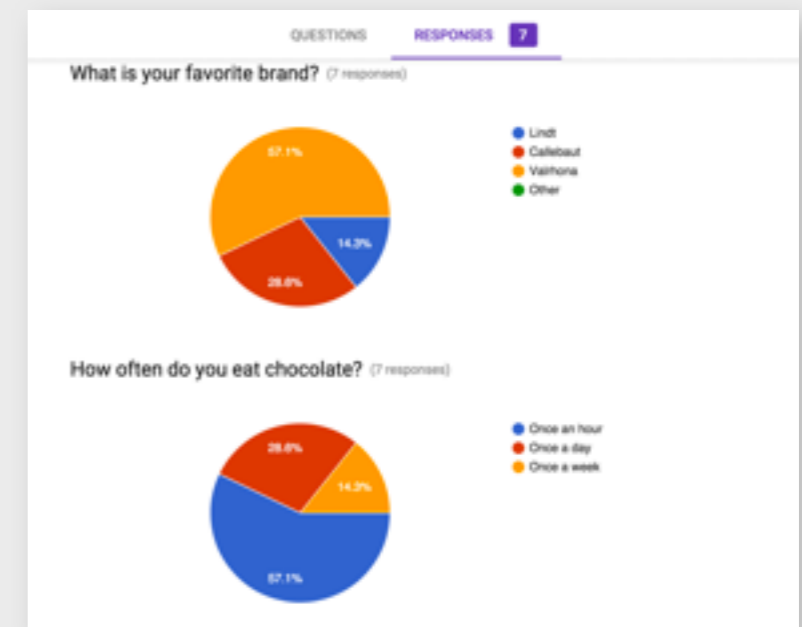

Timestamp	What is your favorite brand?	How often do you eat chocolate?
2/25/2016 8:56:31	Valrhona	Once an hour
2/25/2016 8:56:38	Lindt	Once a day
2/25/2016 8:56:44	Valrhona	Once a day
2/25/2016 8:56:50	Callebaut	Once a week
2/25/2016 8:57:11	Callebaut	Once an hour
2/25/2016 8:57:17	Valrhona	Once an hour
2/25/2016 8:57:22	Valrhona	Once an hour

Google forms: spreadsheet not synced with responses

the root of the problem



Edsger Dijkstra
EWD952

the root of the problem

The rôle of a formal functional specification is simply to act as a logical firewall between two completely different concerns... The **pleasantness problem** concerns the question whether a system... would satisfy our needs... The correctness problem concerns the question whether a given design meets such-and-such a formal functional specification. The logical firewall ... isolates computing science's well-carved niche from the pleasantness problem to which science has little to contribute. Please note that I did not say that the one problem is more important than the other; after all, no chain is stronger than its weakest link.



Edsger Dijkstra
EWD952

user interface levels

shallower

physical level

linguistic level

navigation level

conceptual level

deeper



concept
distinctions

given vs instrumental concepts

given vs instrumental concepts

banking app

overdraft protection loan

automatic bill payment

available funds balance

account balance

given vs instrumental concepts

instrumental:
invented for app

banking app

overdraft protection loan

automatic bill payment

available funds balance

account balance

given vs instrumental concepts

instrumental:
invented for app

banking app

overdraft protection loan

automatic bill payment

available funds balance

given:
preexisted in
domain

account balance

given vs instrumental concepts

instrumental:
invented for app

given:
preexisted in
domain

banking app

overdraft protection loan

automatic bill payment

available funds balance

account balance

travel app

itinerary

agony factor

passenger profile

flight number

reservation

given vs instrumental concepts

instrumental:
invented for app

given:
preexisted in
domain

banking app

overdraft protection loan

automatic bill payment

available funds balance

account balance

social networking app

friendship

tag

post

photo

URL

travel app

itinerary

agony factor

passenger profile

flight number

reservation

given vs instrumental concepts

instrumental:
invented for app

given:
preexisted in
domain

banking app

overdraft protection loan

automatic bill payment

available funds balance

account balance

social networking app

friendship

tag

post

photo

URL

note that all concepts, even given
concepts are a means to an end

travel app

itinerary

agony factor

passenger profile

flight number

reservation

these are not concepts...

these are not concepts...

search

authentication

these are not concepts...

search

authentication

purposes

these are not concepts...

search

authentication

purposes

concepts

search string

certificate

these are not concepts...

search

authentication

DOM element

HTTP request

purposes

concepts

implementation details

search string

certificate

these are not concepts...

search

authentication

purposes

concepts

search string

certificate

DOM element

HTTP request

implementation details

concepts

web page

link

these are not concepts...

search authentication

purposes

concepts

search string certificate

DOM element HTTP request

implementation details

concepts

web page link

but this is a concept for a user of the jQuery API (vs. a user of Chrome)

orthogonality
& uniformity

orthogonality

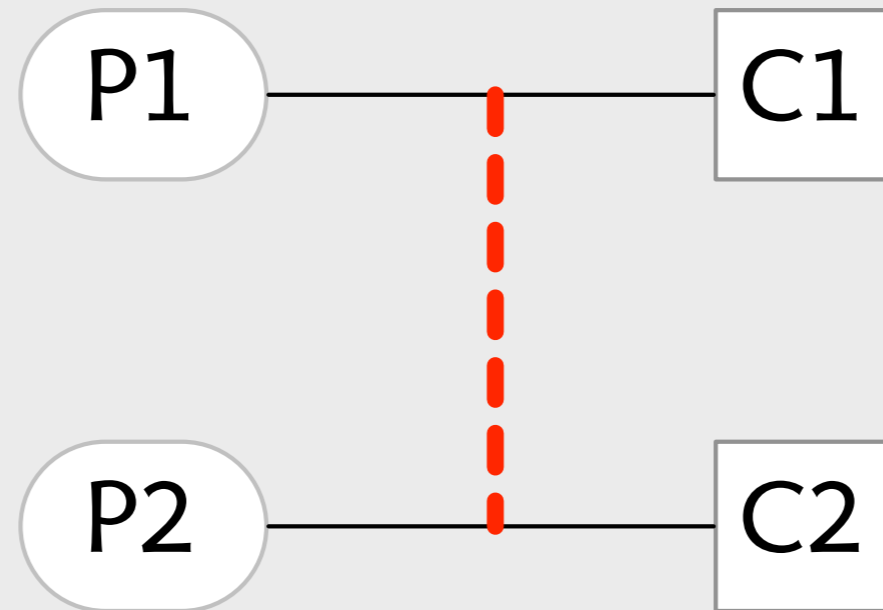

orthogonality is violated when one concept's fitness for purpose is undermined by another concept

non-orthogonal concepts

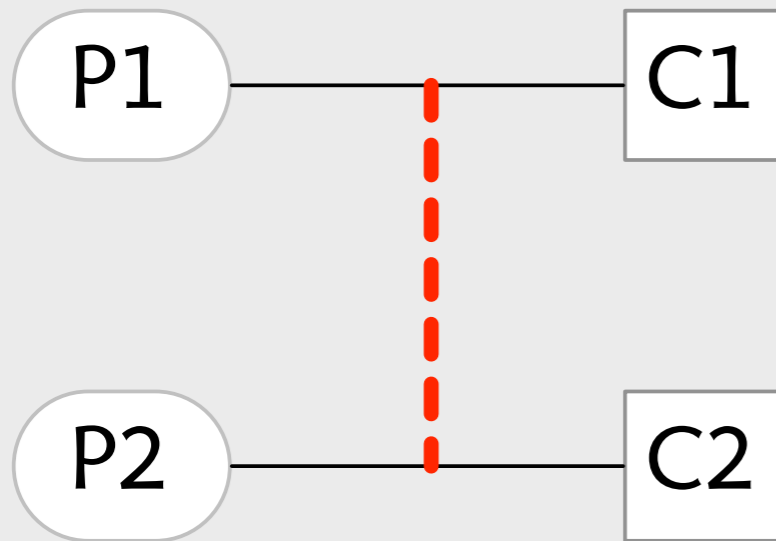

non-orthogonal concepts

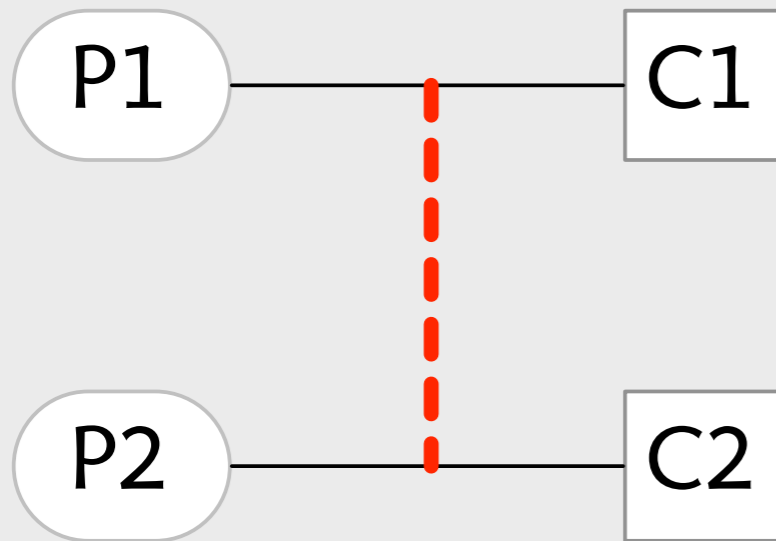

origin, space, exclusion (CSS)
4 position values for $2 \times 3 \times 2$ options

non-orthogonal concepts

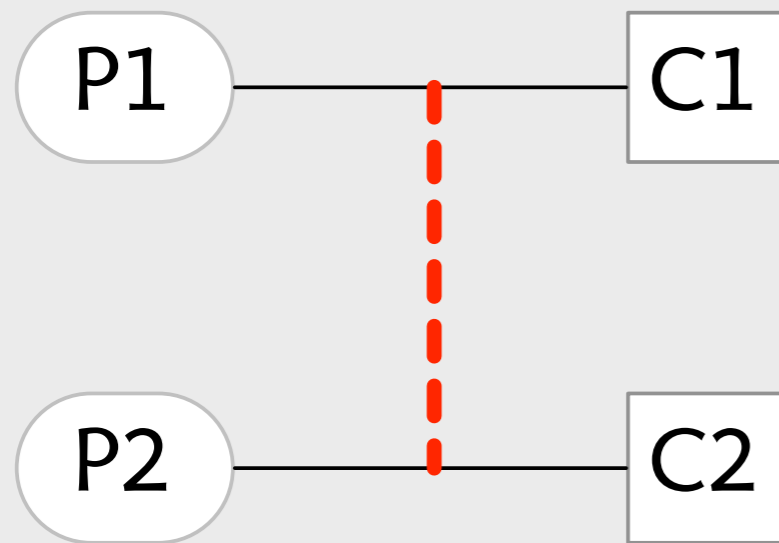

origin, space, exclusion (CSS)
4 position values for $2 \times 3 \times 2$ options

conversation & label (Gmail)
same subject, get same label

non-orthogonal concepts

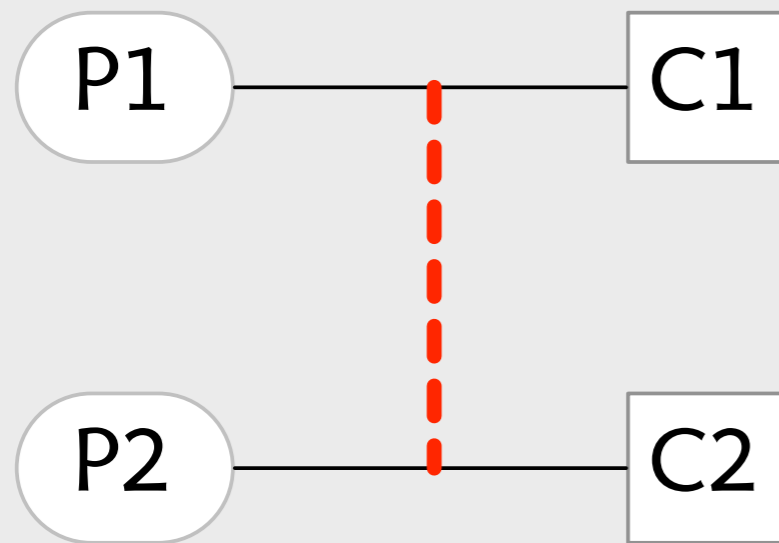

origin, space, exclusion (CSS)
4 position values for $2 \times 3 \times 2$ options

conversation & label (Gmail)
same subject, get same label

listserv & bcc (SMTP)
modified subject reveals target

non-orthogonal concepts

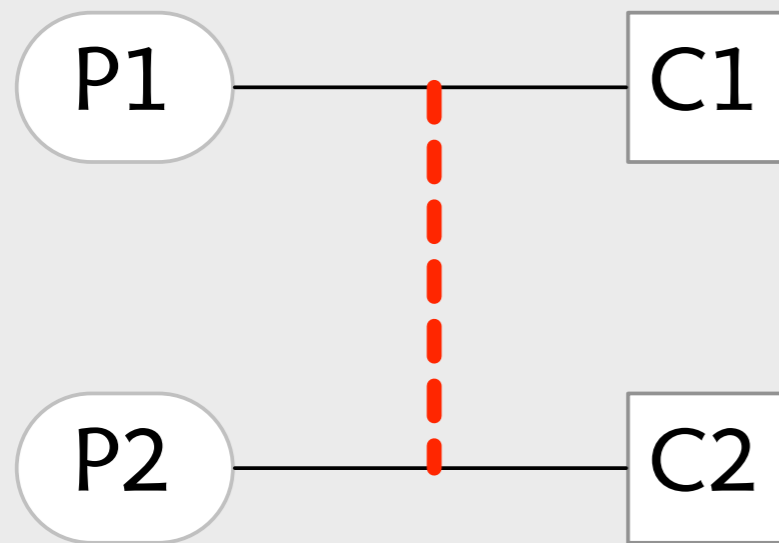

origin, space, exclusion (CSS)
4 position values for $2 \times 3 \times 2$ options

conversation & label (Gmail)
same subject, get same label

listserv & bcc (SMTP)
modified subject reveals target

title & reply (Tumblr)
adding ? to title enables replies (!)

non-orthogonal concepts

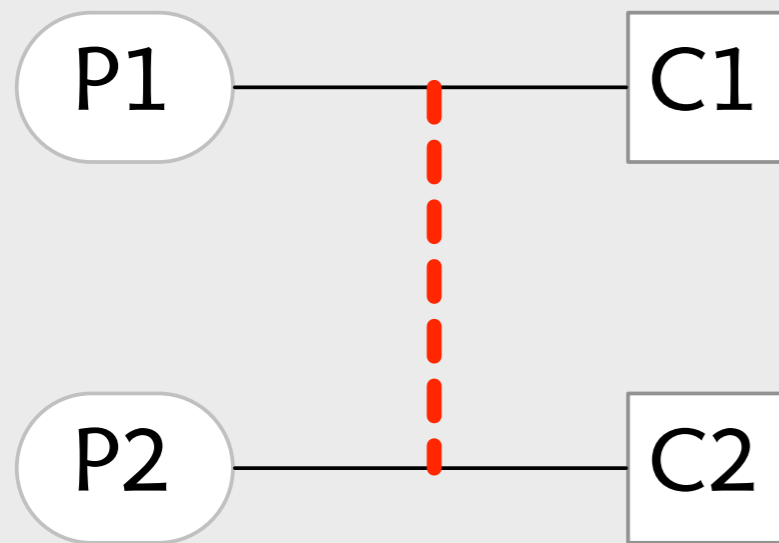

origin, space, exclusion (CSS)
4 position values for $2 \times 3 \times 2$ options

conversation & label (Gmail)
same subject, get same label

listserv & bcc (SMTP)
modified subject reveals target

title & reply (Tumblr)
adding ? to title enables replies (!)

group & selection (many old apps)
can't select object in a group

non-orthogonal concepts

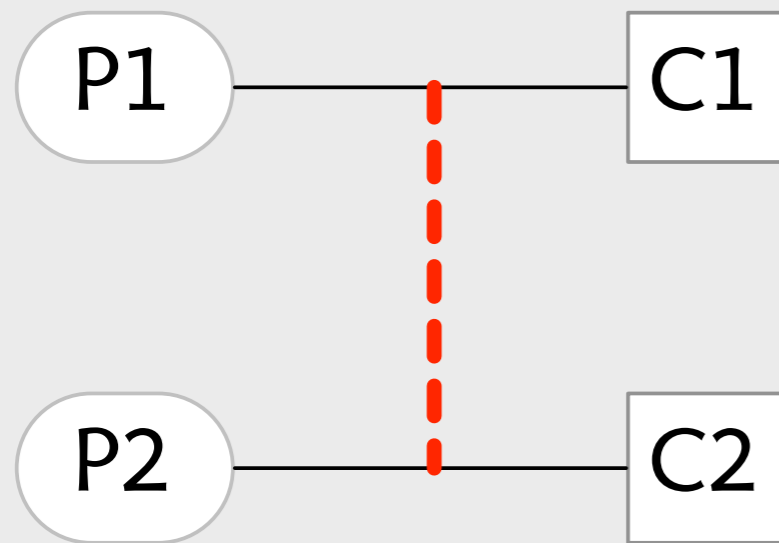

origin, space, exclusion (CSS)
4 position values for $2 \times 3 \times 2$ options

conversation & label (Gmail)
same subject, get same label

listserv & bcc (SMTP)
modified subject reveals target

title & reply (Tumblr)
adding ? to title enables replies (!)

group & selection (many old apps)
can't select object in a group

group & connector (Keynote 5.3)
can't select box if connected

non-orthogonal concepts

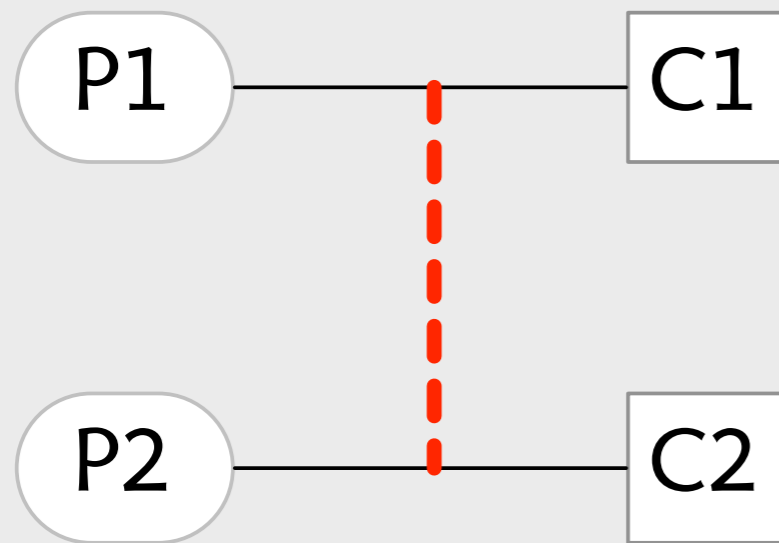

Shriram Krishnamurthi
BCC example

origin, space, exclusion (CSS)
4 position values for $2 \times 3 \times 2$ options

conversation & label (Gmail)
same subject, get same label

listserv & bcc (SMTP)
modified subject reveals target

title & reply (Tumblr)
adding ? to title enables replies (!)

group & selection (many old apps)
can't select object in a group

group & connector (Keynote 5.3)
can't select box if connected

non-orthogonal concepts gmail

from Eunsuk Kang

Eunsuk Kang <eskang@csail.mit.edu>

To: Daniel Jackson <dnj@MIT.EDU> , Santiago Perez De Rosso <sperezde@csail.mit.edu>

an example of bad coupling in gmail?

December 11, 2014 2:27 AM

[Hide Details](#)

[Conceptual Design](#) ↑

Hi Daniel, Santiago,

I am not sure whether this falls into one of the conceptual design issues that you have been analyzing, but here's a little annoyance that I just ran into using labels in Gmail.

This evening, I made two separate reservations with Enterprise (one in Phoenix and another one in Vegas), and the company sent me a confirmation e-mail for each one of them. Usually, I tag travel-related e-mails using a label (e.g. "Vegas Trip 2014") so that I can easily find all the relevant e-mails for a particular trip. Now, the problem is that Gmail automatically grouped the two Enterprise emails into a single conversation. It turns out that in Gmail, a label applied to an e-mail in a conversation is applied to every other e-mail in the same conversation. This means I can't assign separate labels to the two car rentals! Uggh!

(By the way, is it possible to take an e-mail out of a conversation? Either this is impossible or the Gmail UI does not make this easy).

Eunsuk

conversations interfere with labels

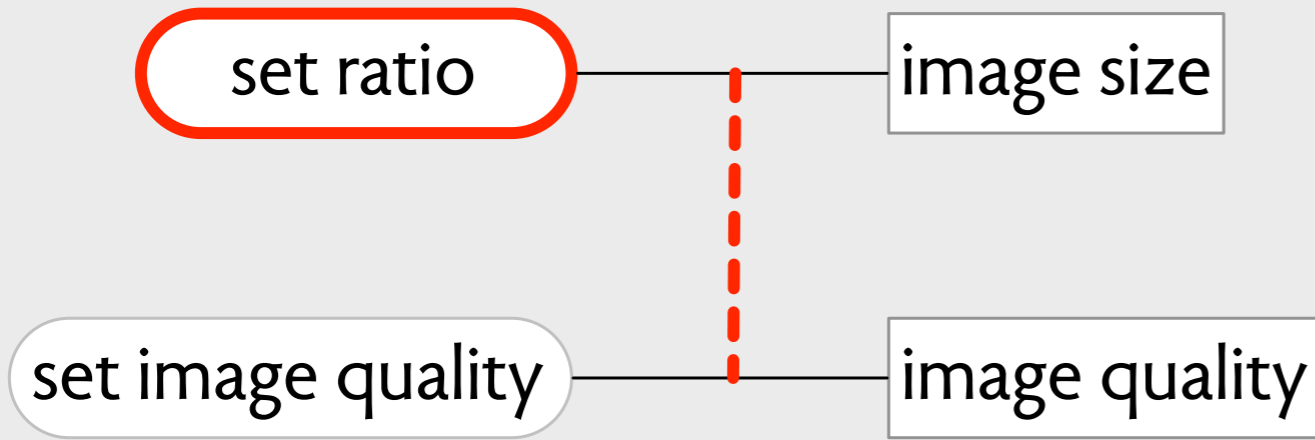

an orthogonality violation

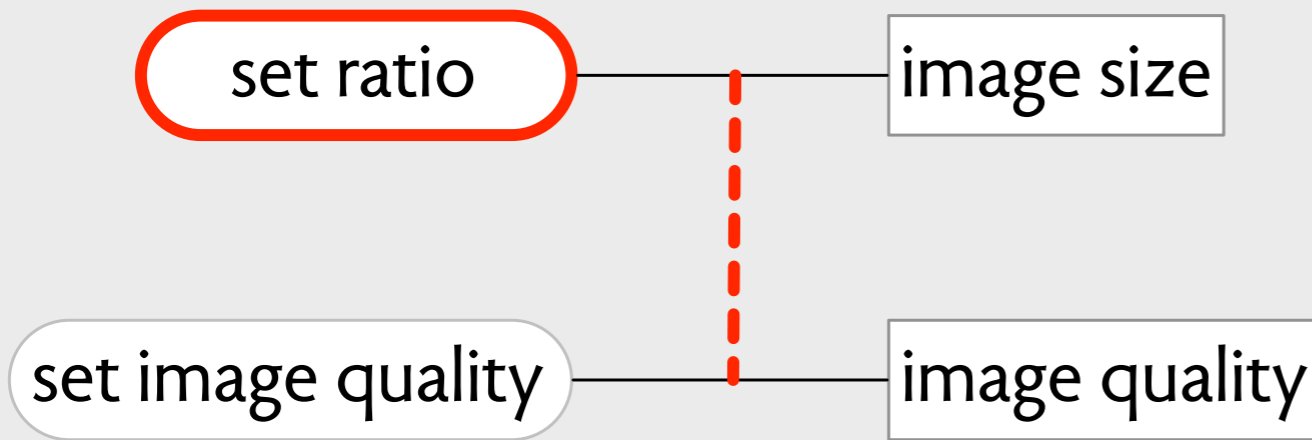

an orthogonality violation

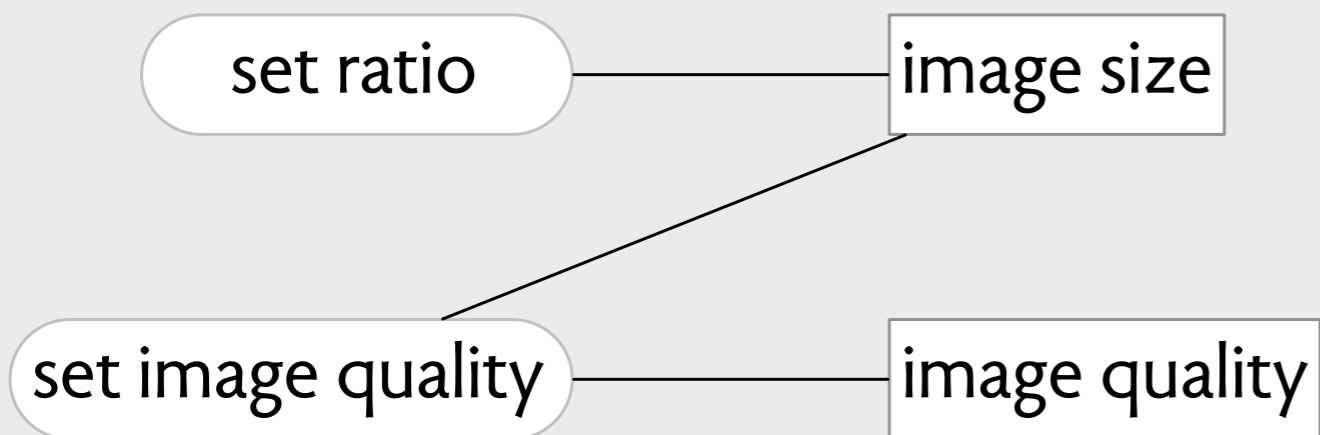

overloaded concept too

uniformity

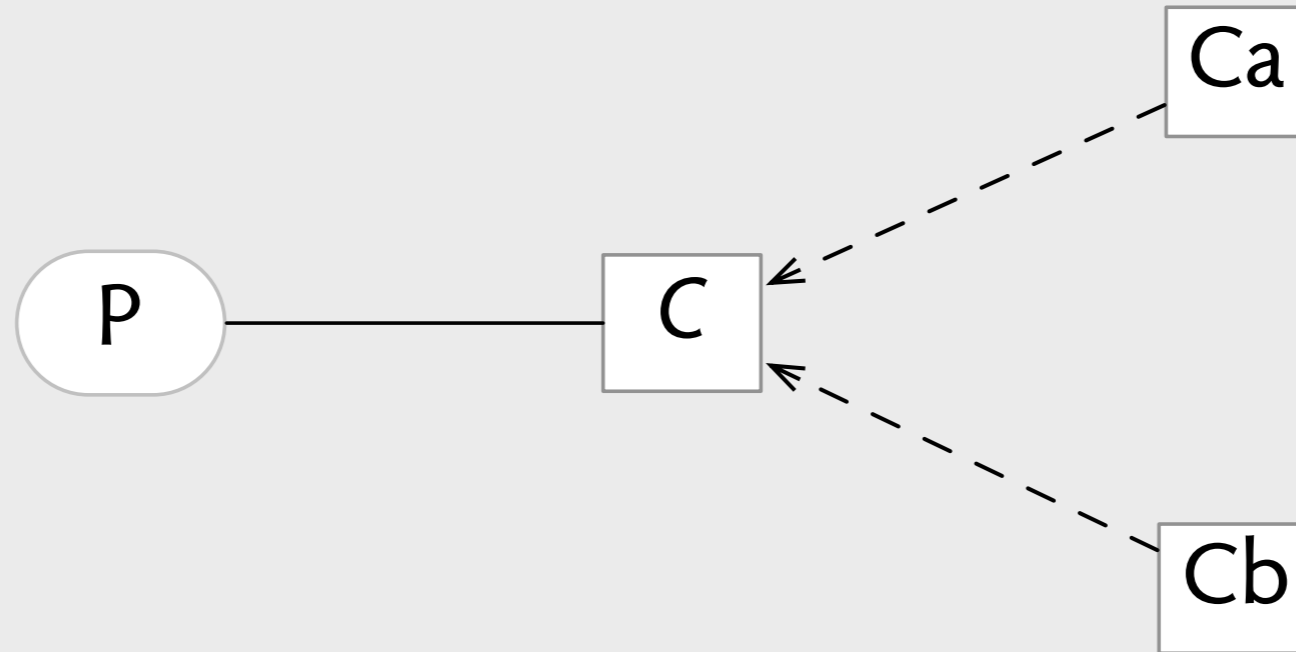

uniformity is violated when instantiations differ with respect to fulfillment of purpose

uniformity

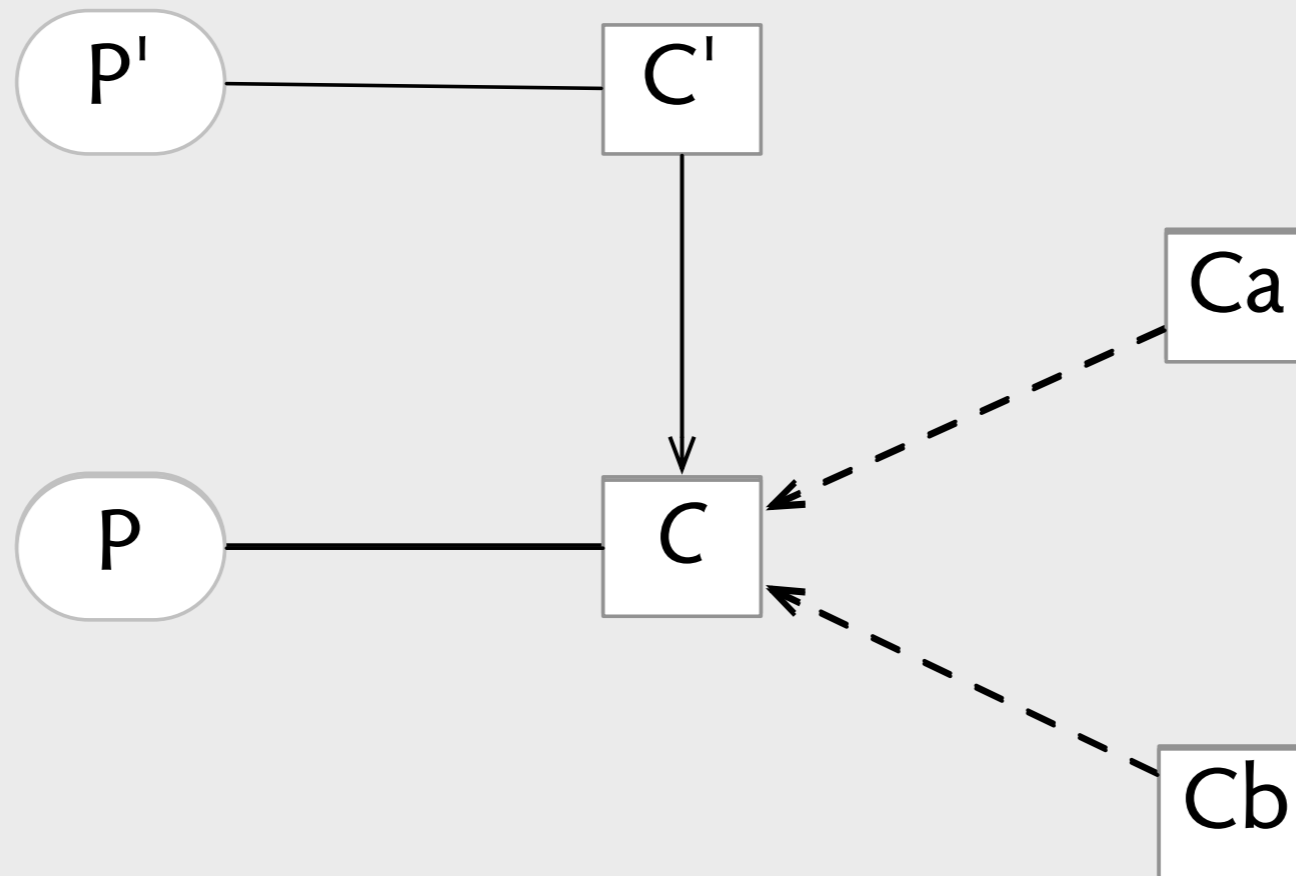

uniformity is violated when instantiations differ with respect to fulfillment of purpose

... directly or indirectly

uniformity

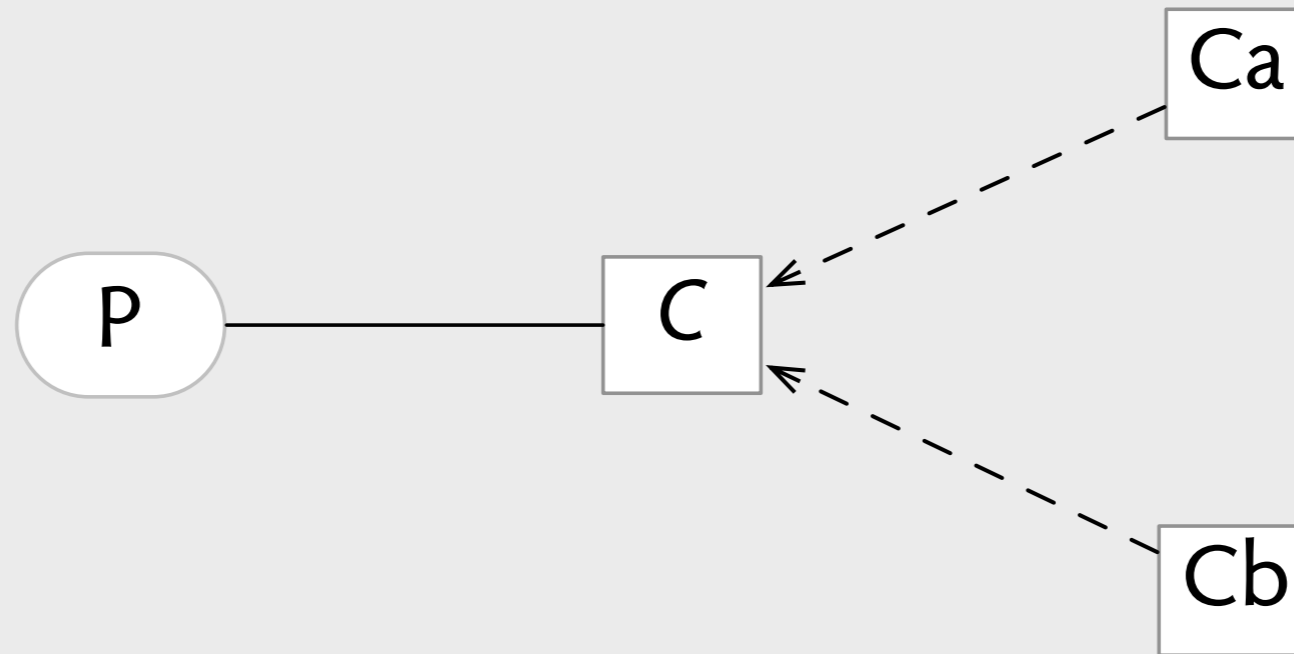

uniformity is violated when a concept has different versions or instantiations that behave differently for no good reason

non-uniform concepts

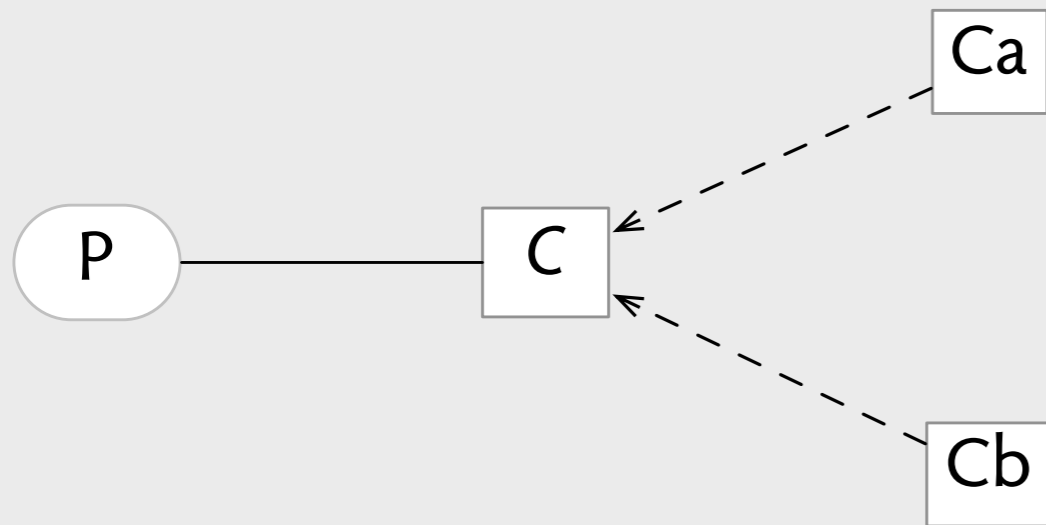

non-uniform concepts

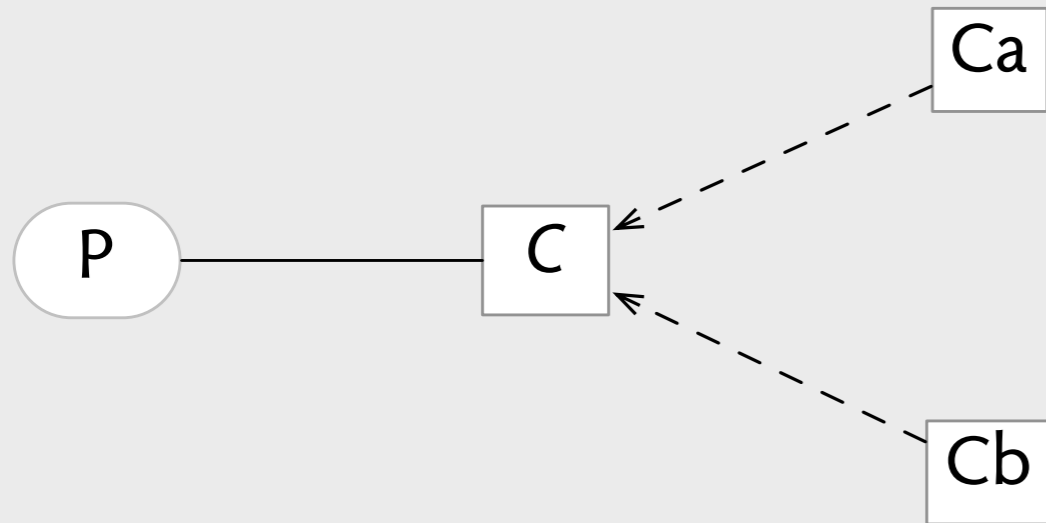

deposits by check (banking)
funds arrive before clearing

non-uniform concepts

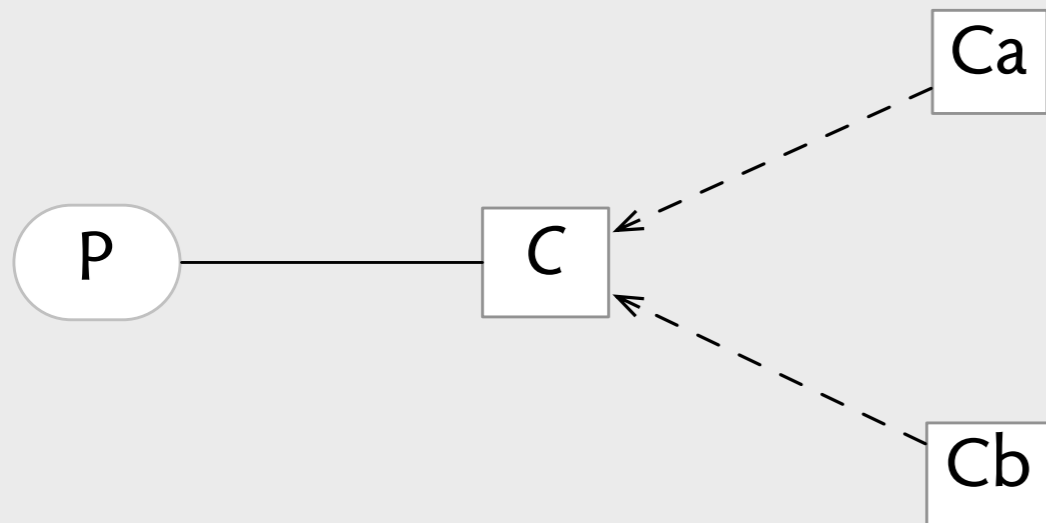

deposits by check (banking)
funds arrive before clearing

primitive type (Java)
not like a class type

non-uniform concepts

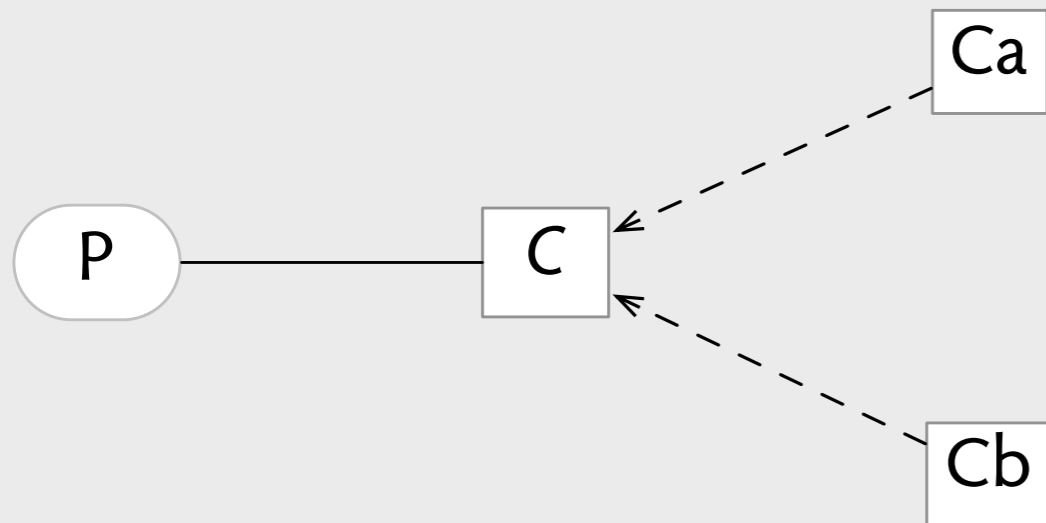

deposits by check (banking)
funds arrive before clearing

primitive type (Java)
not like a class type

direct flight (Official Airline Guides)
1 flight number, but >1 stop

non-uniform concepts

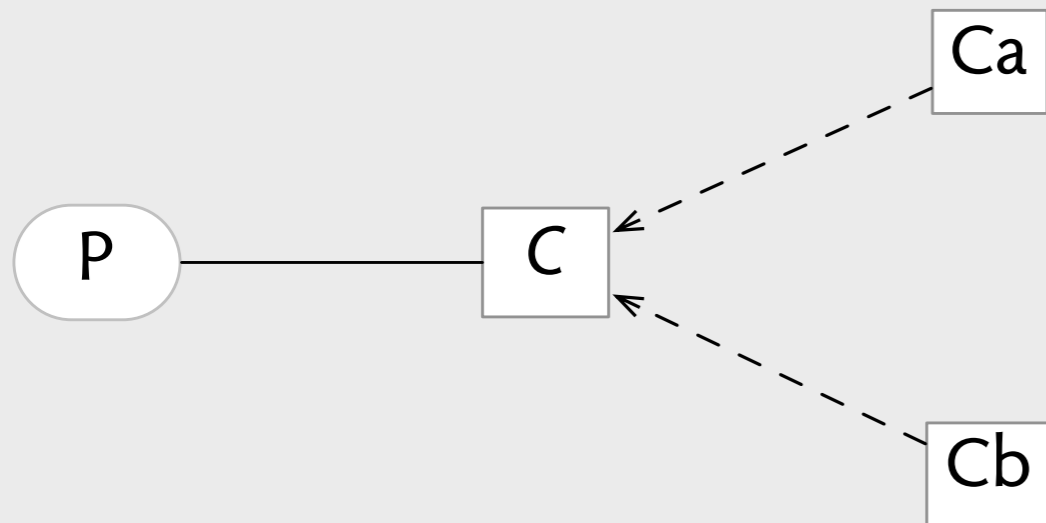

deposits by check (banking)
funds arrive before clearing

primitive type (Java)
not like a class type

direct flight (Official Airline Guides)
1 flight number, but >1 stop

alerts (Apple iCal)
can't select email alerts for default

non-uniform concepts

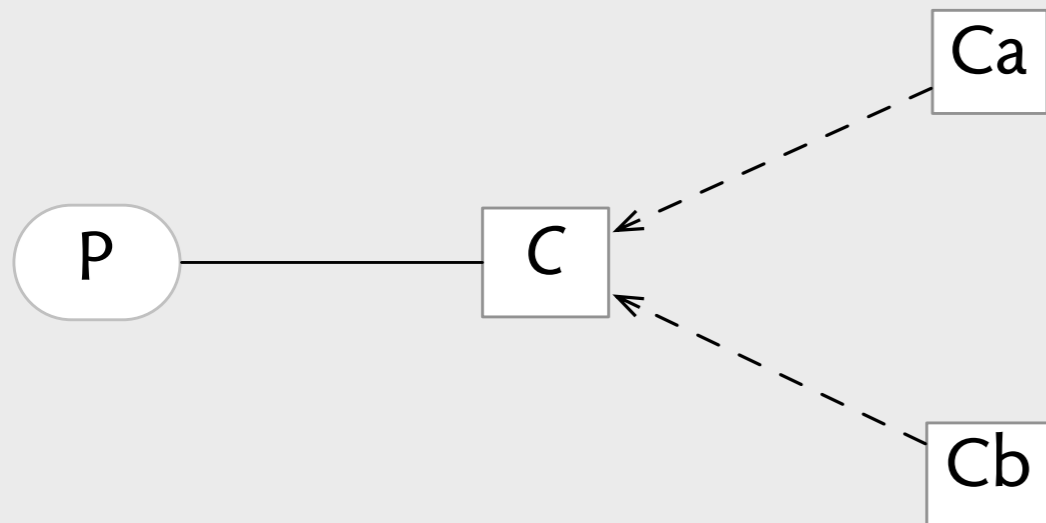

deposits by check (banking)
funds arrive before clearing

primitive type (Java)
not like a class type

direct flight (Official Airline Guides)
1 flight number, but >1 stop

alerts (Apple iCal)
can't select email alerts for default

custom settings (Fuji x100s)
only some settings selectable

conceptual
acrobatics

Field Trip Permission Form

Dear Parents:

Ms. Frizzle will again be taking her second grade class on an exciting field trip. Please sign and return the permission slip below.

Thank you!

Yes, I give permission for my child to go on the second grade "Touch and Feel" trip on Friday February 13th to the NastyCo Nuclear Dump. I understood that my child may encounter the normal risks of childhood play, including grazed knees, hurt feelings and exposure to toxic waste.

Parents signature

Date

Field Trip Permission Form

Dear Parents:

Ms. Frizzle will again be taking her second grade class on an exciting field trip. Please sign and return the permission slip below.

Thank you!

Yes, I give permission for my child to go on the second grade "Touch and Feel" trip on Friday February 13th to the NastyCo Nuclear Dump. I understood that my child may encounter the normal risks of childhood play, including grazed knees, hurt feelings and exposure to toxic waste.

Count Olaf

Parents signature

Date

Field Trip Permission Form

Dear Parents:

Ms. Frizzle will again be taking her second grade class on an exciting field trip. Please sign and return the permission slip below.

Thank you!

Yes, I give permission for my child to go on the second grade "Touch and Feel" trip on Friday February 13th to the NastyCo Nuclear Dump. I understood that my child may encounter the normal risks of childhood play, including grazed knees, hurt feelings and exposure to toxic waste.

Count Olaf

February 11, 2013

Parents signature

Date

acrobat to the rescue

acrobat to the rescue

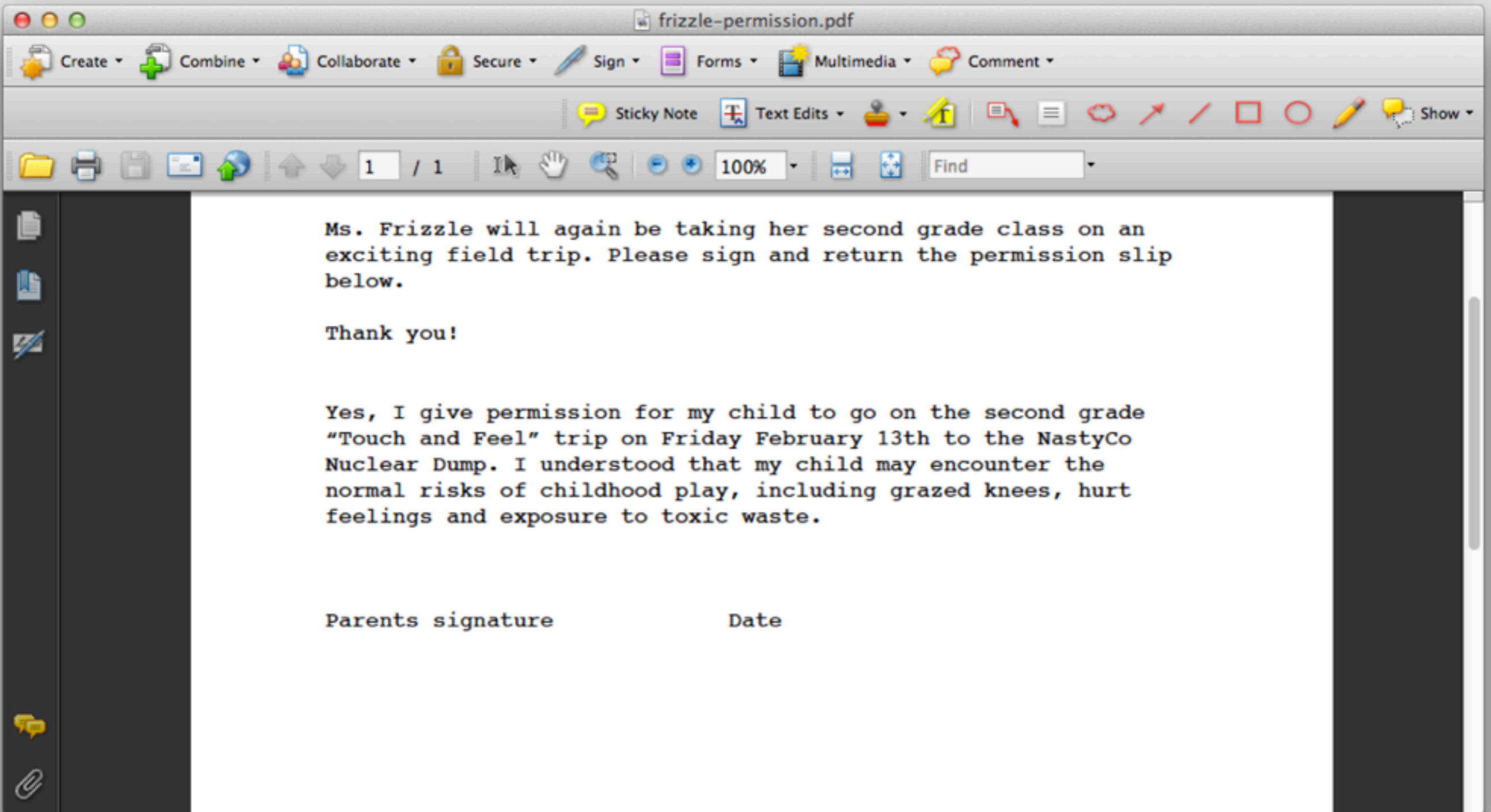

acrobat to the rescue

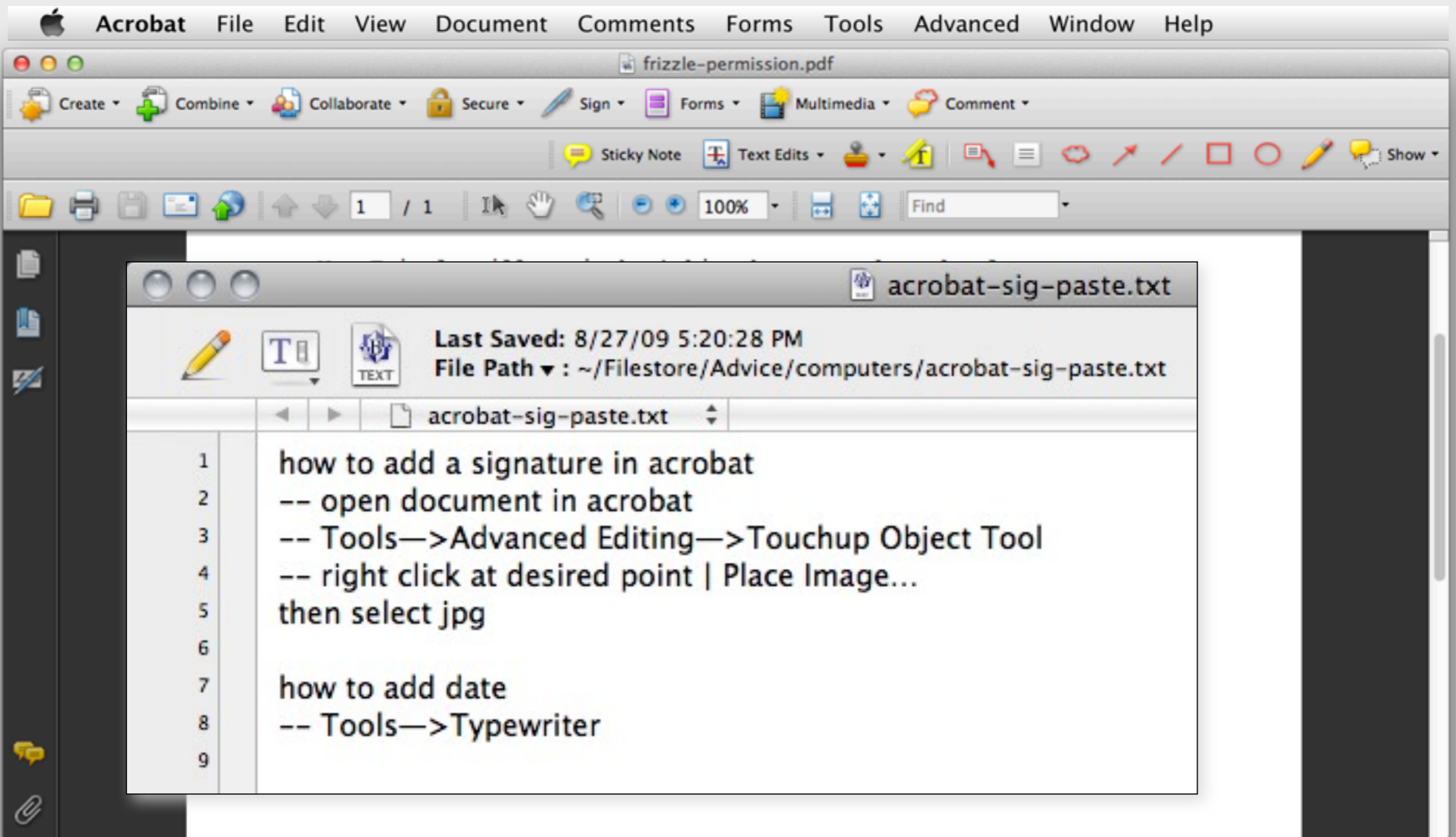

acrobat to the rescue

The screenshot shows the Adobe Acrobat application window. The menu bar includes Apple logo, Acrobat, File, Edit, View, Document, Comments, Forms, Tools, Advanced, Window, and Help. The Tools menu is open, listing options: Comment & Markup, Select & Zoom, Advanced Editing (highlighted), Typewriter, Analysis, Multimedia, and Customize Toolbars... A secondary menu is open under Advanced Editing, listing: Select Object Tool, Button, Article Tool, Crop Tool, Link Tool, TouchUp Text Tool, TouchUp Reading Order Tool, and TouchUp Object Tool (checked). The document content is a permission slip form with the following text:

frizzle-permission...

Create Combine Collaborate Secure Sign Forms Multimedia Comment

Sticky Note Text Edits

1 / 1 100%

Ms. Frizzle will again be taking her second grade class on an exciting field trip. Please sign and return the permission slip below.

Thank you!

Yes, I give permission for my child to go on the second grade "Touch and Feel" trip on Friday February 13th to the NastyCo Nuclear Dump. I understood that my child may encounter the normal risks of childhood play, including grazed knees, hurt feelings and exposure to toxic waste.

Parents signature Date

acrobat to the rescue

The screenshot displays the Adobe Acrobat application window. The menu bar at the top includes 'Acrobat', 'File', 'Edit', 'View', 'Document', 'Comments', 'Forms', 'Tools', 'Advanced', 'Window', and 'Help'. The 'Tools' menu is open, showing options: 'Comment & Markup', 'Select & Zoom', 'Advanced Editing' (highlighted), 'Typewriter', 'Analysis', 'Multimedia', and 'Customize Toolbars...'. A secondary menu is open from 'Advanced Editing', listing tools: 'Select Object Tool', 'Button', 'Article Tool', 'Crop Tool', 'Link Tool', 'TouchUp Text Tool', 'TouchUp Reading Order Tool', and 'TouchUp Object Tool' (checked). Below the menu, a document page is visible with the following text:

Ms. Frizzle will again be taking her second grade class on an exciting field trip. Please sign and return the permission slip below.

Thank you!

Yes, I give permission for my child to go on the second grade "Touch and Feel" trip on Friday February 13th to the NastyCo Nuclear Dump. I understood that my child may encounter the normal risks of childhood play, including grazed knees, hurt feelings and exposure to toxic waste.

Parents _____ Date _____

A context menu is open over the 'Parents' field, containing the options: 'Select All', 'Place Image...' (highlighted), 'Find...', and 'Edit Page...'. The bottom of the screen shows a sidebar with icons for document, comments, and a paperclip.

what we hate ... & love

what we hate ... & love



Adobe Acrobat is a family of computer programs developed by Adobe Systems, designed to view, create, manipulate and manage files ... »

47% Love Acrobat



Tweet 1

+1

207 Positive Opinions out of 444



Adobe Acrobat is a family of computer programs developed by Adobe Systems, designed to view, create, manipulate and manage files ... »

53% Hate Acrobat



Tweet 15

+1

237 Negative Opinions out of 444

what we hate ... & love



Adobe Acrobat is a family of computer programs developed by Adobe Systems, designed to view, create, manipulate and manage files ... »

47% Love Acrobat



Tweet 1



207 Positive Opinions out of 444



Adobe Acrobat is a family of computer programs developed by Adobe Systems, designed to view, create, manipulate and manage files ... »

53% Hate Acrobat



Tweet 15



237 Negative Opinions out of 444



Adobe Photoshop Lightroom is a photography software program developed by Adobe Systems for Mac OS X and Microsoft Windows, designed ... »

89% Love Lightroom



Tweet 3



2,335 Positive Opinions out of 2,632



Adobe Photoshop Lightroom is a photography software program developed by Adobe Systems for Mac OS X and Microsoft Windows, designed ... »

11% Hate Lightroom



Tweet 5



297 Negative Opinions out of 2,632

what we hate ... & love



Adobe Acrobat is a family of computer programs developed by Adobe Systems, designed to view, create, manipulate and manage files ... »

47% Love Acrobat



Tweet 1



207 Positive Opinions out of 444



Adobe Photoshop is a graphics editing program developed and published by Adobe Systems Incorporated.

70% Love Photoshop



Tweet 87



30,305 Positive Opinions out of 43,283



Adobe Photoshop Lightroom is a photography software program developed by Adobe Systems for Mac OS X and Microsoft Windows, designed ... »

89% Love Lightroom



Tweet 3



2,335 Positive Opinions out of 2,632



Adobe Acrobat is a family of computer programs developed by Adobe Systems, designed to view, create, manipulate and manage files ... »

53% Hate Acrobat



Tweet 15



237 Negative Opinions out of 444



Adobe Photoshop is a graphics editing program developed and published by Adobe Systems Incorporated.

30% Hate Photoshop

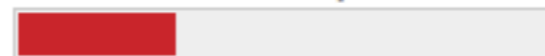

Tweet 105



12,978 Negative Opinions out of 43,283



Adobe Photoshop Lightroom is a photography software program developed by Adobe Systems for Mac OS X and Microsoft Windows, designed ... »

11% Hate Lightroom

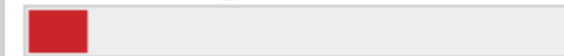

Tweet 5



297 Negative Opinions out of 2,632

cropping in adobe lightroom

cropping in adobe lightroom

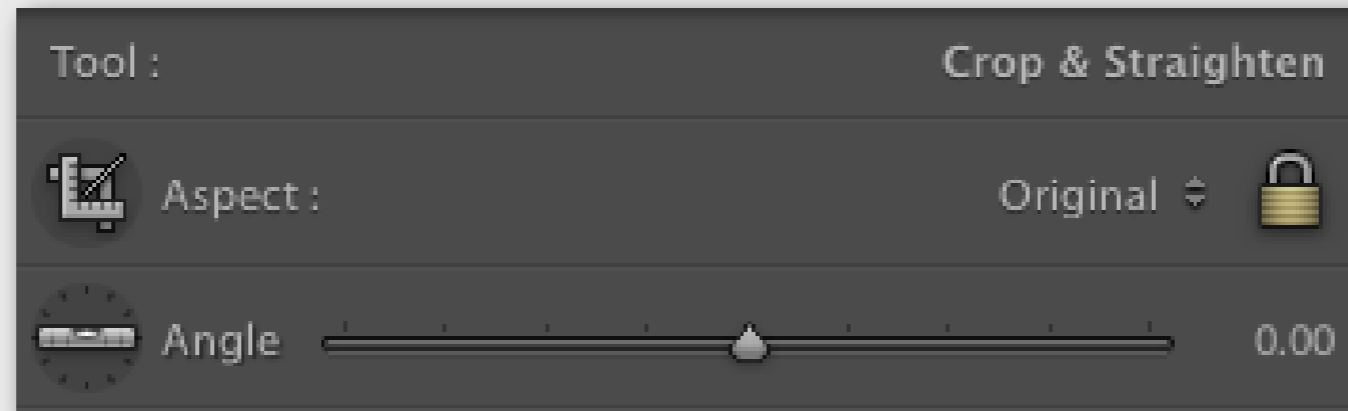

cropping photoshop

cropping photoshop

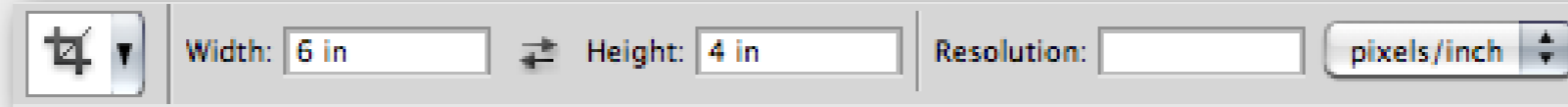

cropping photoshop

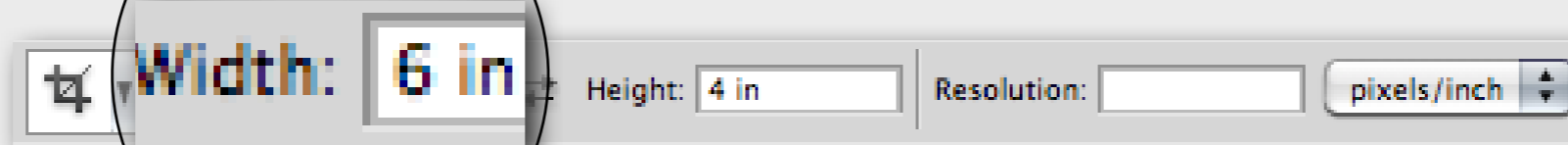

cropping the whole image



cropping the whole image

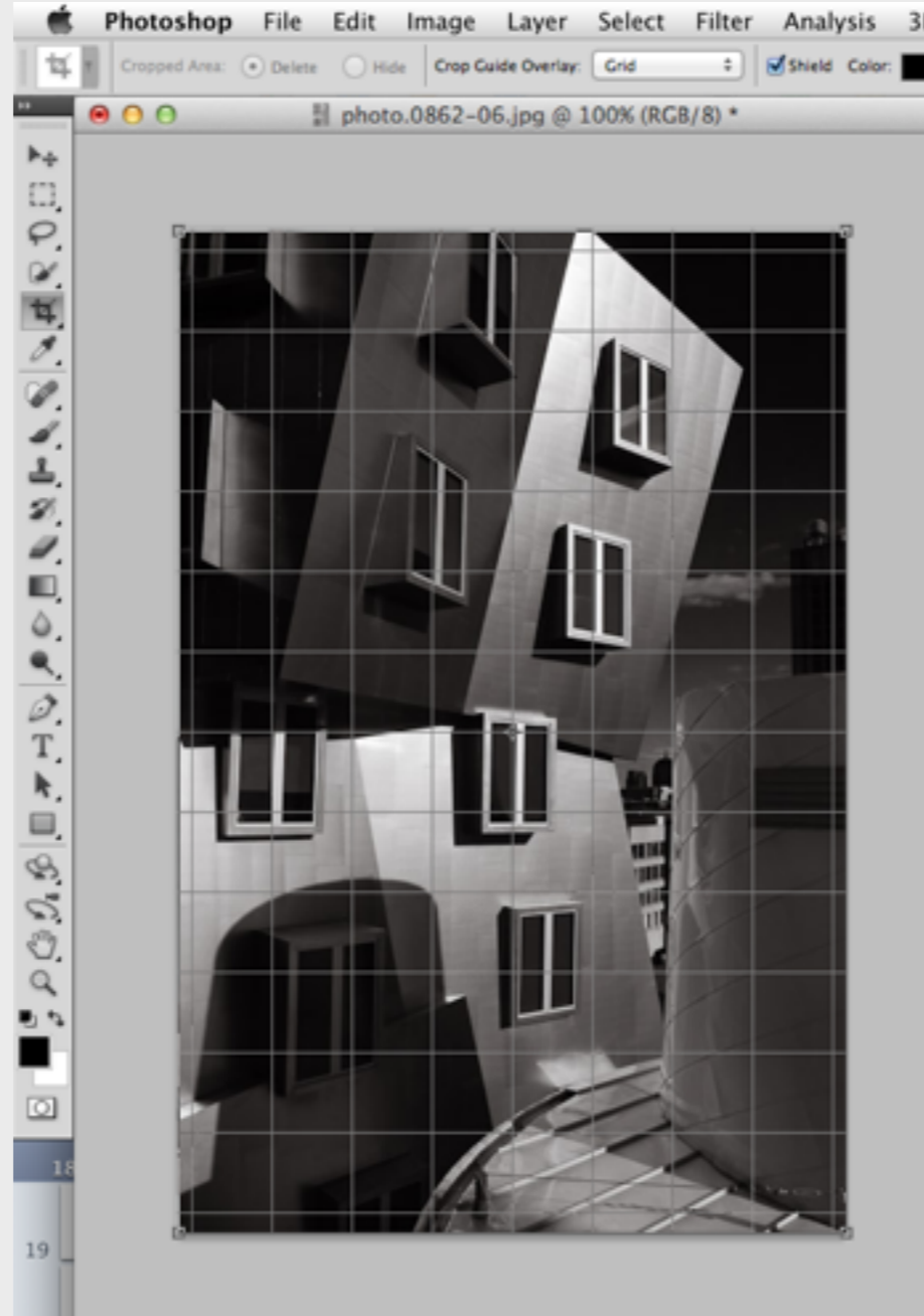

cropping the whole image

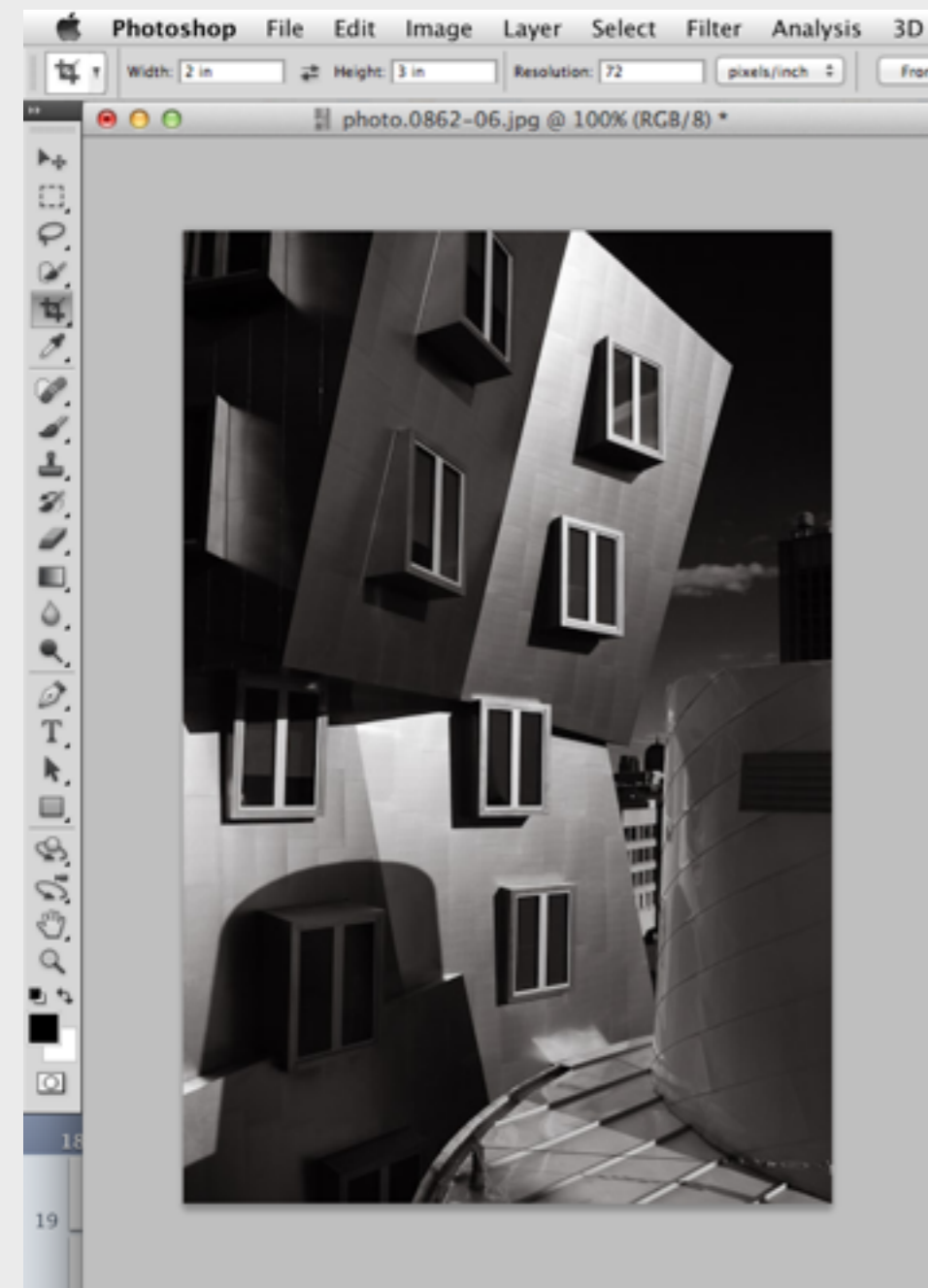

cropping the whole image

Resolution: 72



it's all about the concepts



Acrobat
text box
object
document text



Photoshop
channel
layer
mask



Lightroom
action
treatment
effect

it's all about the concepts

Adobe Acrobat is a family of computer programs developed by Adobe Systems, designed to view, create, manipulate and manage files ... »

53% Hate Acrobat

Tweet 15

g +1

237 Negative Opinions out of 444

Acrobat
text box
object
document text

Adobe Photoshop is a graphics editing program developed and published by Adobe Systems Incorporated.

30% Hate Photoshop

Tweet 105

g +1

12,978 Negative Opinions out of 43,283

Photoshop
channel
layer
mask

Adobe Photoshop Lightroom is a photography software program developed by Adobe Systems for Mac OS X and Microsoft Windows, designed ... »

11% Hate Lightroom

Tweet 5

g +1

297 Negative Opinions out of 2,632

Lightroom
action
treatment
effect

incoherent
concepts, no clear
purpose

it's all about the concepts



Acrobat
text box
object
document text



Photoshop
channel
layer
mask



Lightroom
action
treatment
effect

incoherent
concepts, no clear
purpose

powerful concepts
with low level
purposes

it's all about the concepts



Acrobat
text box
object
document text

incoherent
concepts, no clear
purpose



Photoshop
channel
layer
mask

powerful concepts
with low level
purposes



Lightroom
action
treatment
effect

simple
concepts with
purposes aligned to
common tasks

all's well that ends well

all's well that ends well

acrobat 9
deeply troubled

all's well that ends well

acrobat 9

deeply troubled

acrobat 10

user interface tweaks

all's well that ends well

acrobat 9

deeply troubled

acrobat 10

user interface tweaks

acrobat 11

conceptual reworking

acrobat (version 09)

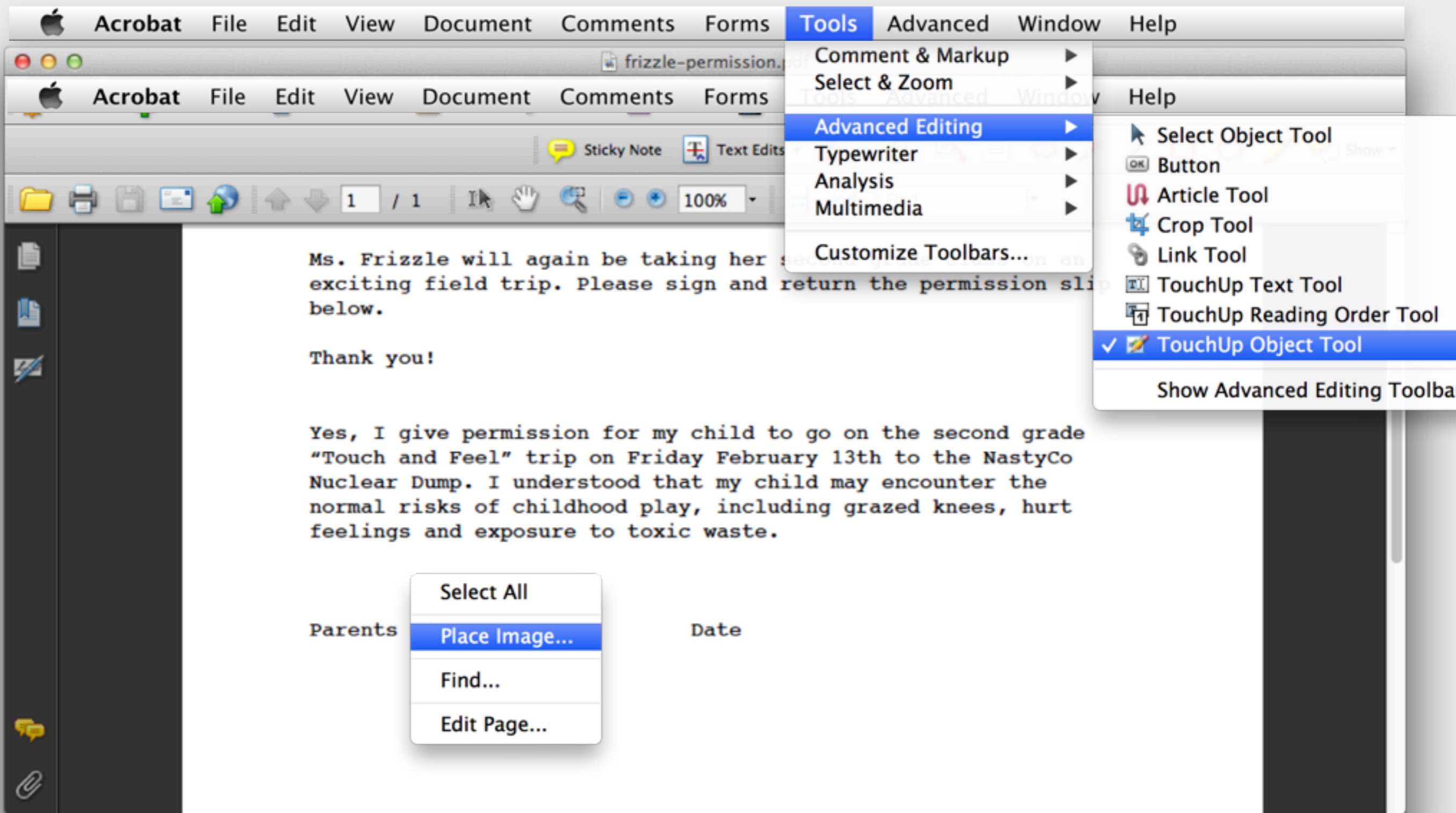

hard to discern any compelling concepts

acrobat (version 09)

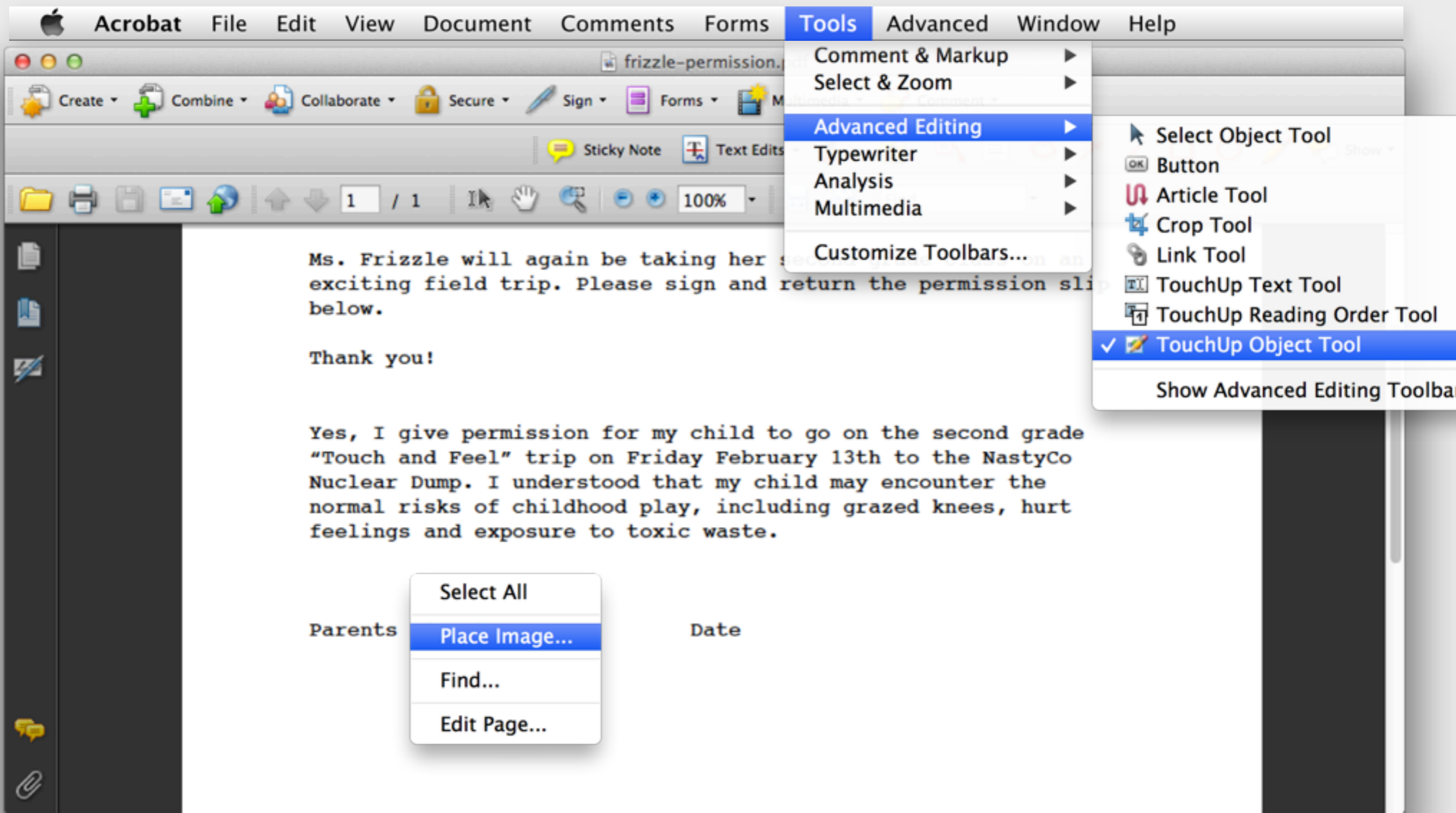

hard to discern any compelling concepts

acrobat (version 10)

acrobat (version 10)

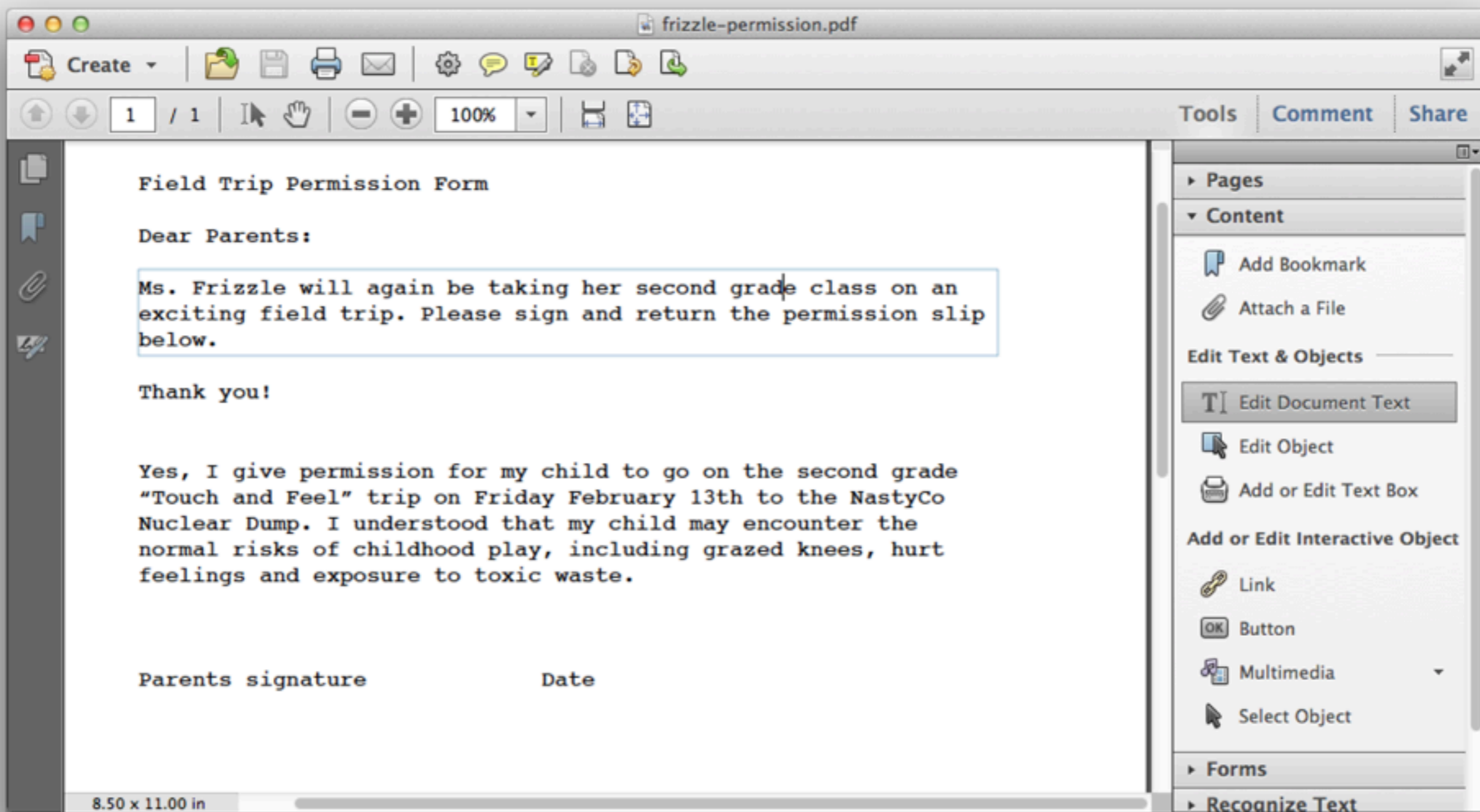

acrobat (version 10)

frizzle-permission.pdf

Create |

1 / 1 | 100% |

Tools | Comment | Share

Pages

Content

- Add Bookmark
- Attach a File
- Edit Text & Objects
 - Edit Document Text
 - Edit Object**
 - Add or Edit Text Box
- Add or Edit Interactive Object
 - Link
 - Button
 - Multimedia
 - Select Object
- Forms
- Recognize Text

Field Trip Permission Form

Dear Parents:

Ms. Frizzle will again be taking her second grade class on an exciting field trip. Please sign and return the permission slip below.

Thank you!

Yes, I give permission for my child to go on the second grade "Touch and Feel" trip on Friday February 13th to the NastyCo Nuclear Dump. I understood that my child may encounter the normal risks of childhood play, including grazed knees, hurt feelings and exposure to toxic waste.

Parents signature Date

8.50 x 11.00 in

acrobat (version 11)

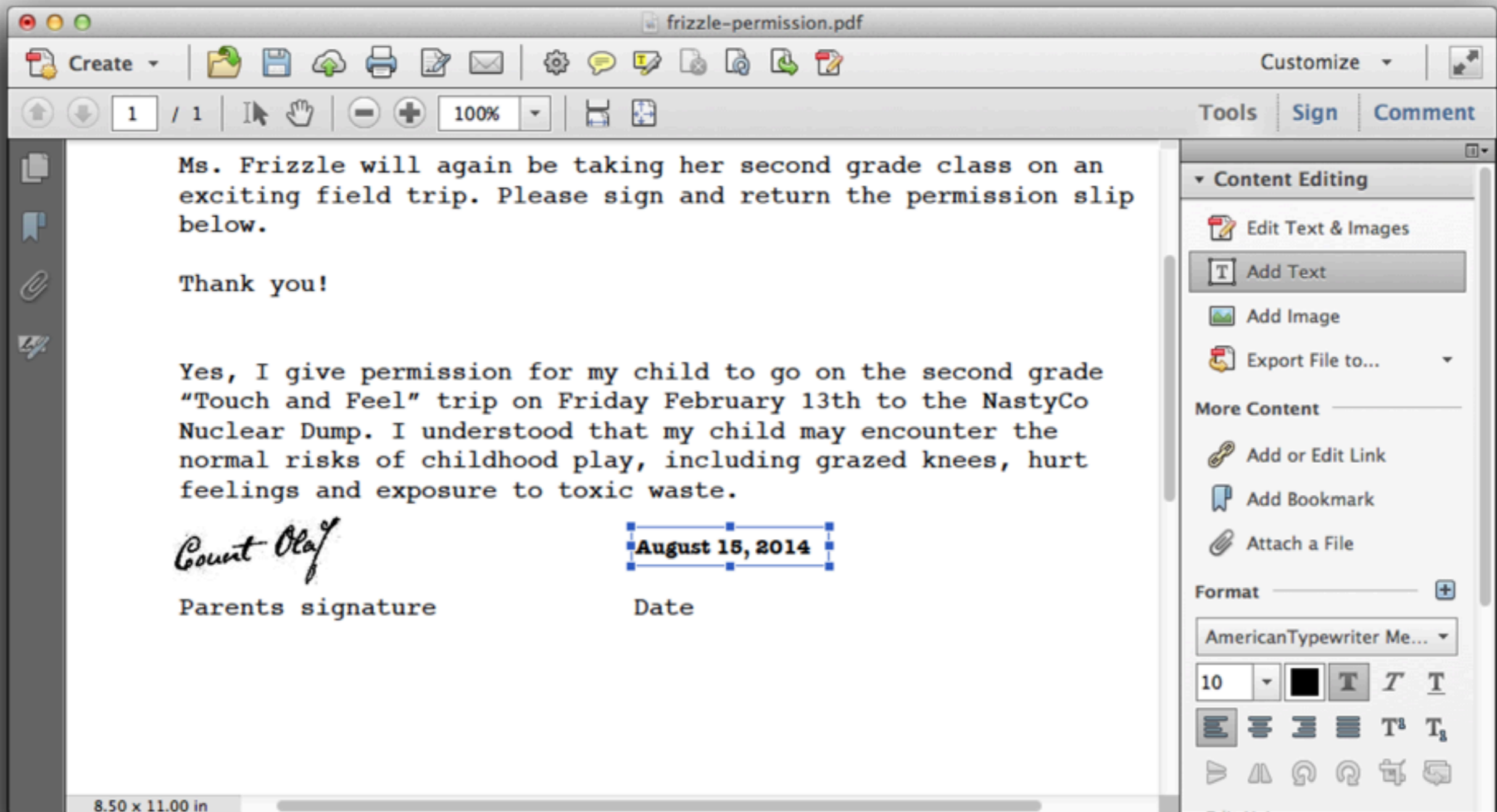

conceptual reworking: now just *text*

designing
the user

designing the user too

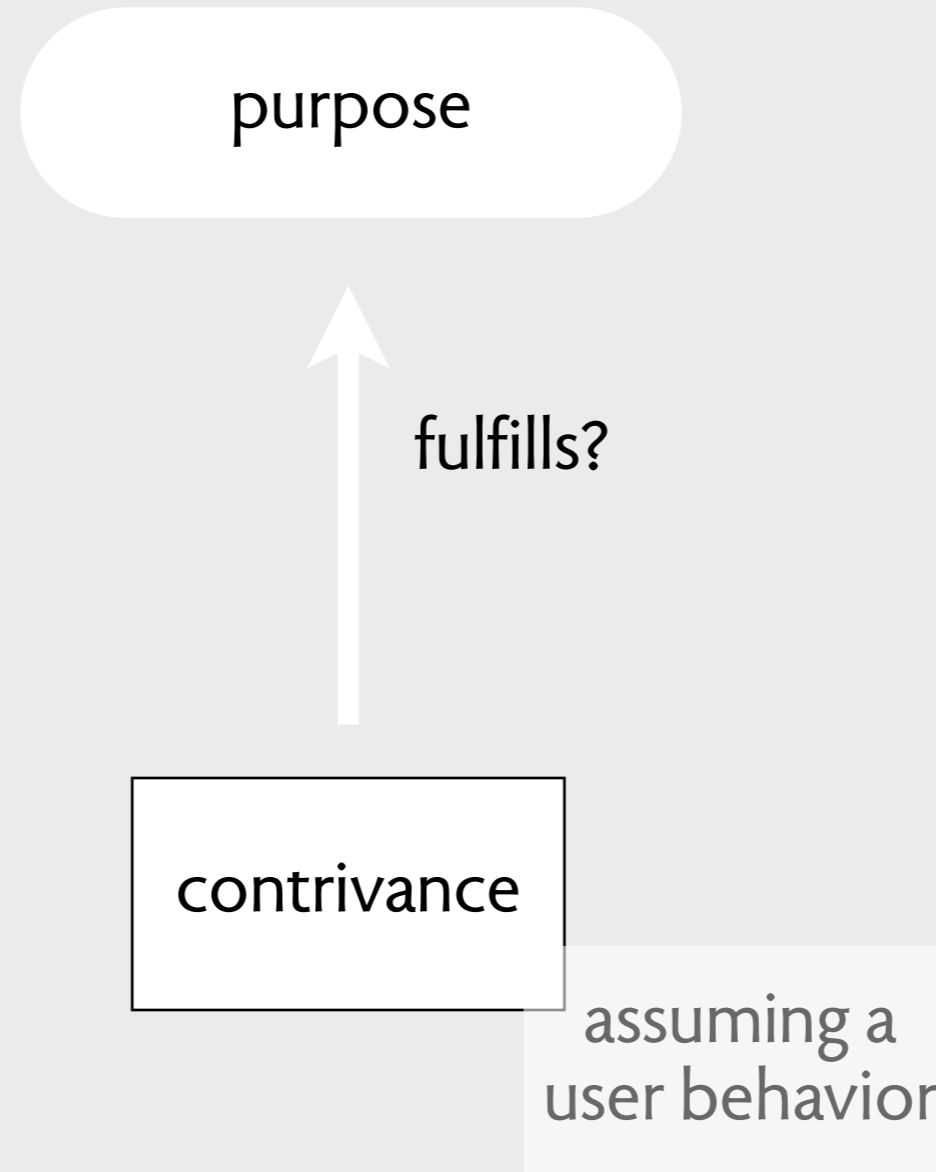

example: magnetic paint

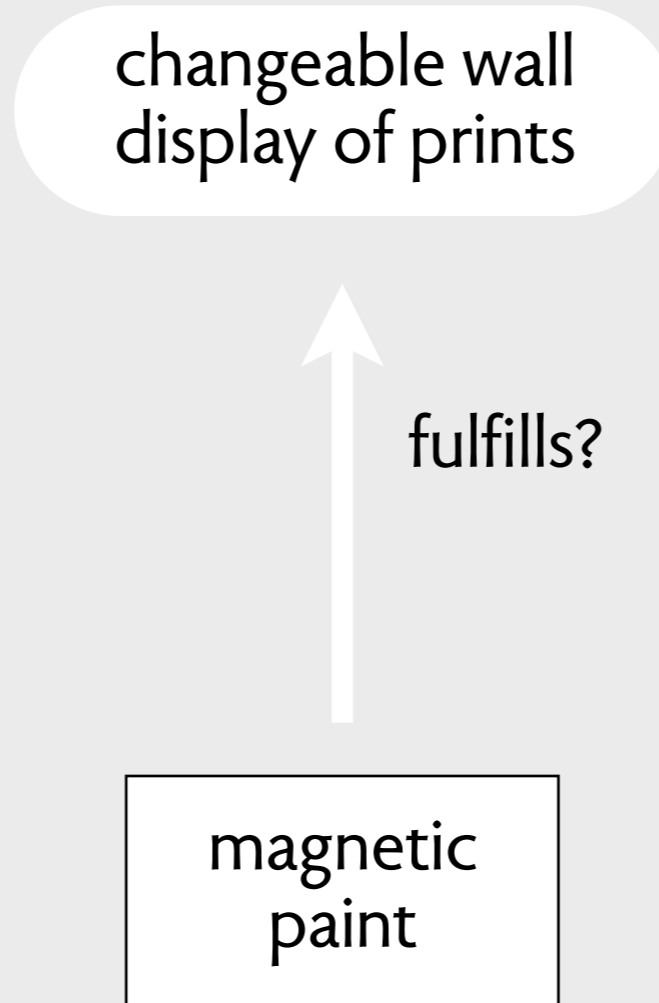

example: magnetic paint

changeable wall
display of prints



fulfills?

magnetic
paint

six coats

example: magnetic paint

changeable wall
display of prints



fulfills?

magnetic
paint

six coats

neodymium
magnets

example: aligning elements

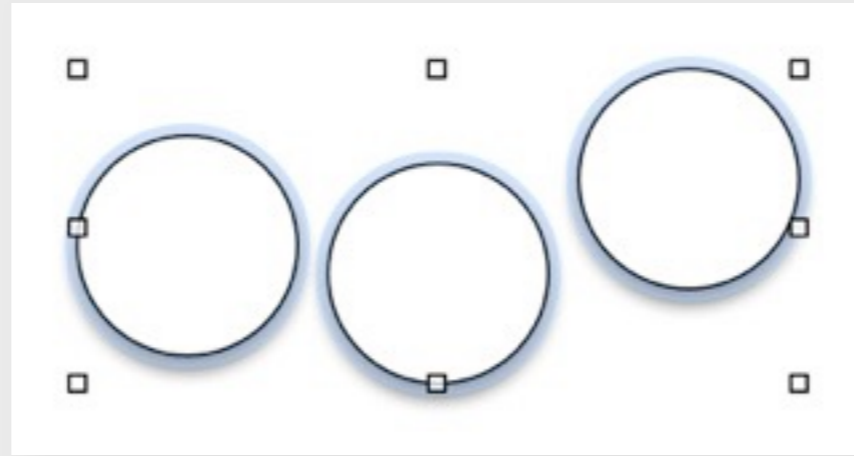

purpose: help align objects

example: aligning elements

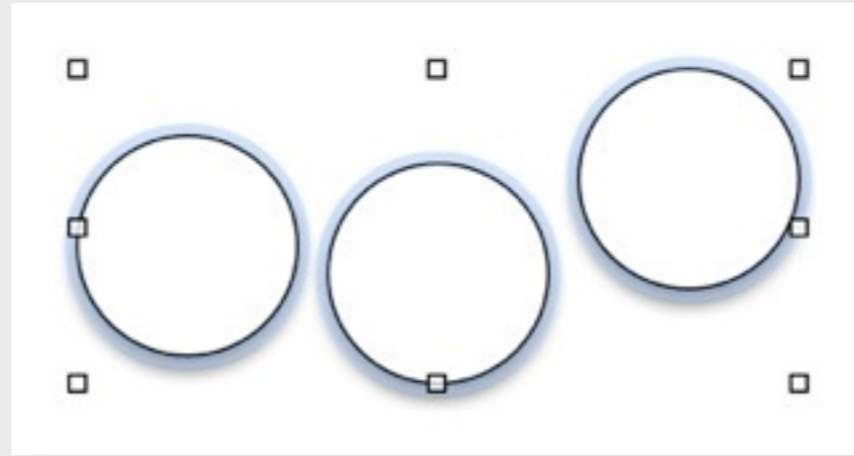

purpose: help align objects

Align Left Edges

Align Right Edges

Align Top Edges

Align Bottom Edges

Align Vertical Centers

Align Horizontal Centers

Make Centered Row

Make Centered Column

a contrivance: autoalign

example: aligning elements

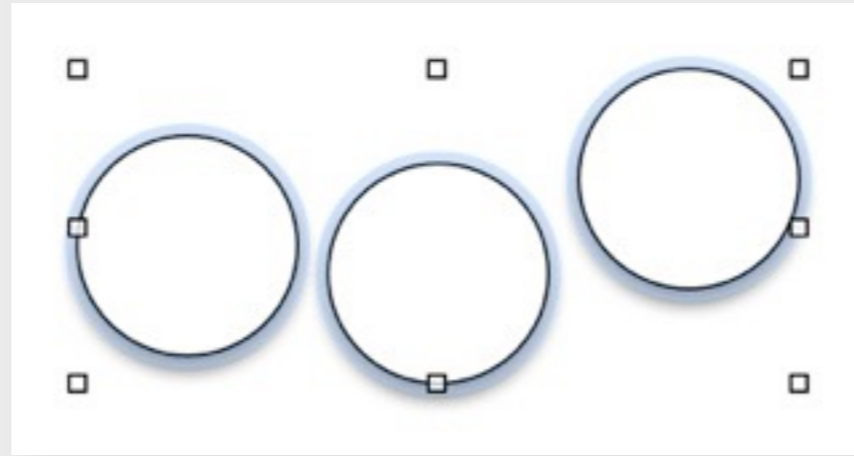

purpose: help align objects

- Align Left Edges
- Align Right Edges
- Align Top Edges
- Align Bottom Edges
- Align Vertical Centers
- Align Horizontal Centers
- Make Centered Row
- Make Centered Column

a contrivance: autoalign

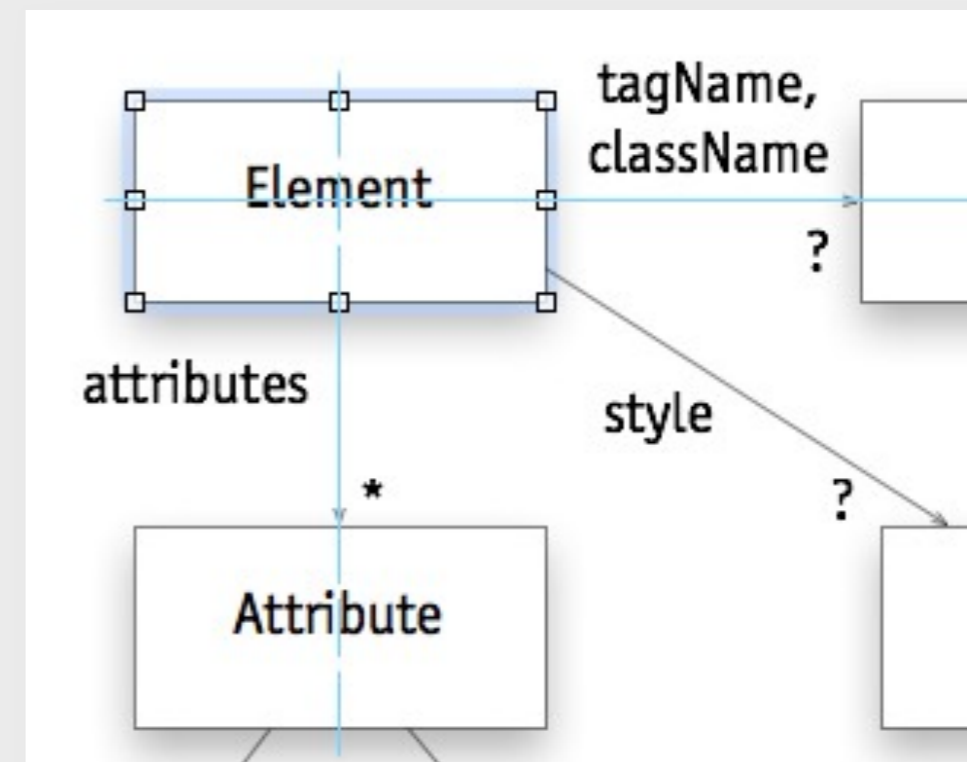

a better contrivance: snap align

example: auto align

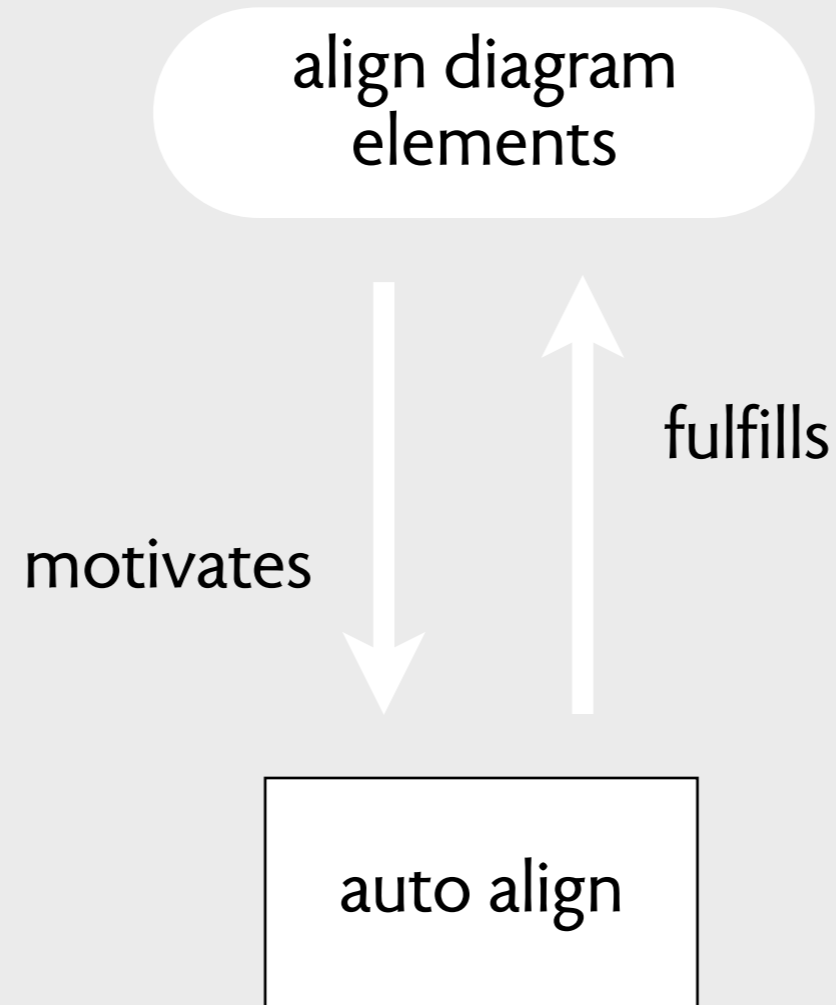

example: auto align

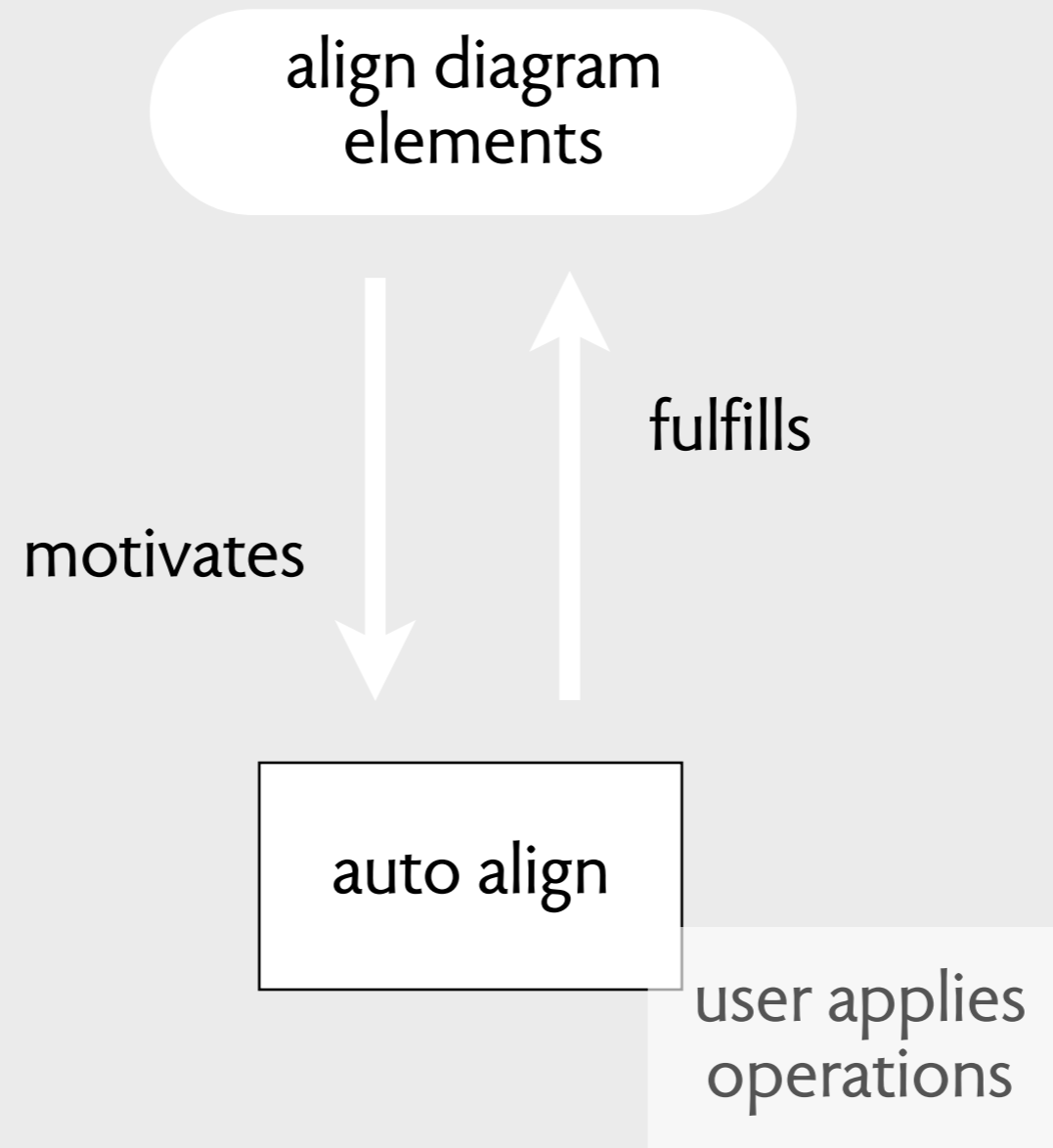

example: snap align

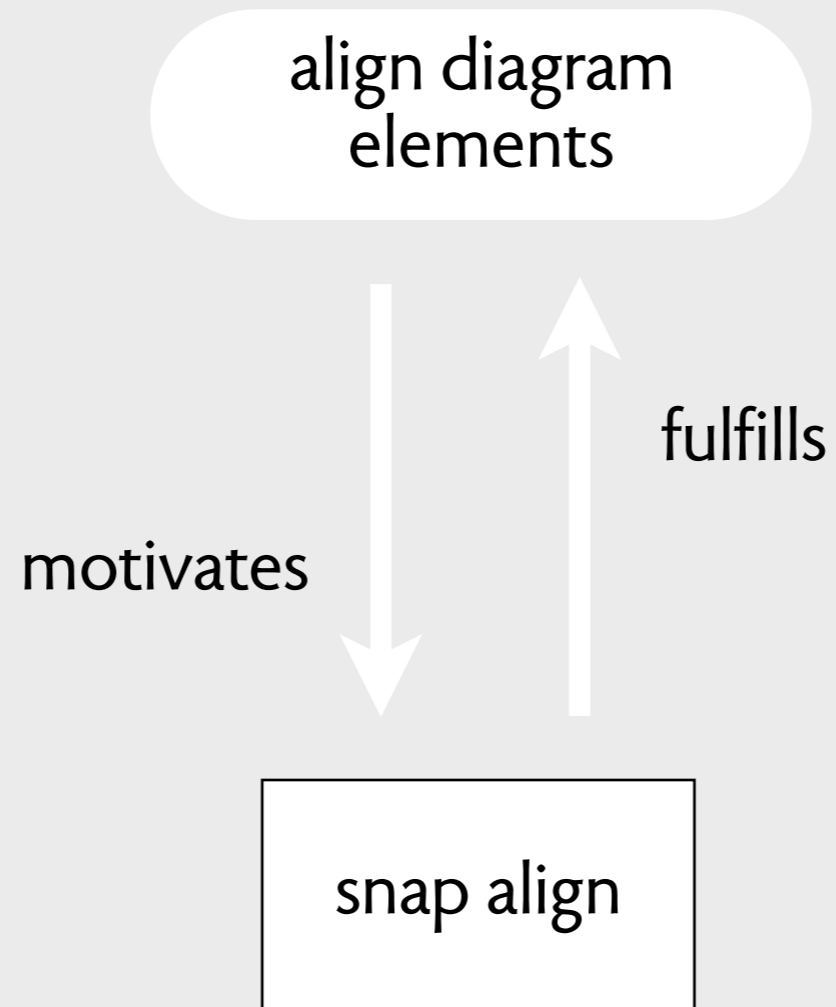

example: snap align

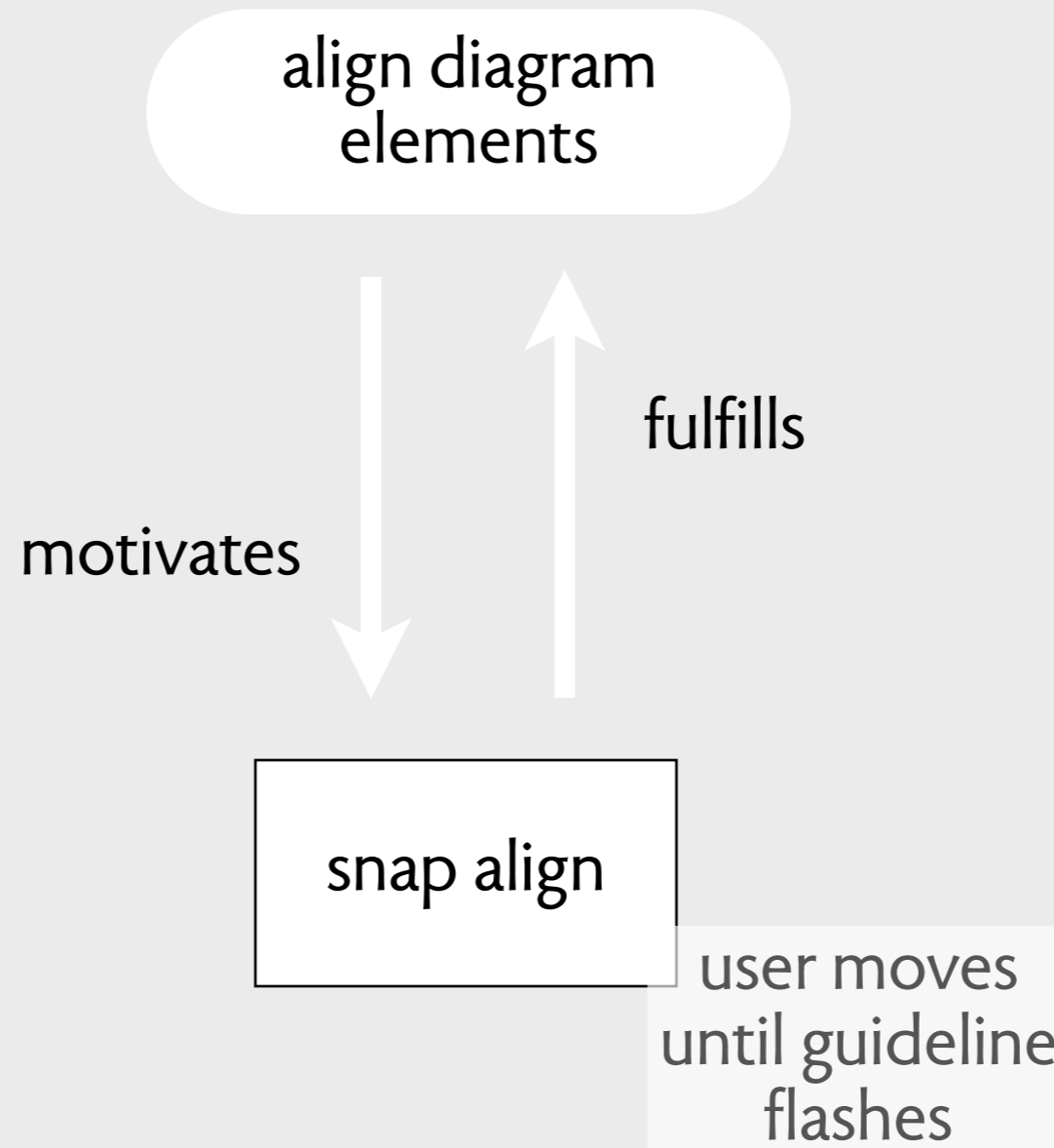

in conventional software terms

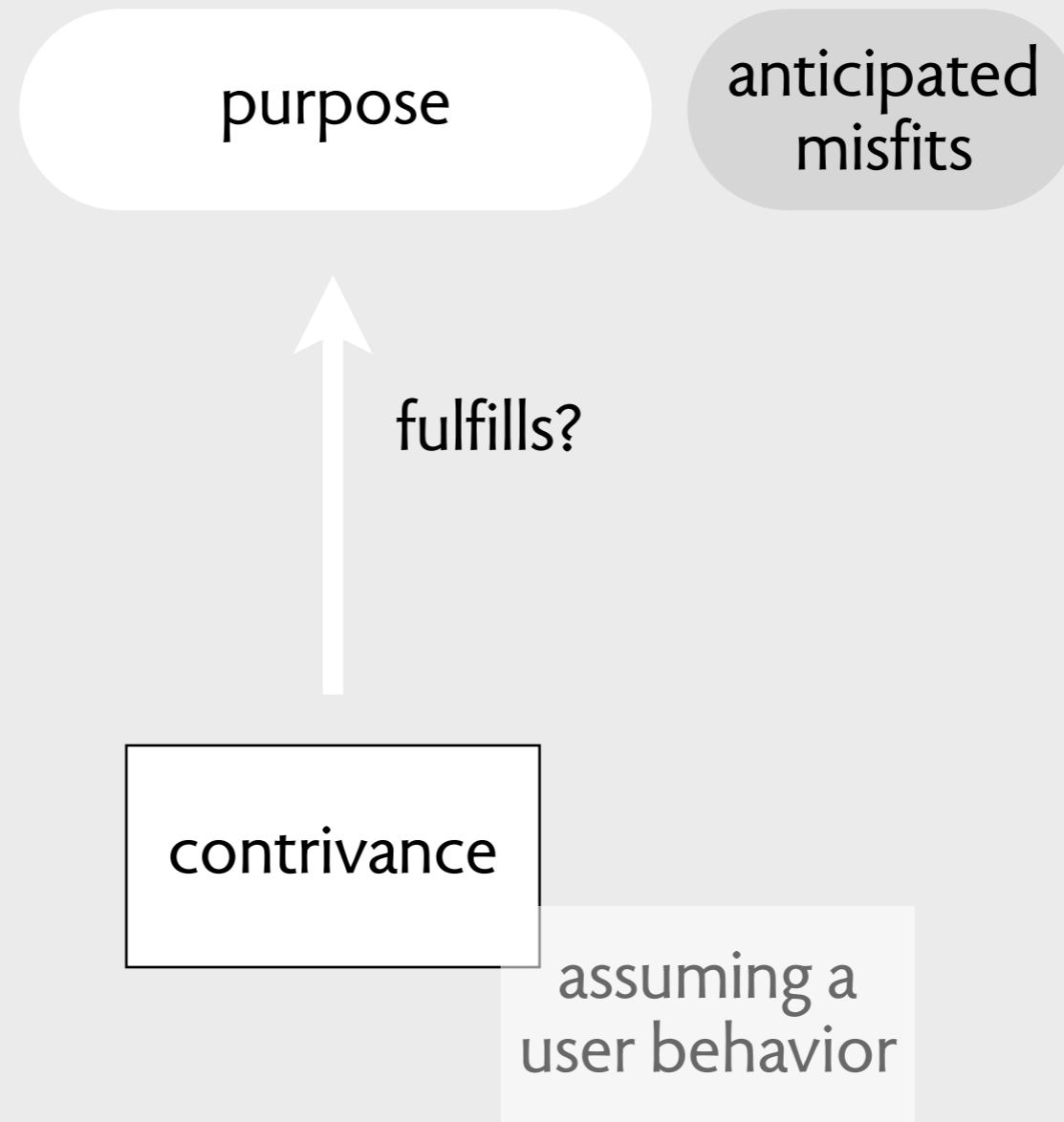

in conventional software terms

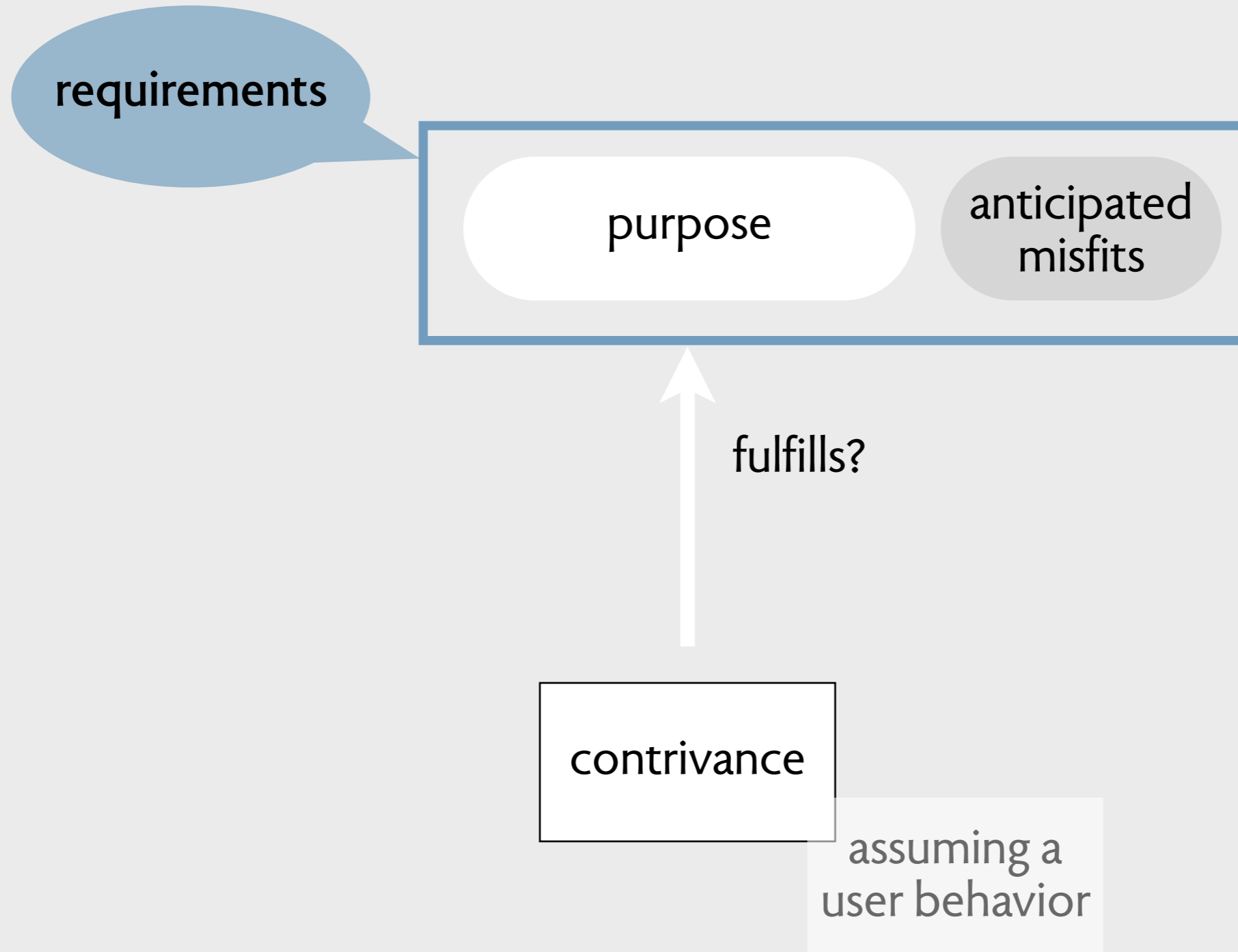

in conventional software terms

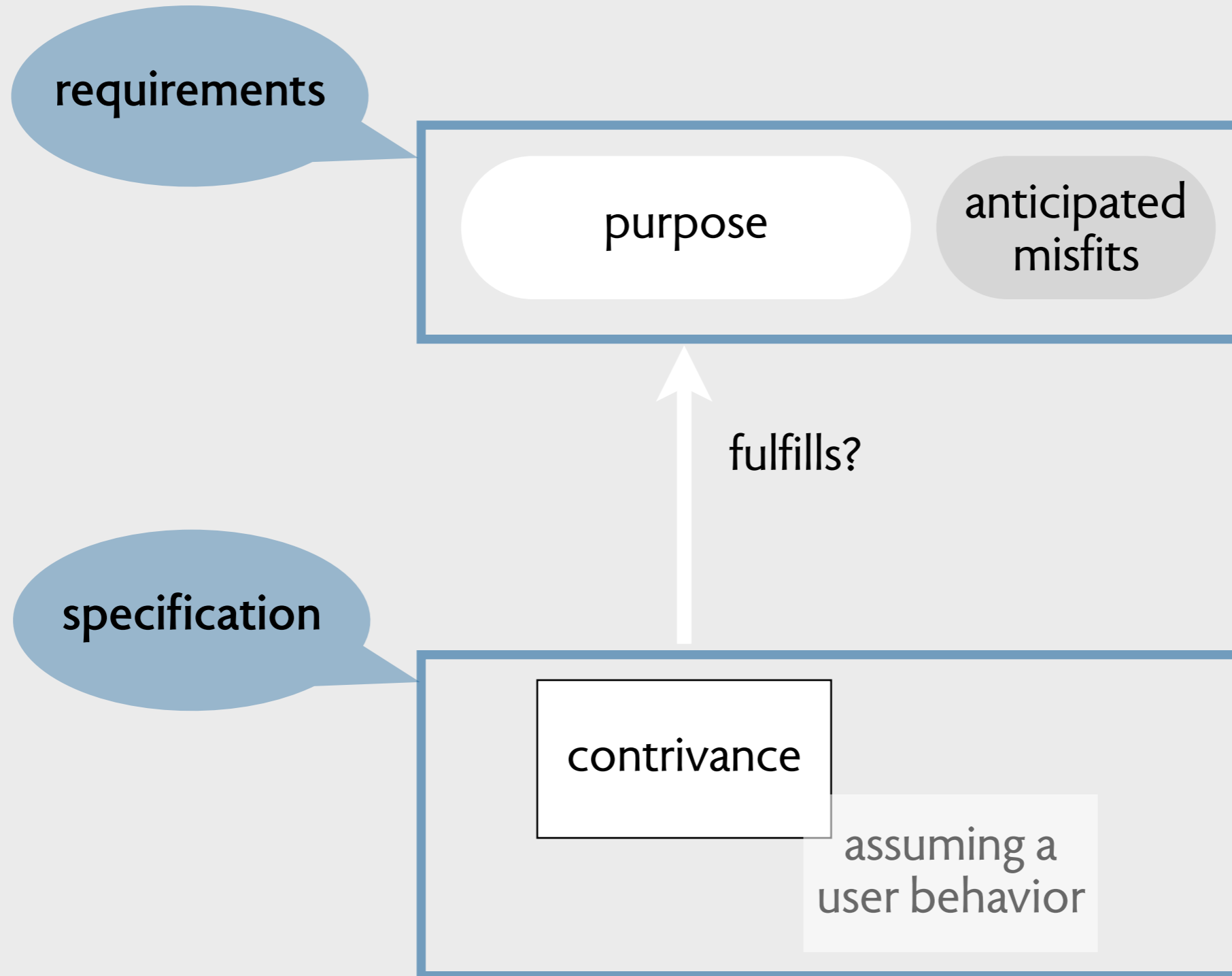

abstract
affordances

Simple Alarm Clock

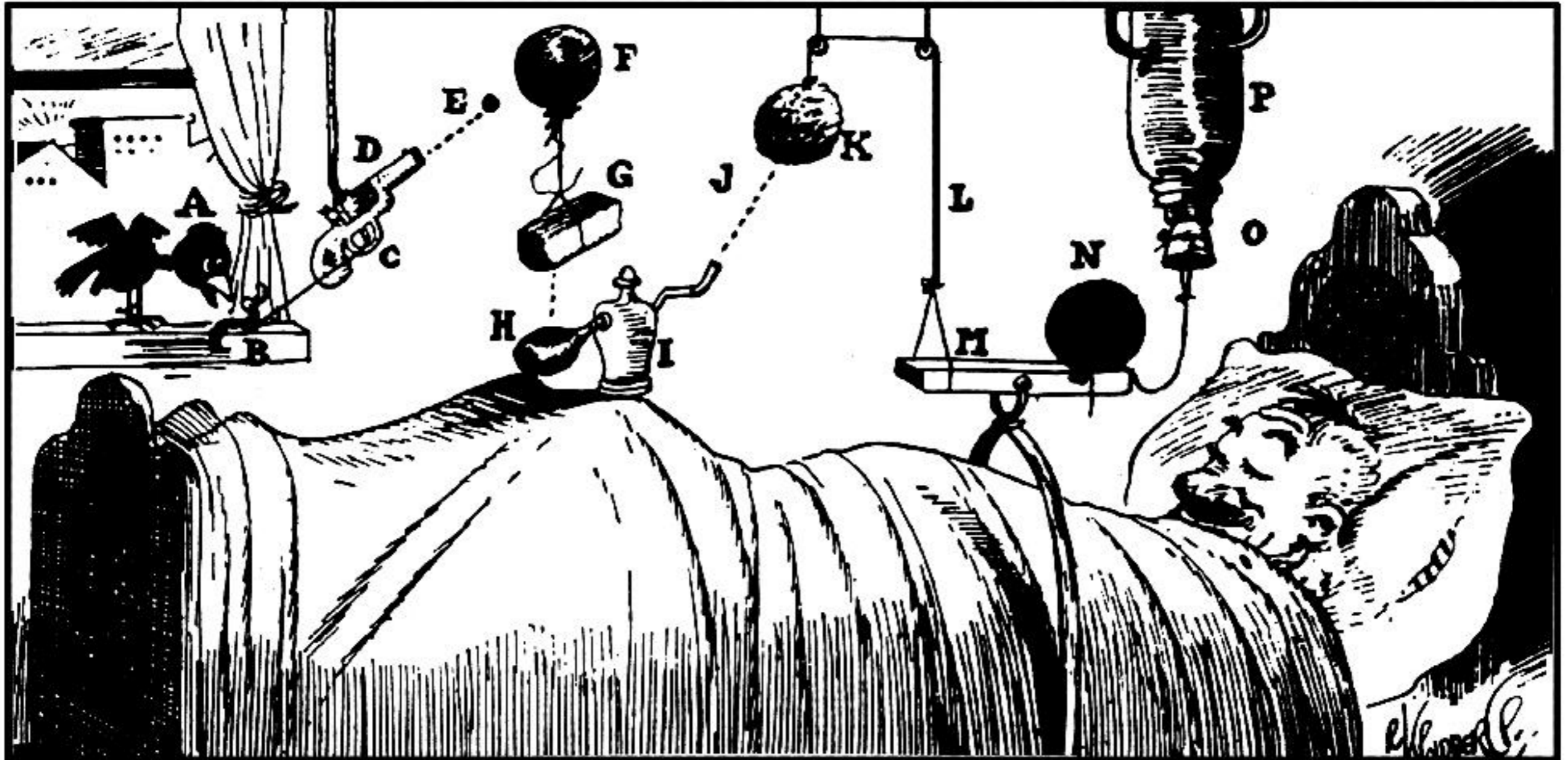

The early bird (A) arrives and catches worm (B), pulling string (C) and shooting off pistol (D). Bullet (E) busts balloon (F), dropping brick (G) on bulb (H) of atomizer (I) and shooting perfume (J) on sponge (K)—As sponge gains in weight, it lowers itself and pulls string (L), raising end of board

(M)—Cannon ball (N) drops on nose of sleeping gentleman—String tied to cannon ball releases cork (O) of vacuum bottle (P) and ice water falls on sleeper's face to assist the cannon ball in its good work.

New Alarm

Time

Alarm

Alarm Time:

6:00 AM



Alarm Date:

One time alarm

4/16/2013



Repeating alarm

Sun	Mon	Tue	Wed	Thu	Fri	Sat
-----	-----	-----	-----	-----	-----	-----

Enable Alarm

Delete

Cancel

OK

New Alarm



Invalid alarm time

Please select a date and time in the future.

6:00 AM

OK

Alarm Date:

One time alarm

4/16/2013

Repeating alarm

Sun	Mon	Tue	Wed	Thu	Fri	Sat
-----	-----	-----	-----	-----	-----	-----

Enable Alarm

Delete

Cancel

OK

New Alarm

Time

Alarm

Alarm Time:

6:00 AM



Alarm Date:

One time alarm

4/17/2013



Repeating alarm

Sun	Mon	Tue	Wed	Thu	Fri	Sat
-----	-----	-----	-----	-----	-----	-----

Enable Alarm

Delete

Cancel

OK

New Alarm

Time Alarm

Alarm Time: 6:00 AM 

Alarm Date:

One time alarm

4/17/2013 

Repeating alarm

Sun Mon Tue Wed Thu Fri Sat

Enable Alarm

Delete

Cancel

OK

✓ 06:00 AM Tomorrow

New Alarm...

New Timer...

New Stopwatch...

About Alarm Clock 2

Check for updates...

Preferences...

Quit



Edit

Alarm



4:30 AM

Mexico trip



5:45 AM

Exercise morning



6:00 AM

Non-exercise morning



6:40 AM

Alarm



7:00 AM

Camping



World Clock



Alarm



Stopwatch



Timer



Donald Norman

THE DESIGN OF EVERYDAY THINGS

previously published as
THE PSYCHOLOGY
OF EVERYDAY THINGS

D O N A L D A . N O R M A N



Donald Norman

James Gibson (1977): "action possibilities" latent in environment



James Gibson (1977): "action possibilities" latent in environment

Donald Norman (1988): action possibilities that are perceivable



a door with good affordances



a door with good affordances



a door with good affordances



“norman doors”

“norman doors”



push or pull?

“norman doors”



push or pull?



door with user manual

“norman doors”



push or pull?



door with user manual



conflicting instructions



Who Is in These Photos?

To tag your friends, review the suggested names and click Save Tags at the bottom of this page. If a name is missing or incorrect, list a new name and press Enter.
Remember: If someone doesn't like a photo, they can untag themselves or ask you to take it down.

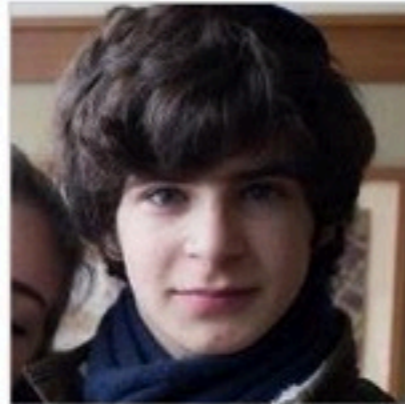

Who is this?

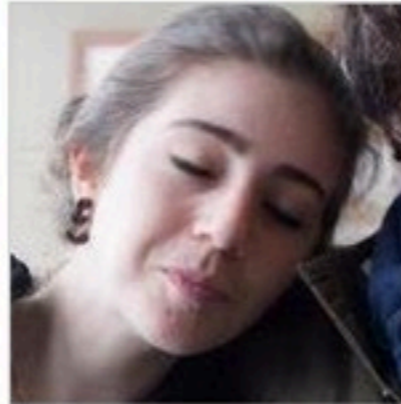

Who is this?

[Skip Tagging Friends](#)

[Save Tags](#)

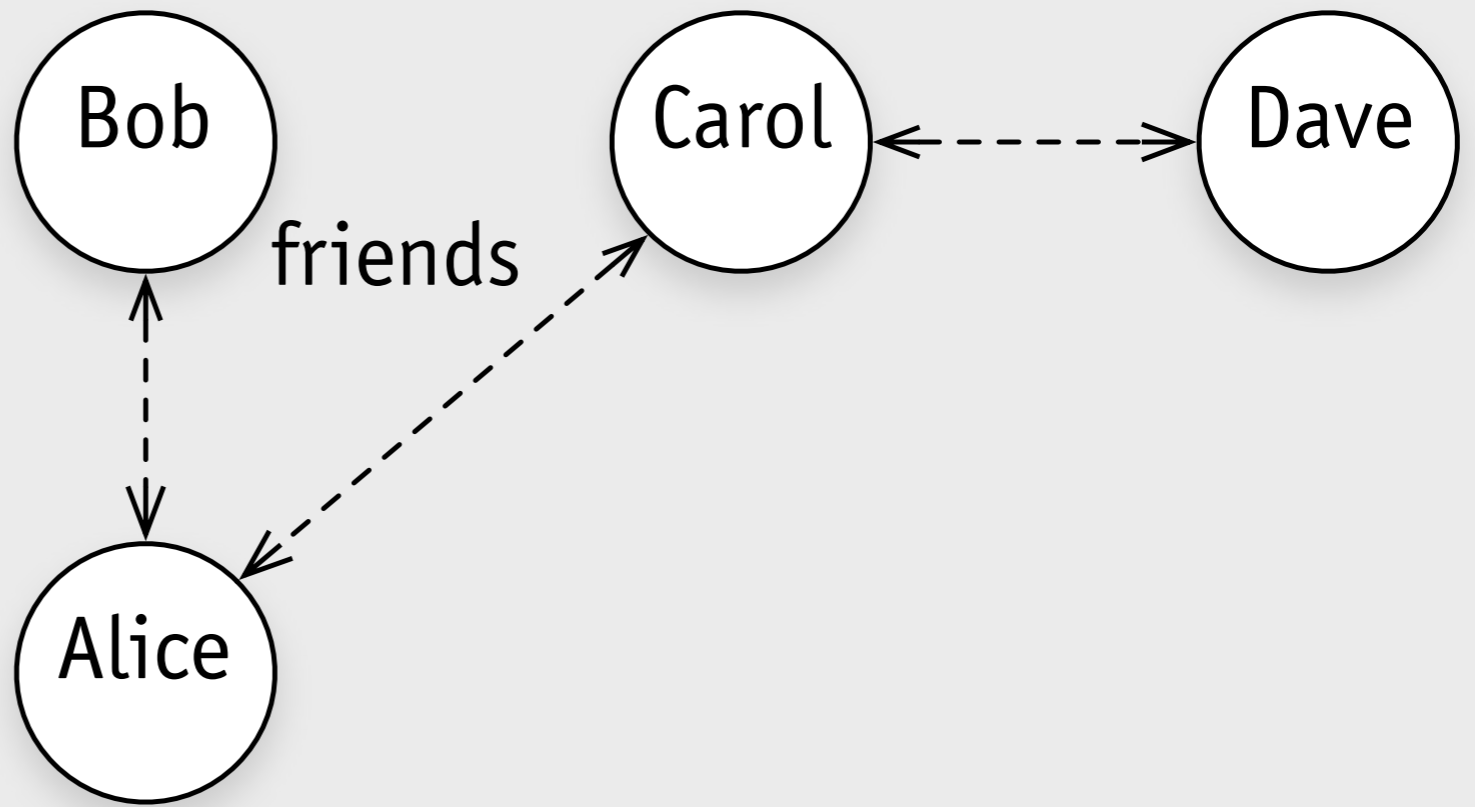

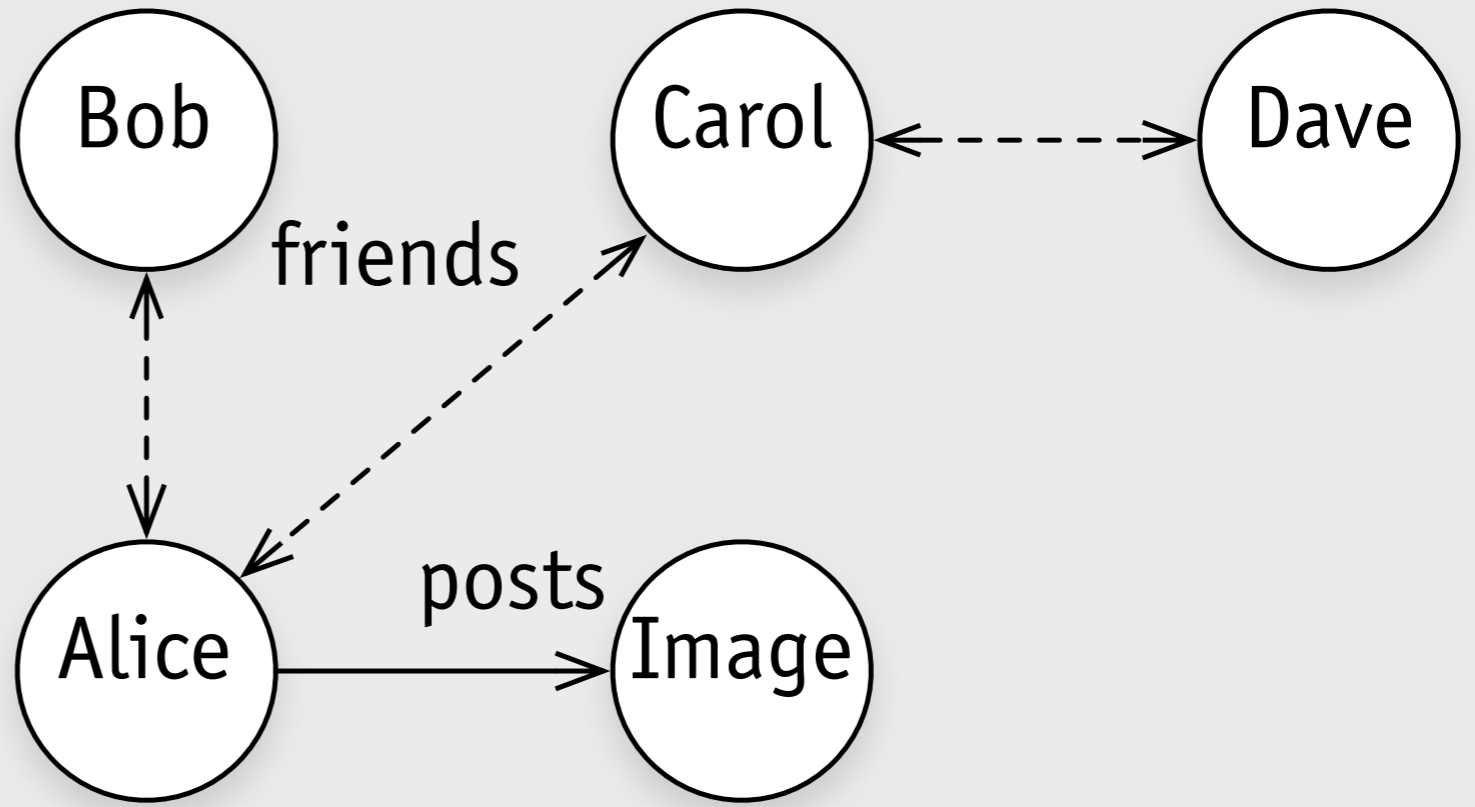

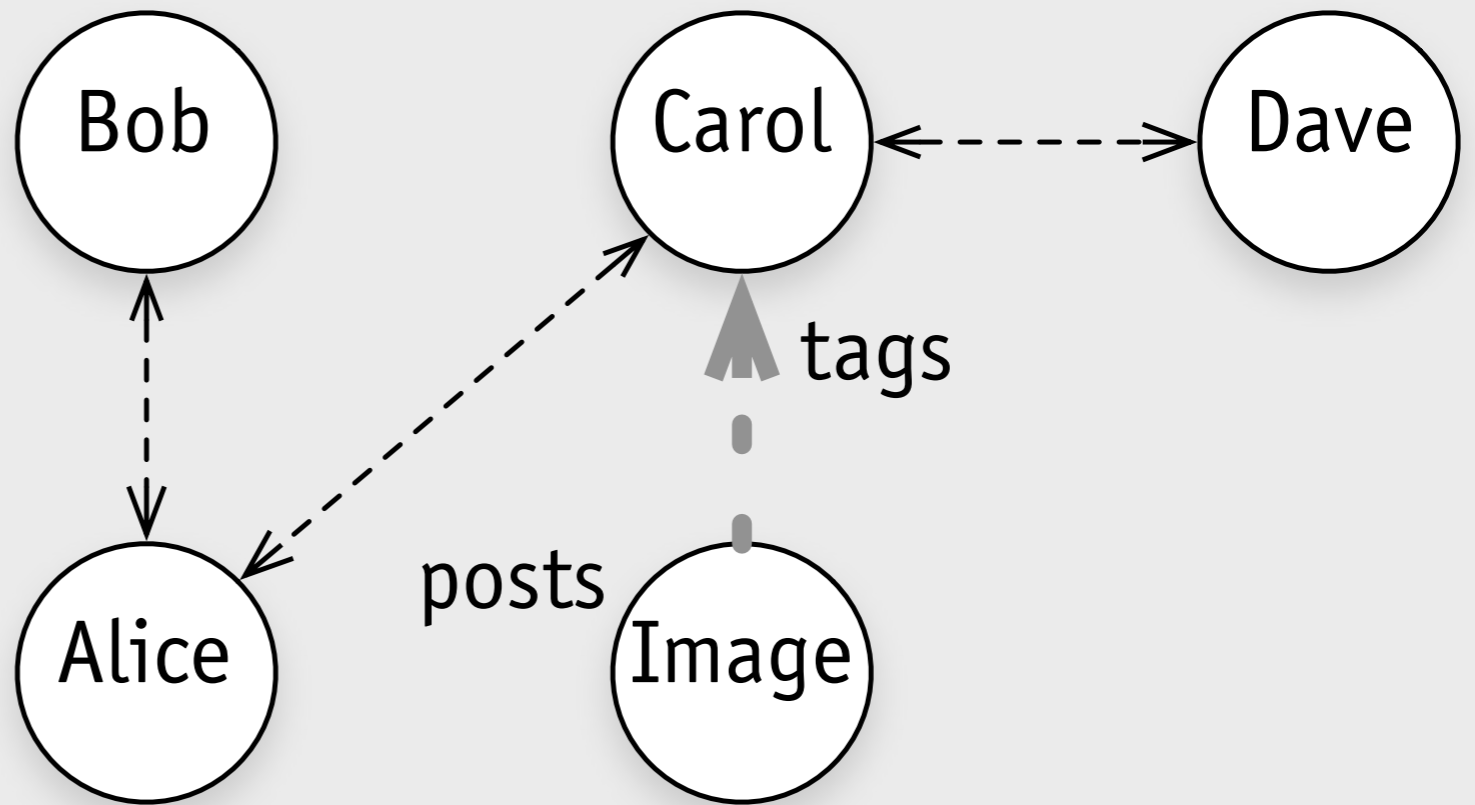

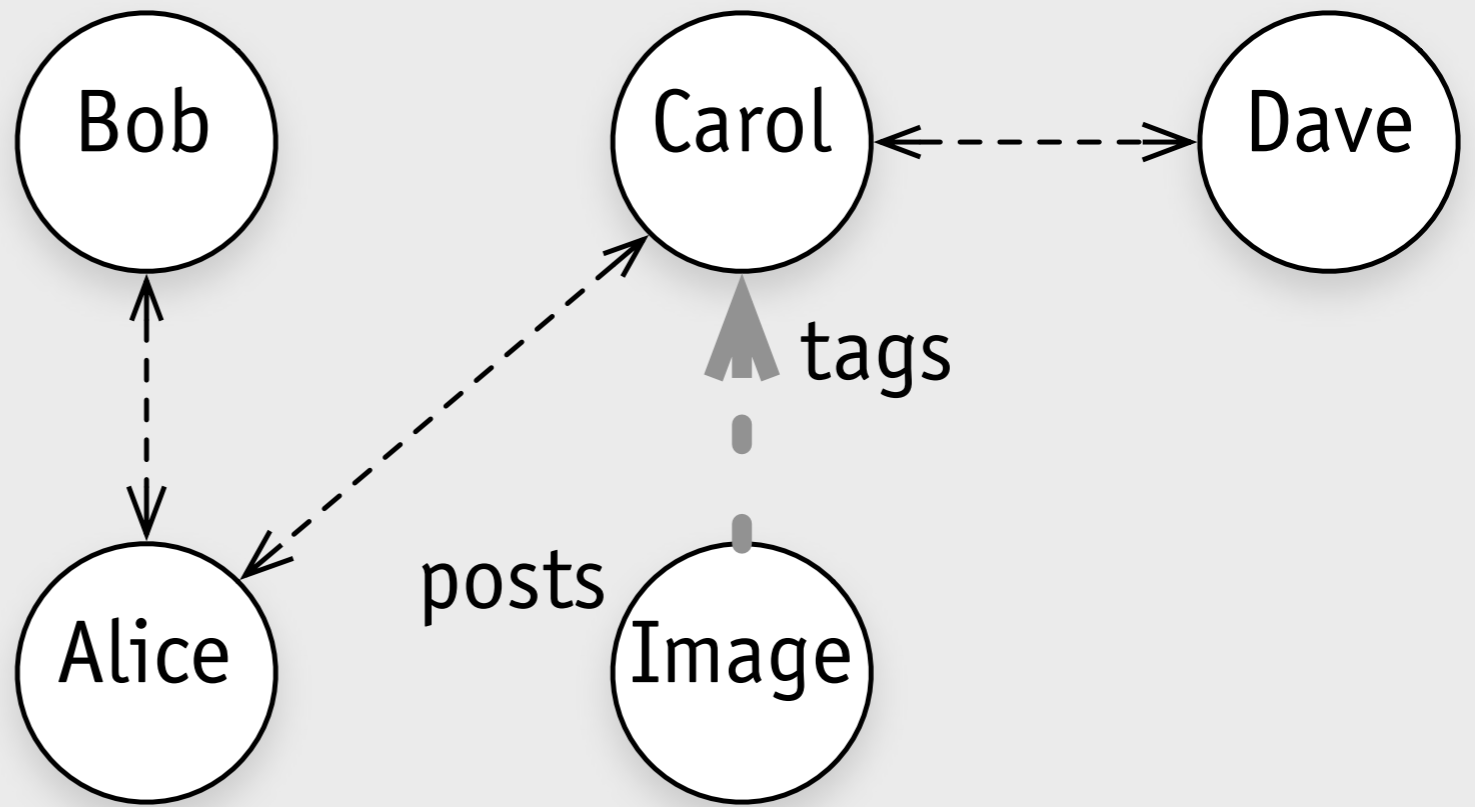

who can see the image?

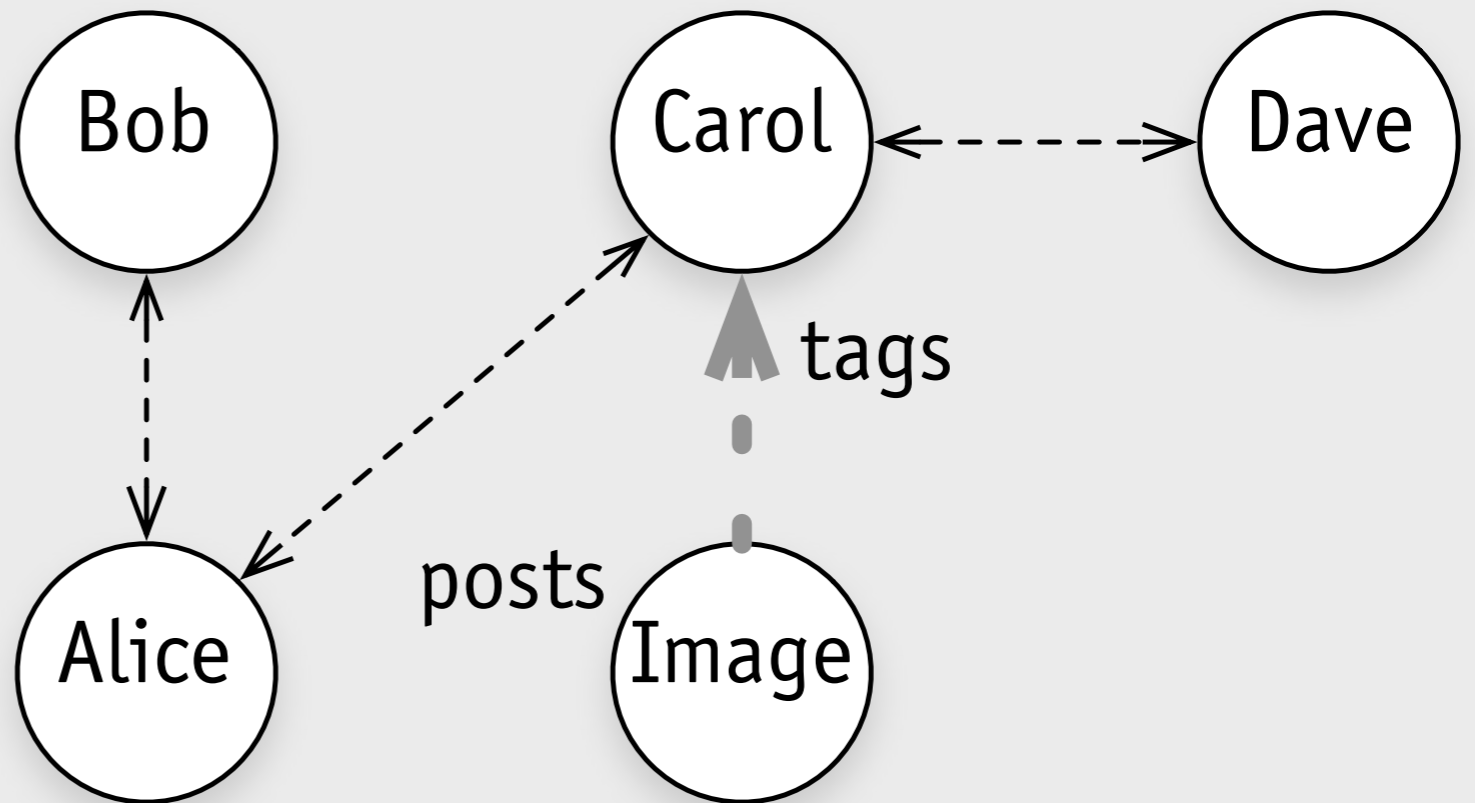

who can see the image?

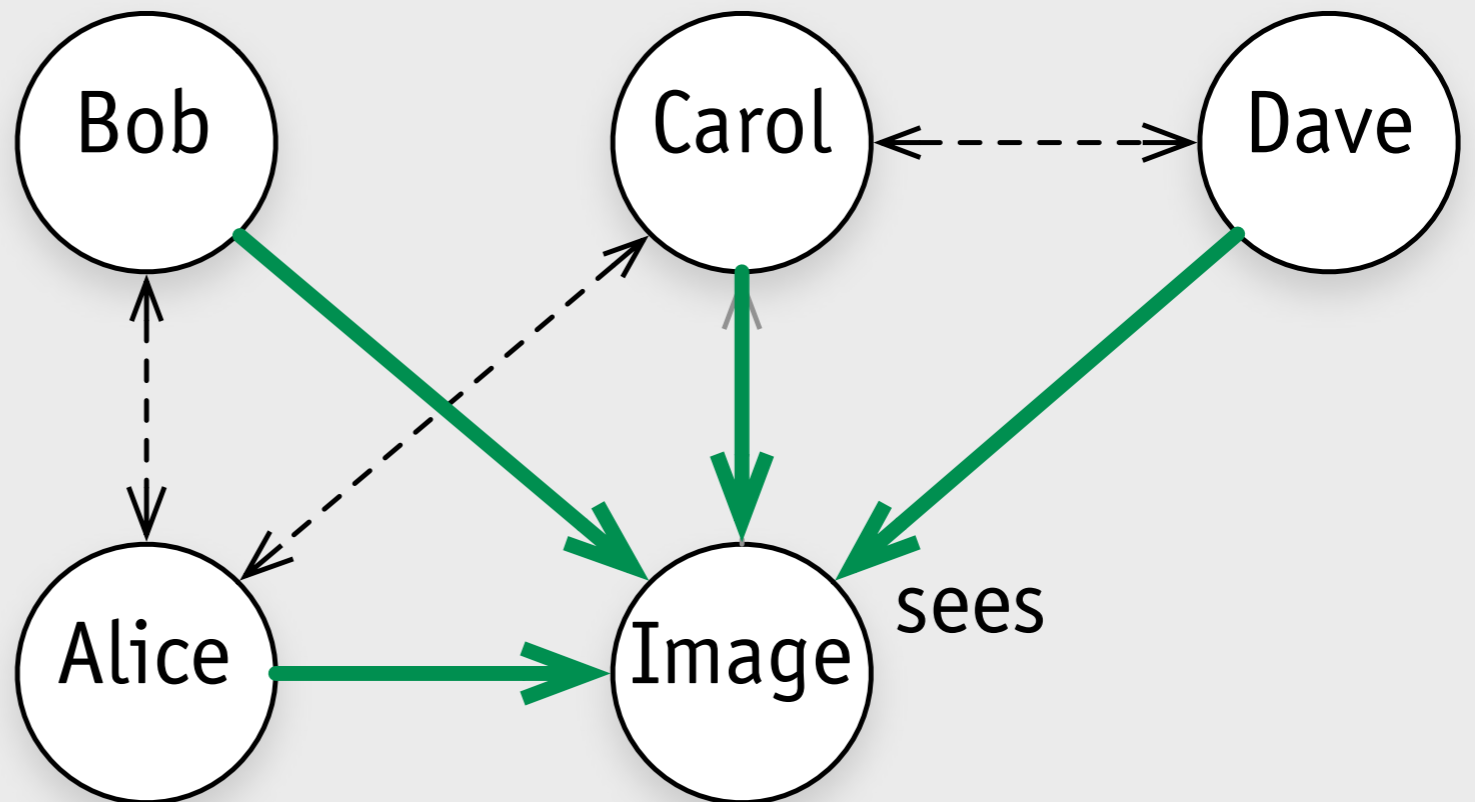

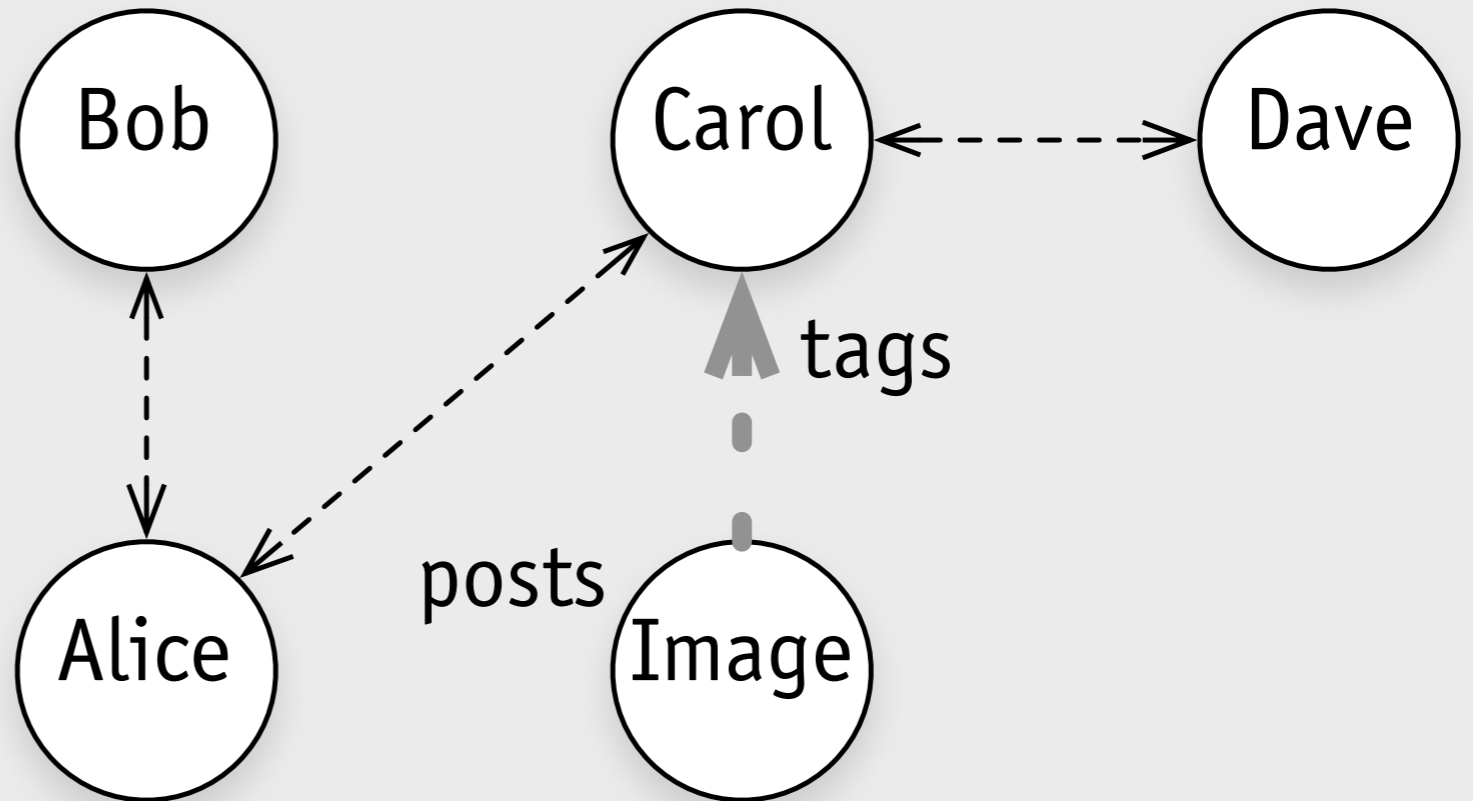
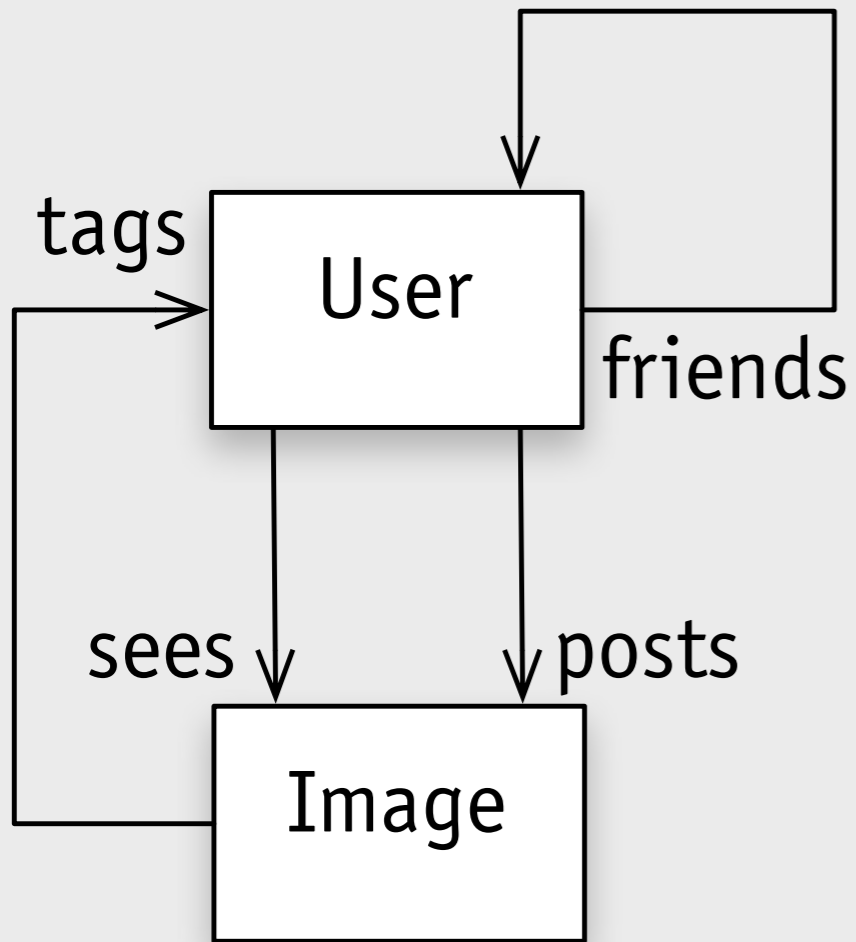

who can see the image?

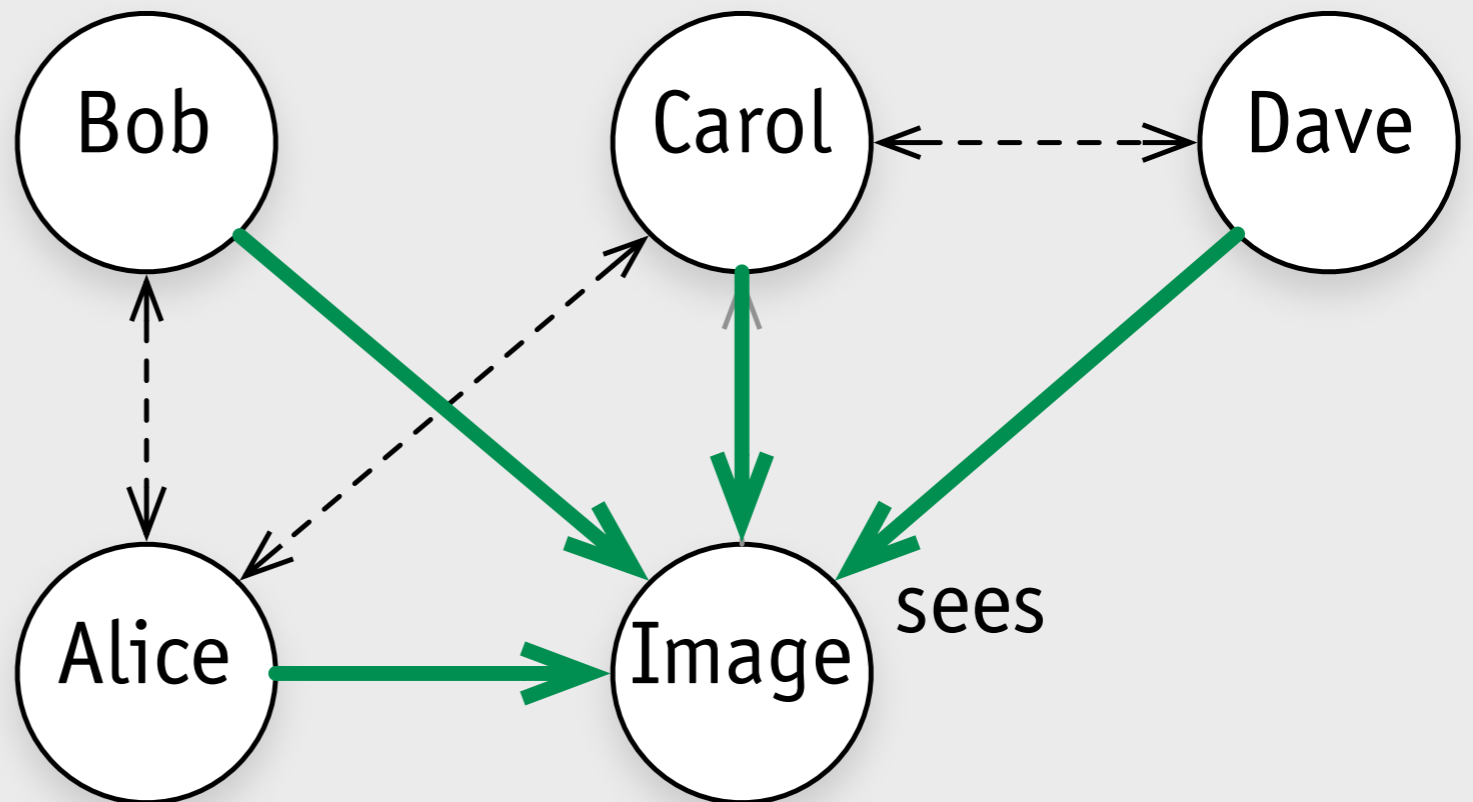

what facebook says

When someone adds a tag to a photo or other post I shared, who can see it?

When someone adds a tag to something you shared, it's visible to:

- The audience you chose for the post or photo
- The person tagged in the post and their friends

what facebook says

When someone adds a tag to a photo or other post I shared, who can see it?

When someone adds a tag to something you shared, it's visible to:

- The audience you chose for the post or photo
- The person tagged in the post and their friends

as a textual constraint in Alloy:

all i: Image | sees.i = (posts.i).friends + (i.tags).friends

what facebook should say

When a psychopathic stranger takes a photo of me at a party and tags me, who can see it?

When someone adds a tag to something you didn't share, it's visible to:

- All of their friends and fellow psychopaths
- All of your future employers, boyfriends, girlfriends and in-laws

lesson

lesson

for physical designs

effects are clear, if hard to predict
affordances connect actions to effects

lesson

for physical designs

effects are clear, if hard to predict
affordances connect actions to effects

for software designs

effects are often not clear
affordances become 'abstract'

lesson

for physical designs

effects are clear, if hard to predict
affordances connect actions to effects

for software designs

effects are often not clear
affordances become 'abstract'

so we need to

convey to users effects of actions
challenge: effects are indirect

design
thinking

process



process



optimize organization & task structure

Taylor (1880s), Toyota JIT (1980s), CMM (1990s), agile (2000s)

“new” activities

“new” activities



brainstorming

“new” activities



brainstorming



user studies

“new” activities



brainstorming



user studies



prototypes

style

style



Dieter Rams, 1958
pocket transistor radio T3

style



Dieter Rams, 1958
pocket transistor radio T3



Henry Hobson Richardson, 1877
Trinity Church, Boston

style



Dieter Rams, 1958
pocket transistor radio T3



Henry Hobson Richardson, 1877
Trinity Church, Boston



Leica, 1953
M3 rangefinder camera

style



Dieter Rams, 1958
pocket transistor radio T3



Henry Hobson Richardson, 1877
Trinity Church, Boston



Alfonso Bialetti, 1933
La Moka coffee maker



Leica, 1953
M3 rangefinder camera

broadening

broadening

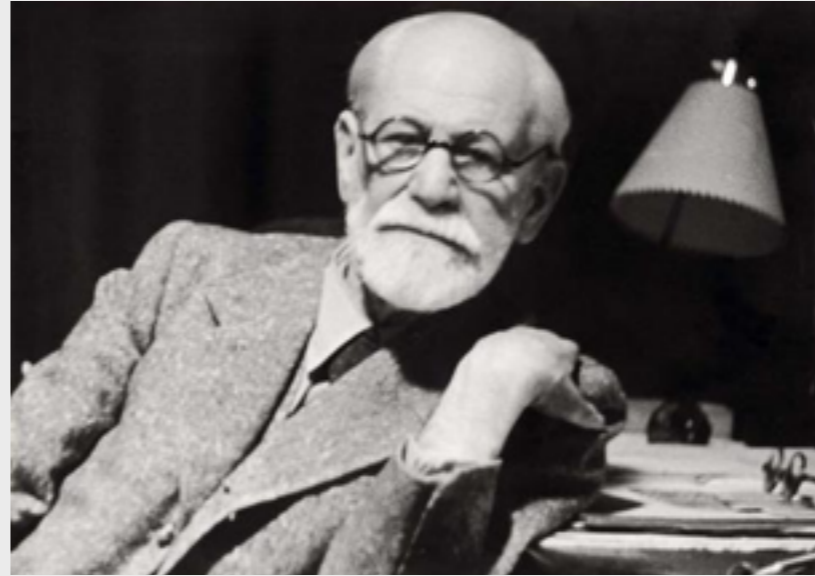

psychology

broadening



anthropology

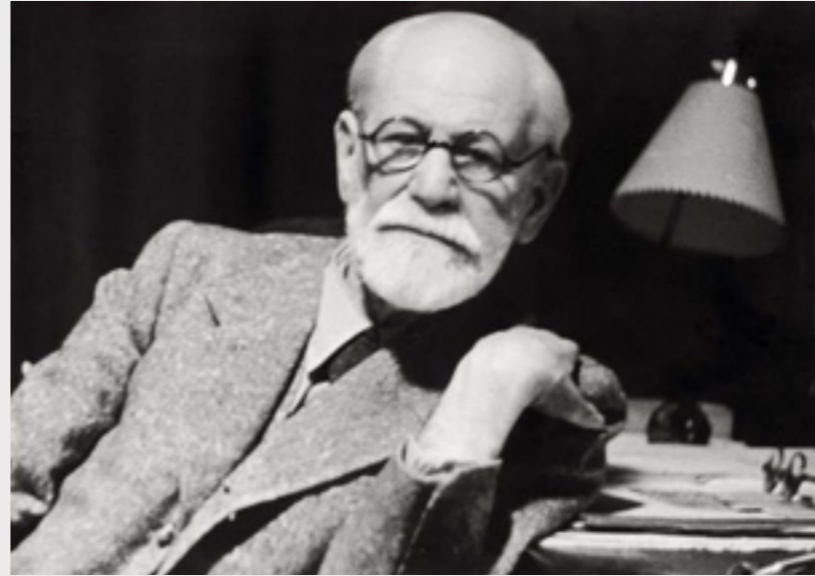

psychology

broadening



anthropology

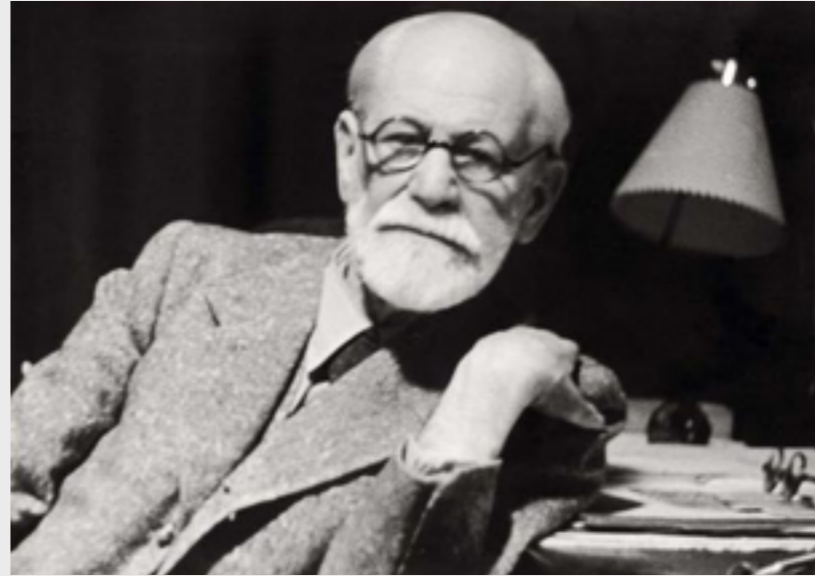

psychology



economics

broadening



anthropology

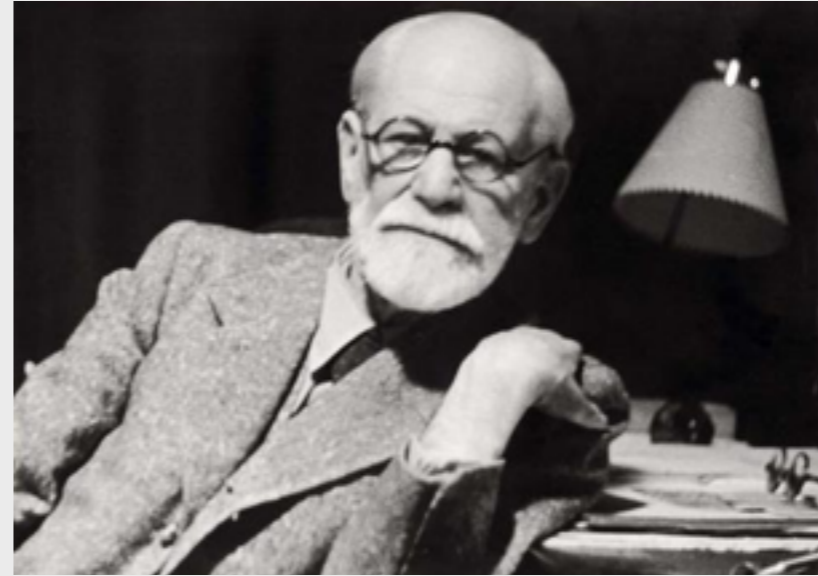

psychology



art



economics

nature of
software
design

fred brooks: essence and accident

fred brooks: essence and accident

[T]o see what rate of progress one can expect in software technology, let us examine the difficulties of that technology. Following Aristotle, I divide them into **essence**, the difficulties inherent in the nature of software, and **accidents**, those difficulties that today attend its production but are not inherent.

fred brooks: essence and accident

[T]o see what rate of progress one can expect in software technology, let us examine the difficulties of that technology. Following Aristotle, I divide them into **essence**, the difficulties inherent in the nature of software, and **accidents**, those difficulties that today attend its production but are not inherent.

The **essence of a software entity is a construct of interlocking concepts**: data sets, relationships among data items, algorithms, and invocations of functions. This essence is abstract in that such a conceptual construct is the same under many different representations. It is nonetheless highly precise and richly detailed.

fred brooks: essence and accident

[T]o see what rate of progress one can expect in software technology, let us examine the difficulties of that technology. Following Aristotle, I divide them into **essence**, the difficulties inherent in the nature of software, and **accidents**, those difficulties that today attend its production but are not inherent.

The **essence of a software entity is a construct of interlocking concepts**: data sets, relationships among data items, algorithms, and invocations of functions. This essence is abstract in that such a conceptual construct is the same under many different representations. It is nonetheless highly precise and richly detailed.

I believe **the hard part** of building software to be the specification, design, and testing of **this conceptual construct, not the labor of representing it** and testing the fidelity of the representation. We still make syntax errors, to be sure; but they are fuzz compared with the conceptual errors in most systems.

mental
models