

Hypercubic Networks

Charles E. Leiserson
6.895 Theory of Parallel Systems
November 2, 2003

1

“Ideal” Parallel Computer

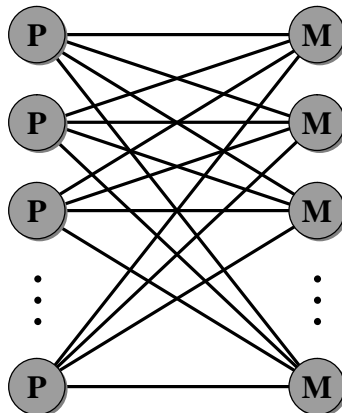

2

“Ideal” Distributed-Memory Parallel Computer

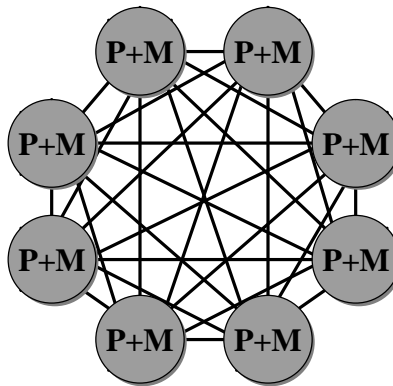

3

Interconnection Networks

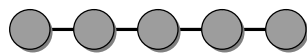

linear array

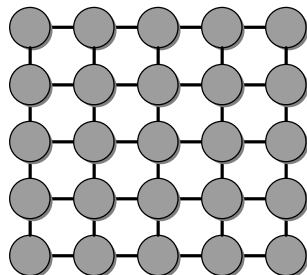

2D mesh

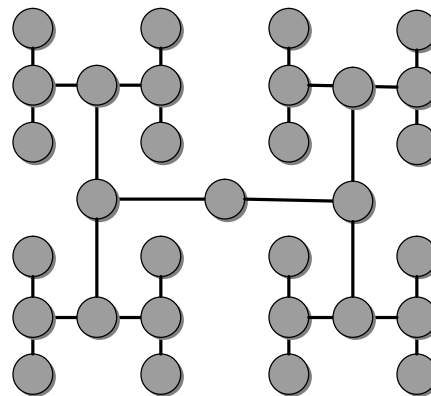

binary tree

4

Hypercube

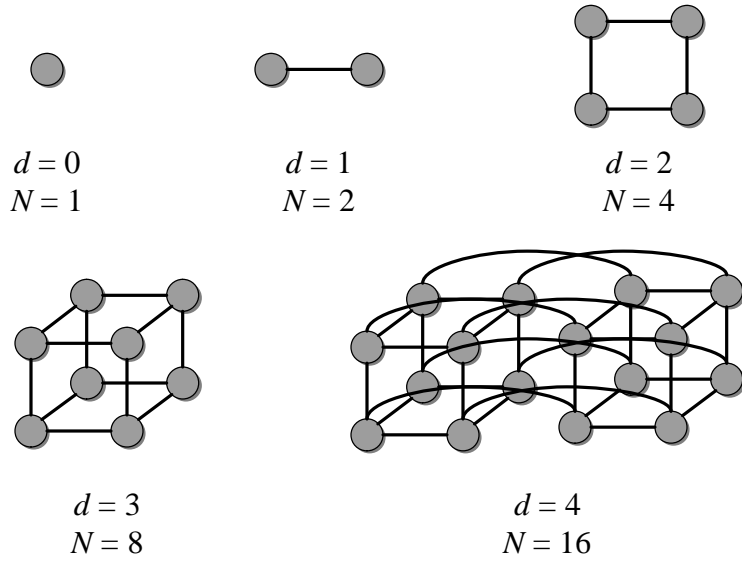

Hypercube

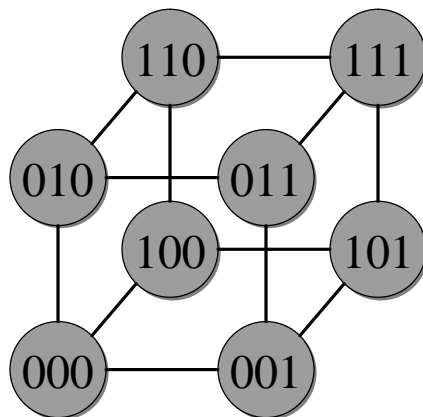

Cube-Connected Cycles

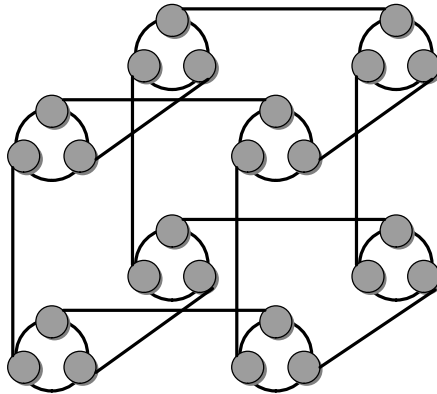

7

Butterfly (FFT) Network

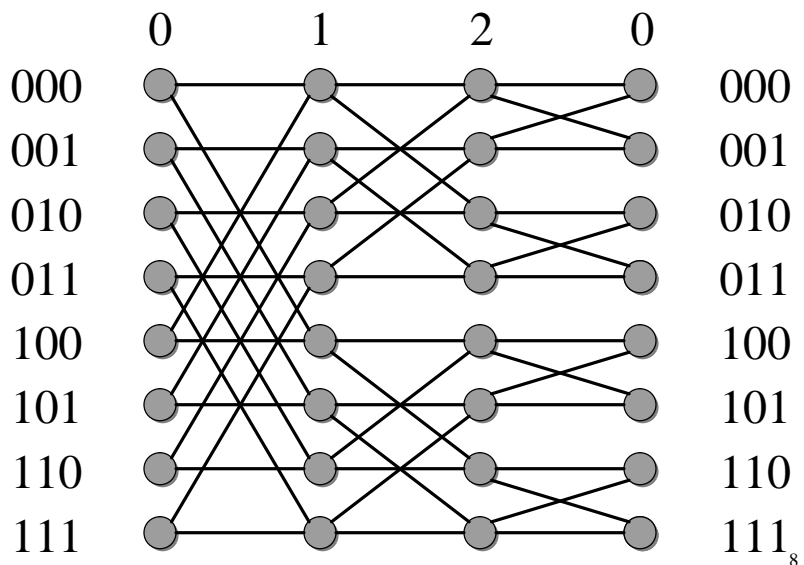

Butterflies

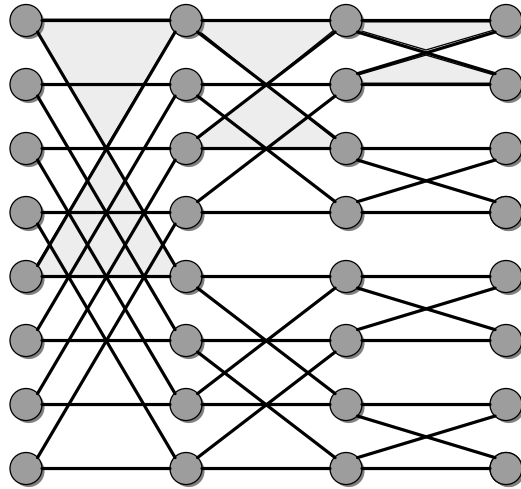

9

Decomposing a Butterfly

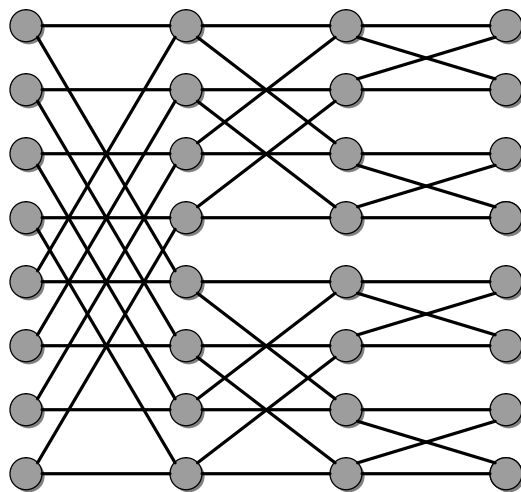

10

Decomposing a Butterfly

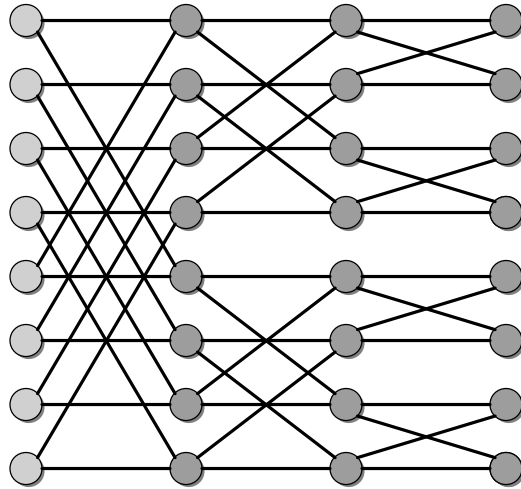

11

Decomposing a Butterfly

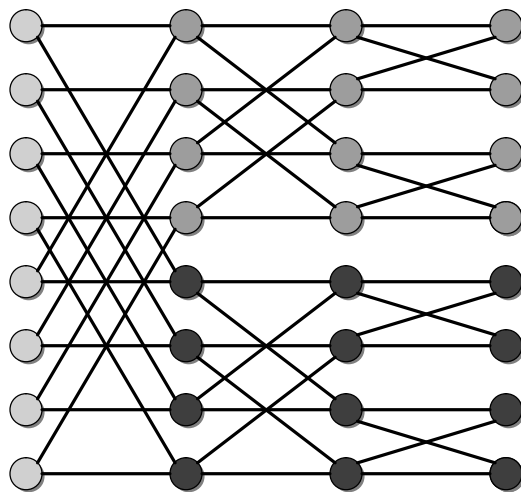

12

Decomposing a Butterfly

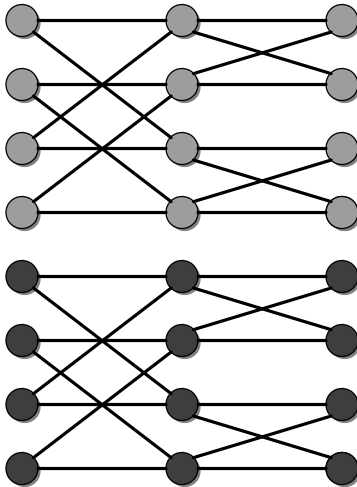

13

Decomposing a Butterfly II

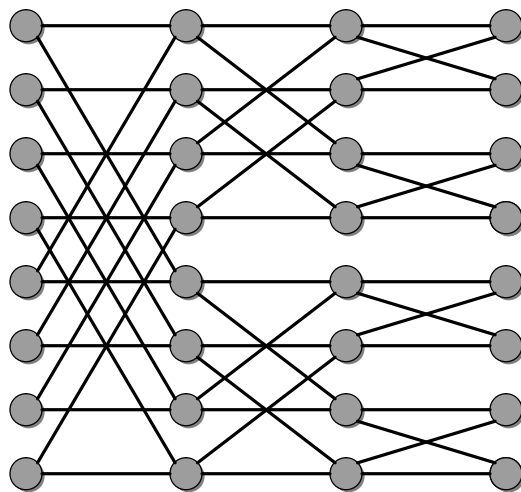

14

Decomposing a Butterfly II

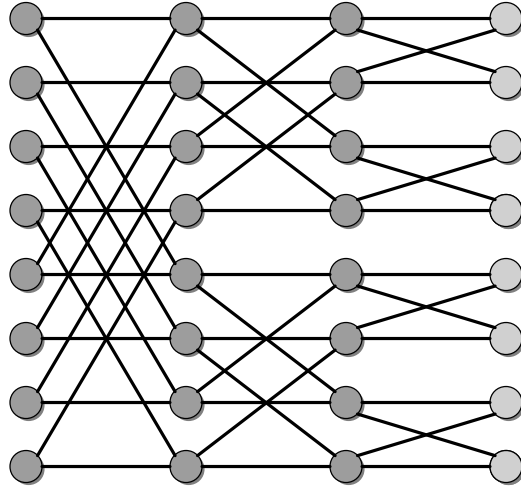

15

Decomposing a Butterfly II

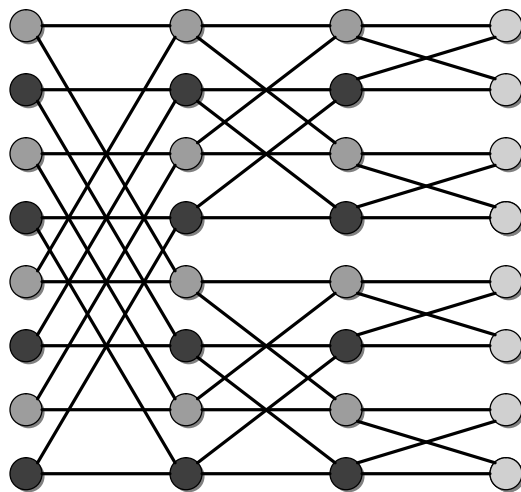

16

Decomposing a Butterfly II

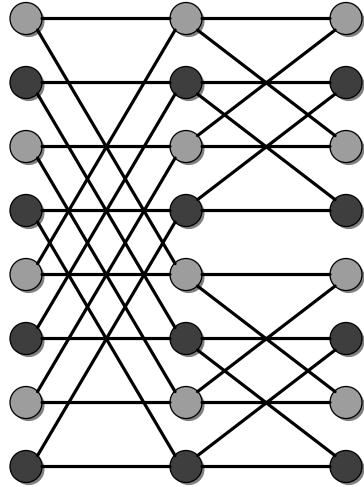

17

Decomposing a Butterfly II

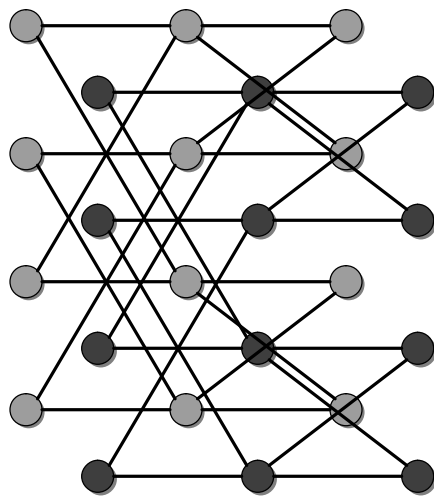

18

Decomposing a Butterfly II

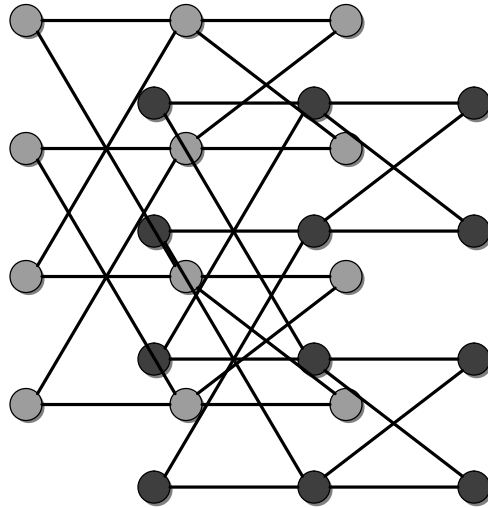

19

Decomposing a Butterfly II

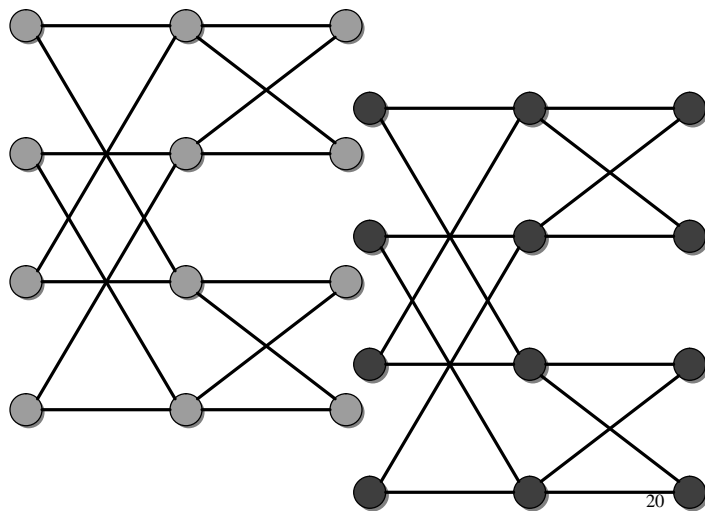

20

Routing on a Butterfly

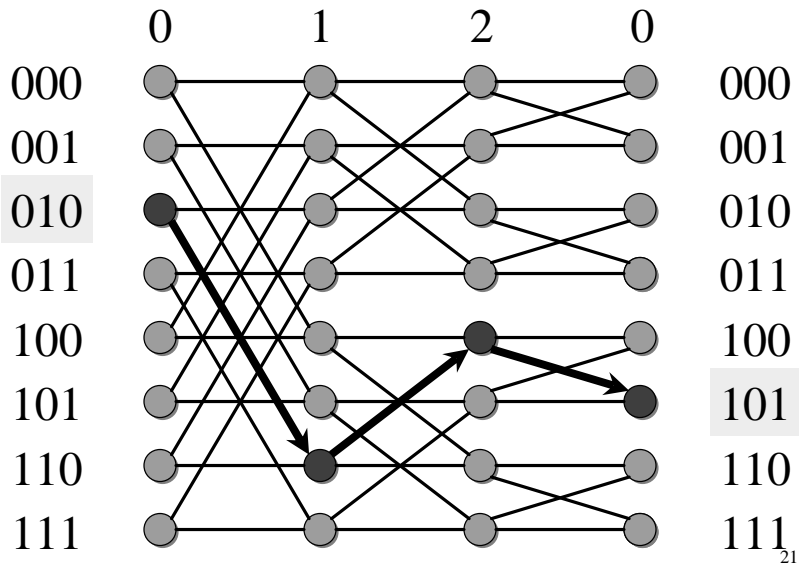

Tree in Butterfly

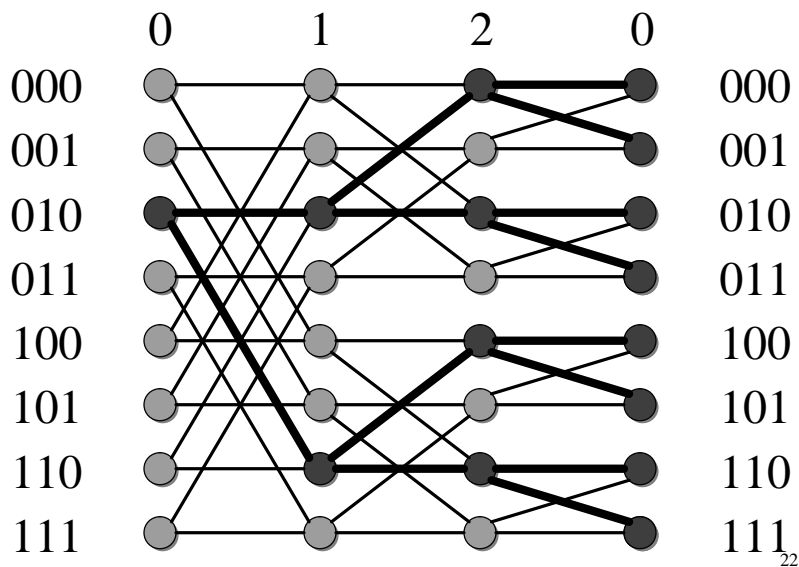

Tree in Butterfly

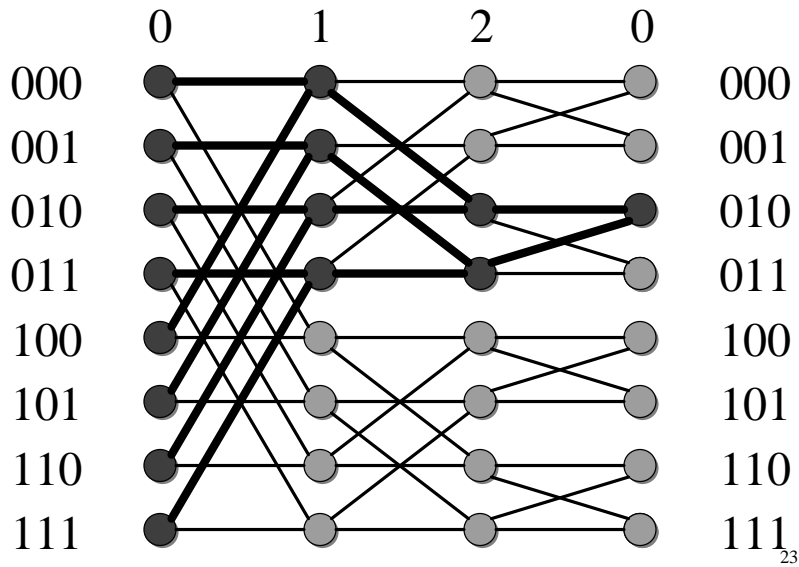

Beneš Network

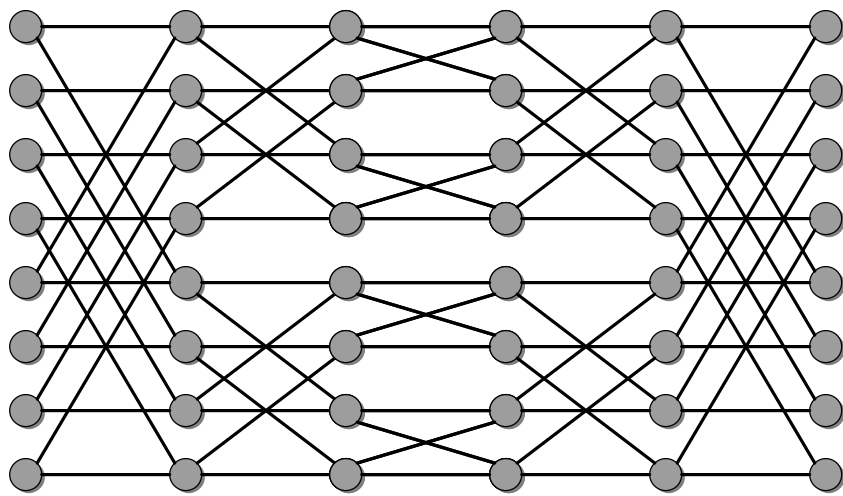

Decomposing a Beneš Network

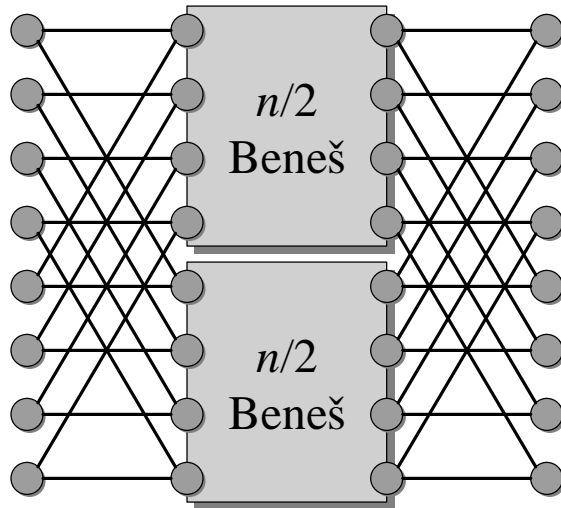

25

Routing on a Beneš Network

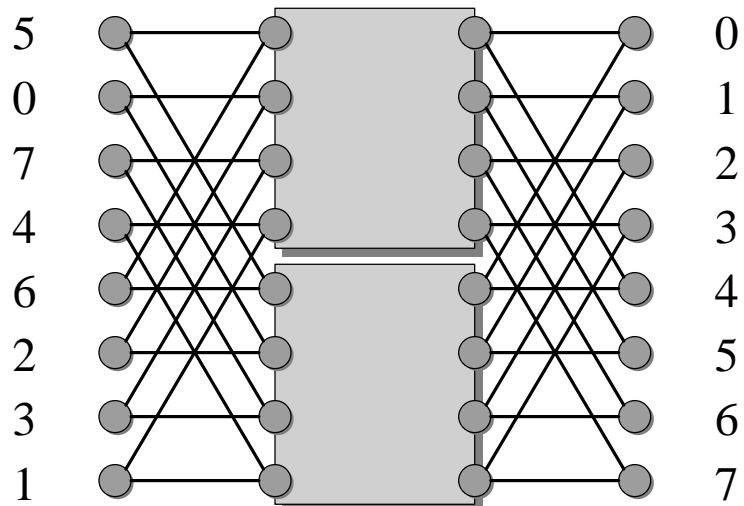

26

Routing on a Beneš Network

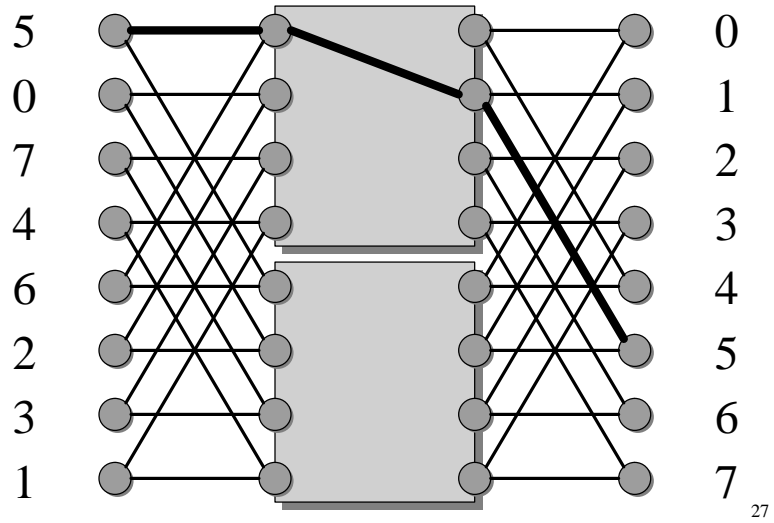

Routing on a Beneš Network

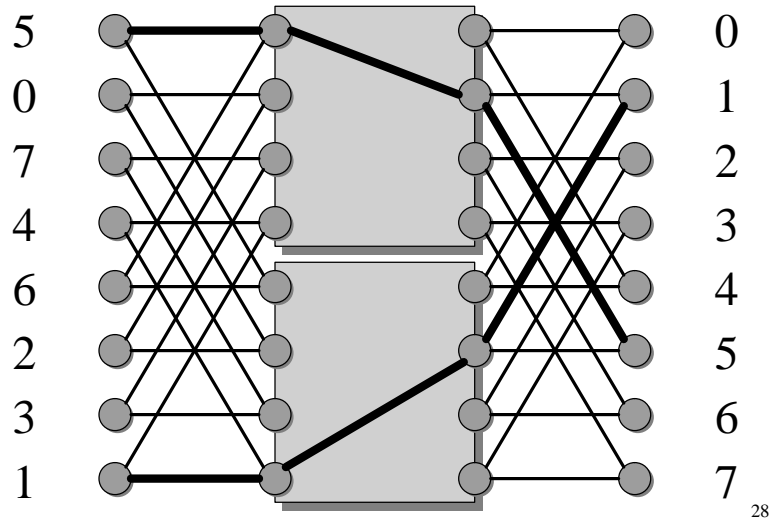

Routing on a Beneš Network

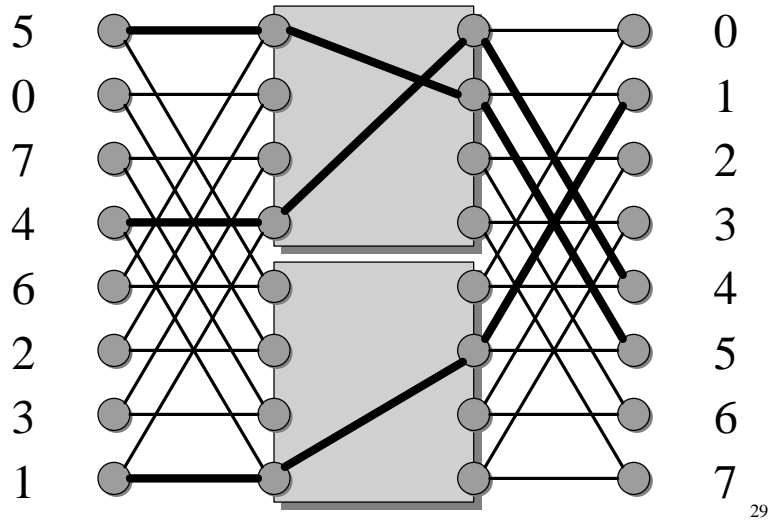

Routing on a Beneš Network

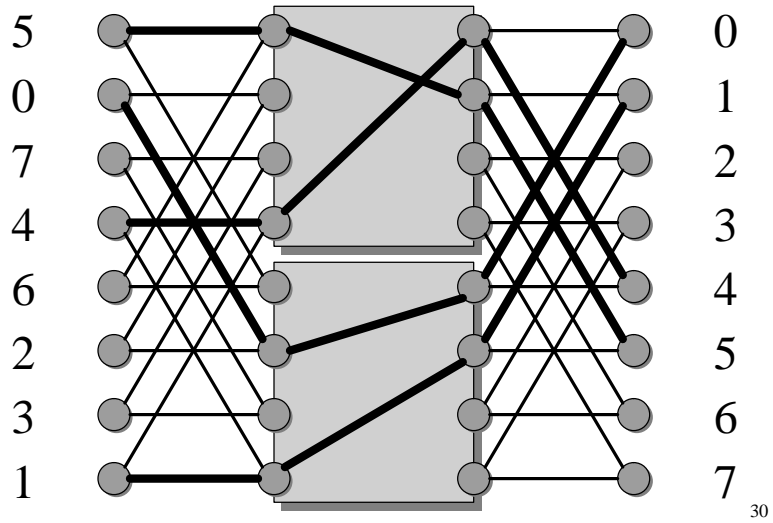

Routing on a Beneš Network

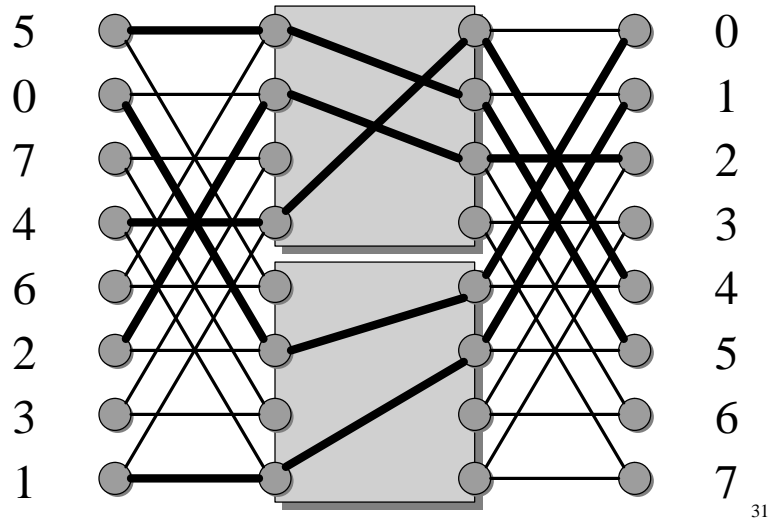

Routing on a Beneš Network

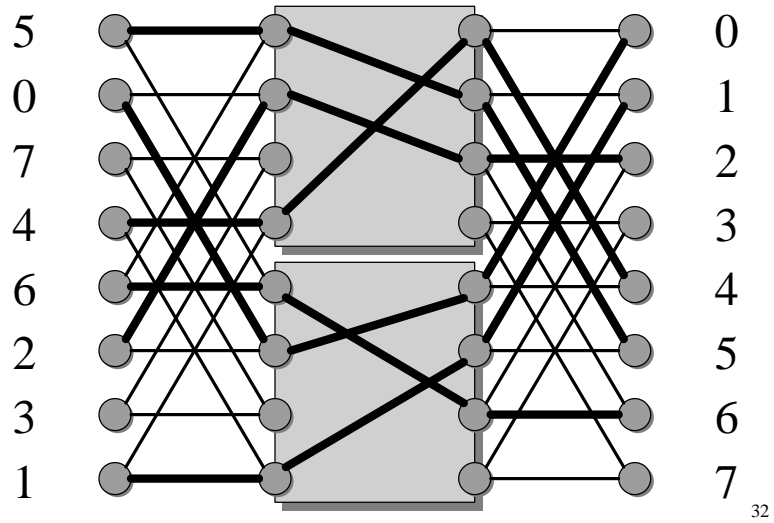

Routing on a Beneš Network

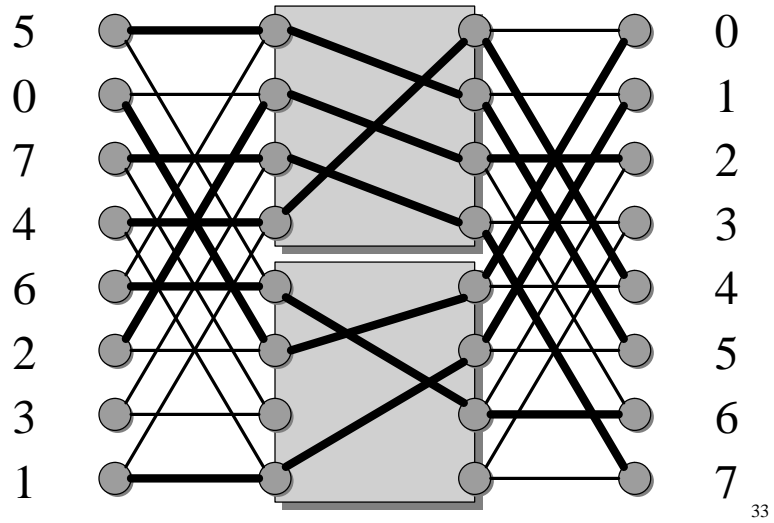

Routing on a Beneš Network

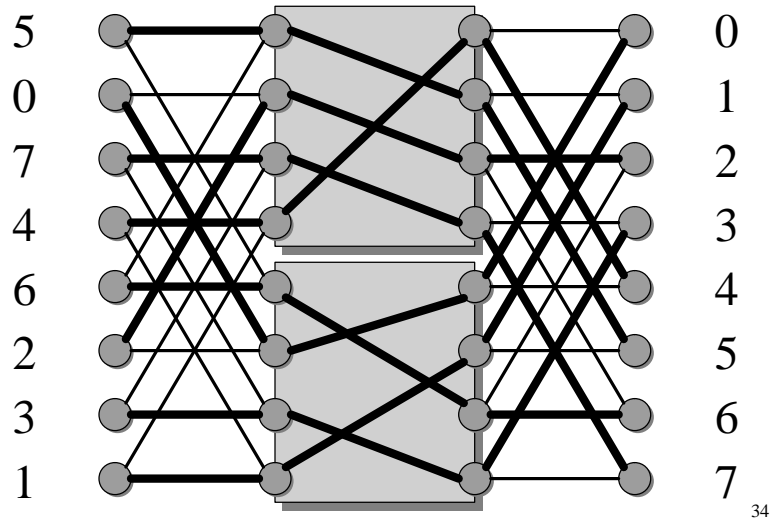

Routing on a Beneš Network

