

# Folding and Punching Paper

YASUHIKO ASAO<sup>1,a)</sup> ERIK D. DEMAINE<sup>2,b)</sup> MARTIN L. DEMAINE<sup>2,c)</sup> HIDEAKI HOSAKA<sup>3,d)</sup>  
AKITOSHI KAWAMURA<sup>4,e)</sup> TOMOHIRO TACHI<sup>4,f)</sup> KAZUNE TAKAHASHI<sup>1,g)</sup>

Received: xx xx, xxxx, Accepted: xx xx, xxxx

**Abstract:** We show how to fold a piece of paper and punch one hole so as to produce any desired pattern of holes. Given  $n$  points on a piece of paper (finite polygon or infinite plane), we give algorithms to fold the paper flat so that those  $n$  points and no other points of paper map to a common location, so that punching one hole and unfolding produces exactly the desired pattern of holes. Furthermore, we can forbid creases from passing through the points (allowing noncircular hole punches). Our solutions use relatively few creases (in some cases, polynomially many), and can be expressed as a linear sequence of folding steps of complexity  $O(1)$ —a generalization of simple folds which we introduce.

## 1. Introduction

In the *fold-and-cut problem* introduced at JCDGC'98 [5], we are given a planar straight-line graph drawn on a piece of paper, and the goal is to fold the paper flat so that exactly the vertices and edges of the graph (and no other points of paper) map to a common line. Thus, one cut along that straight line (and unfolding the paper) produces exactly the given pattern of cuts. This problem always has a solution [3], [6], though so far the complexity of the crease pattern depends on both the number  $n$  of vertices and the ratio  $r$  of the largest and smallest distances between nonincident vertices and edges. (A rough estimate on the complexity is  $O(nr)$ .)

In the *fold-and-punch problem*, we are given  $n$  points drawn on a piece of paper, and the goal is to fold the paper flat so that exactly those points (and no other points of paper) map to a common point. Thus, punching one hole at that point (and unfolding the paper) produces exactly the given pattern of holes. This problem is a natural analog of the fold-and-cut problem where we replace one-dimensional features and target (segments onto a common line) with zero-dimensional features and target (points onto a common point); thus, we also call the problem *zero-dimensional fold and cut*. This problem is also a special case of the *multidimensional*

*fold-and-cut problem* posed in [6], after Open Problem 26.32.

Directly applying a fold-and-cut solution to the graph with  $n$  vertices and zero edges does not solve the corresponding fold-and-punch problem, because the  $n$  points would come to a common line but not a common point. This discrepancy can be fixed by then making  $n - 1$  one-layer simple folds along perpendicular bisectors between consecutive points (all perpendicular to the common line).

Our goal in this paper is to find more efficient algorithms for the fold-and-punch problem. Indeed, unlike the fold-and-cut problem, we find solutions that use a number of creases depending only polynomially in  $n$ . We also consider four variations on the problem, based on two binary parameters:

**Paper size:** The paper can be either a bounded set or the infinite plane. Solutions to the fold-and-cut problem (with finitely many creases) are known only in the bounded case. The paper remains unbounded after any finite number of folds, making it difficult to prevent accidental alignment.

**Creasing through points:** Creases can be either permitted or forbidden to pass through the points to be aligned. Forbidding creases is useful, for example, if we want to punch a hole with a shape other than a circle. Even with a circular punch, creases through the hole give little tolerance for precise hole punching in practice. The solution above using fold-and-cut leads to creases at every point.

To quantify the efficiency of our solutions, we decompose our folding into a sequence of folding steps. In particular, our motivation is to generalize the notion of *simple fold* [1], [2], which allows folding along a single line or segment, and sequences of simple folds. More generally, we can decompose any folding of a piece of paper into a sequence of one or more *folding steps*. Each folding step starts from an already folded piece of paper (the result of the previous steps), and makes an arbitrary fold, producing another

<sup>1</sup> Graduate School of Mathematical Sciences, The University of Tokyo, 3–8–1 Komaba Meguroku, Tokyo 153–8914, Japan

<sup>2</sup> MIT Computer Science and Artificial Intelligence Laboratory, 32 Vassar Street Cambridge, Massachusetts 02139, USA

<sup>3</sup> Azabu Junior-High School, 2–3–29 Motoazabu, Minatoku, Tokyo 106–0046, Japan

<sup>4</sup> Graduate School of Arts and Sciences, The University of Tokyo, 3–8–1 Komaba Meguroku, Tokyo 153–8902, Japan

a) asao@ms.u-tokyo.ac.jp

b) edemaine@mit.edu

c) mdemaine@mit.edu

d) h\_hosaka314@hotmail.com

e) kawamura@graco.c.u-tokyo.ac.jp

f) tachi@idea.c.u-tokyo.ac.jp

g) kazune@ms.u-tokyo.ac.jp

folded state. Roughly, a folding step has *complexity*  $k$  if the paper can be decomposed into  $k + 1$  *clusters* (possibly disconnected regions) that each get folded as a single unit not sandwiched within any other cluster; refer to Section 2 for formal definitions. We call a folding step *flat* if the folded state is flat before and after the step, and *all-layers* if it treats the folded state before the step as a piece of paper (not separating any previously collocated layers). In particular, every some-layers simple fold is a flat folding step of complexity 1, and every all-layers simple fold is an all-layers flat folding step of complexity 1. At the other extreme, any folded state with  $k + 1$  faces in its crease pattern can be viewed as a sequence of just one folding step, of complexity  $k$ .

We can now measure the number of folding steps, the maximum complexity of the folding steps in the sequence, the total complexity of all the folding steps, etc., in addition to the usual measure of the total number of creases in the final folded state. In particular, a natural class of foldings studied here decompose into a sequence of flat folds of  $O(1)$  complexity — a natural generalization of a sequence of simple folds.

Table 1 summarizes the number of such folding steps that we use in our solution to each of the four variations of the problem, as well as the total number of creases in the final crease pattern (i.e., when viewing the folding as a single step). In some cases, we depend only on the number  $n$  of points; in other cases, we depend (usually, only logarithmically) on the ratio  $r$  of the largest and smallest distances between points.

**Table 1** Results: The number of flat folding steps of complexity  $O(1)$ , and the number of resulting creases, in our solutions to each of the four problem variants.

Paper	Allow Creases Through Points		Forbid Creases Through Points	
	Steps	Creases	Steps	Creases
Bounded	$O(n)$	$O(n^2)$	$O(n \log r)$	$O(n^3 r') = O(n^5 r)$
Unbounded	$O(n)$	$O(n^2)$	$O(n \log r)$	$O(n^2 r'') = O(n^4 r)$

For fun, we designed a typeface based on folding and one punch. Fig. 1 illustrates one font in the series, showing both crease pattern and resulting hole punches. Presenting the crease pattern and just one circle results in an intriguing puzzle font; see our web implementation.\*<sup>1</sup> See also [4] for related work on mathematical and puzzle fonts.

## 2. Folding Sequence Definition

In this section, we introduce the formal concept of a sequence of folds, and the complexity of the fold steps. This definition aims to generalize the idea of a sequence of simple folds in a way that will be useful beyond the work presented here.

First, we follow the definition of folded state by [6]:

**Definition 2.1** (Folded State). A *piece of paper*  $P$  is an orientable 2-manifold embedded in  $\mathbb{R}^3$ . A *folded state* or *folding*  $(f, \lambda)$  of  $P$  consists of an intrinsically isometric *geometry*  $f : P \rightarrow \mathbb{R}^3$  and an *ordering*  $\lambda : L \rightarrow \{-1, +1\}$ , where  $L = \{(p, q) \in P \times P \mid p, q$

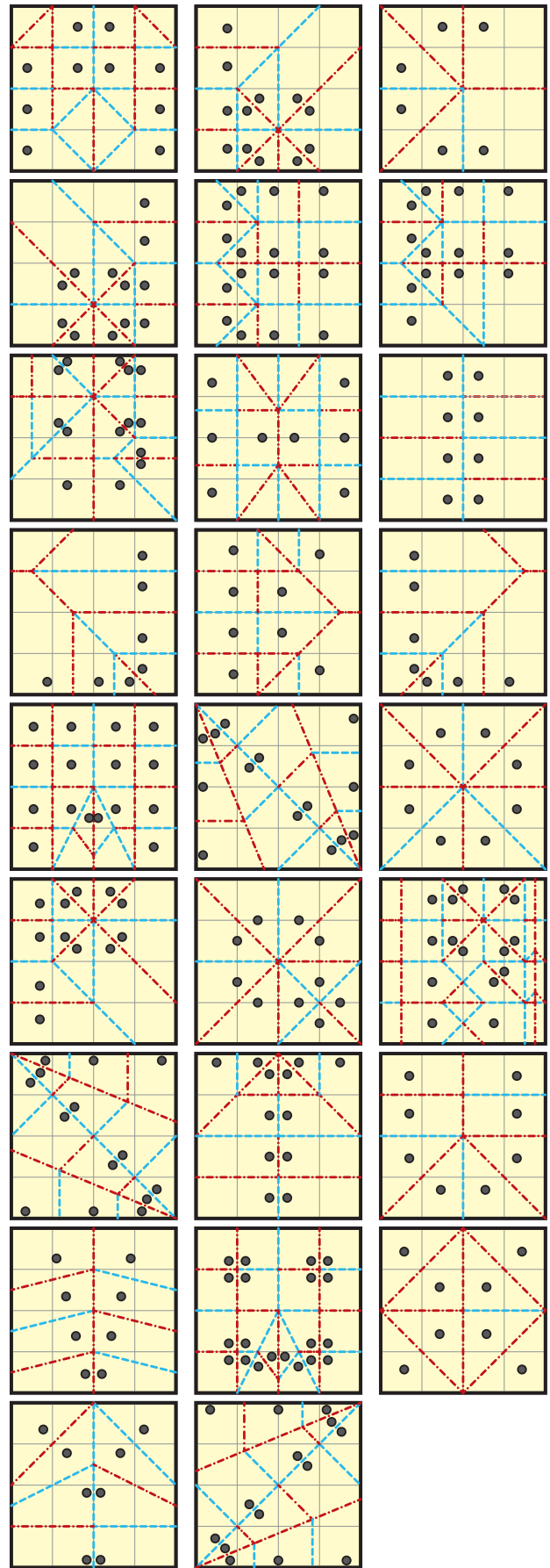

**Fig. 1** Creating every letter of the alphabet by folding (along the specified crease pattern) and one punch, resulting in the circular holes. These foldings were designed by hand to be as simple as possible, using the ORIPA software. Amusingly, M and W use the same crease pattern, without rotation or reflection.

\*<sup>1</sup> <http://erikdemaine.org/fonts/foldpunch/>

are nonincrease points of  $f$ , and  $f(p) = f(q)$ , satisfying Antisymmetry, Transitivity, Consistency, and Noncrossing conditions [6]. Here  $\lambda(p, q) = +1$  means that point  $p$  is stacked above  $q$  (in the direction of the normal  $\mathbf{n}_f(q)$  of the folded surface at  $q$ ), and  $\lambda(p, q) = -1$  means that  $p$  is stacked below  $q$  (in the direction  $-\mathbf{n}_f(q)$ ).

**Definition 2.2** (Folding Step). A folding step consists of a before folded state  $(f_0, \lambda_0)$  and an after folded state  $(f_1, \lambda_1)$ ; we call the folding step from  $(f_0, \lambda_0)$  to  $(f_1, \lambda_1)$ . Let  $L_j$  denote the domain of  $\lambda_j$ , i.e., all pairs of nonincrease points mapped together by  $f_j$ .

A folding step is flat if both  $f_0(P)$  and  $f_1(P)$  lie in the  $xy$  plane.

**Definition 2.3** (Folding Step Complexity). A folding step of complexity  $k$  from  $(f_0, \lambda_0)$  to  $(f_1, \lambda_1)$  consists of a clustering  $C_0, C_1, \dots, C_k$  satisfying the following properties:

- (C1) **Clusters partition paper:**  $C_0, C_1, \dots, C_k$  are disjoint open sets partitioning  $P$ , i.e.,  $P = \overline{C_0} \cup \overline{C_1} \cup \dots \cup \overline{C_k}$  where  $\overline{X}$  denotes the closure of  $X$ .
- (C2) **Cluster geometry:** On each cluster  $C_i$ ,  $f_0$  and  $f_1$  differ by only a rigid motion  $g_i$ , i.e.,  $(f_1)|_{C_i} = g_i \circ (f_0)|_{C_i}$ . Furthermore,  $g_0$  is the identity map, i.e.,  $C_0$  does not move geometrically. As a consequence,  $L_0 \cap (C_i \times C_i) = L_1 \cap (C_i \times C_i)$ .
- (C3) **Cluster layering:** For each cluster  $C_i$ ,  $\lambda_0$  and  $\lambda_1$  agree on all points in  $C_i$  where they are defined, i.e.,  $(\lambda_0)|_{L_0 \cap (C_i \times C_i)} = (\lambda_1)|_{L_1 \cap (C_i \times C_i)}$ .
- (C4) **Clusters don't sandwich:** For each cluster  $C_i$ , for both folded states  $(f_j, \lambda_j)$ , and for any point pair  $(p, q) \in L_j \cap (C_i \times C_i)$ , there is no point  $b \in P \setminus C_i$  in between  $p$  and  $q$  according to  $(f_j, \lambda_j)$ , i.e., no nonincrease point  $b \in P \setminus C_i$  with  $f_j(b) = f_j(p) = f_j(q)$  satisfying  $\lambda_j(p, b) \neq \lambda_j(q, b)$ .

Note that the number of clusters is 1 larger than the complexity, so that complexity 0 corresponds to no folding whatsoever. This definition of folding step complexity is nicely general, but it still allows the layering to be complex even in a folding step of complexity 1. Fig. 2 shows how we may “weave” folded shapes without increasing the complexity.

For example, a (some-layers) *simple fold* is a flat folding step of complexity 1 satisfying three additional conditions:

- (S1) Rigid motion  $g_1$  is not the identity, and thus is a reflection about a line  $\ell_1$ .
- (S2) For some sign  $\sigma \in \{+1, -1\}$ , there are no collisions during a continuous  $\sigma$  180° rotation of  $C_1$  around  $\ell_1$ , or equivalently,  $C_1$  is on the same side of  $C_0$  before and after the folding step:  $\lambda_j(p, q) \mathbf{n}_{f_j}(q) = \sigma \mathbf{e}_z$  for all  $(p, q) \in L_j \cap (C_1 \times C_0)$  and for both  $j \in \{0, 1\}$ . (Here  $\mathbf{e}_z$  represents the vector  $(0, 0, +1)$ .)
- (S3) Every point of  $\overline{C_0} \cap \overline{C_1}$  is a crease point of  $f_1$  or on the boundary of  $P$ .

This definition exactly matches the definition of simple fold in [1]. Without Property S3, we call such a folding step a (some-layers)

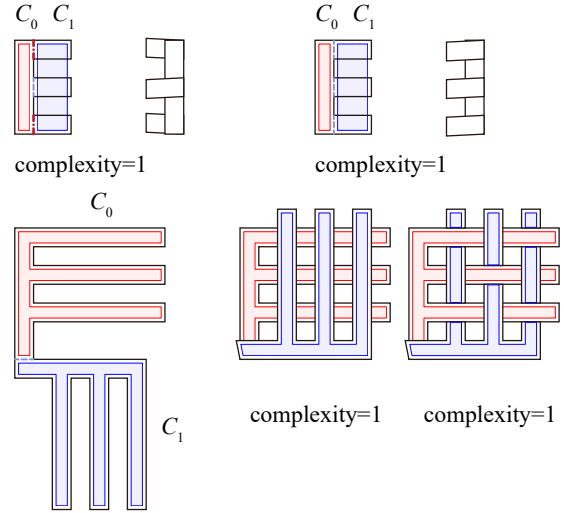

Fig. 2 Weaving with folding steps of complexity 1.

*simple fold/unfold*.

At the other extreme in complexity, any target folded state  $(f_1, \lambda_1)$  can be viewed as a folding step from the unfolded piece of paper (given by geometry  $f_0(p) = p$ ) to  $(f_1, \lambda_1)$ . By choosing the clusters to be the  $k + 1$  faces of the crease pattern of  $f_1$ , the complexity of this step is  $k$  (assuming  $f_1$  is a rigid motion on each face of the crease pattern). We refer to  $k$  as the *face complexity* of  $(f_1, \lambda_1)$ .

Next we define a common type of folding step that treats the result of a previous folding step as its “piece of paper”, and thus does not separate any previously collocated layers of paper:

**Definition 2.4** (All-layers Folding Step). Given a folded state  $(f_0 : P \rightarrow \mathbb{R}^3, \lambda_0)$ , whose image  $f_0(P)$  is an orientable manifold  $P'$  (with normals  $\mathbf{n}_{P'}$  defined by an arbitrarily chosen “top” side), and given a second folded state  $(f_{0 \rightarrow 1} : P' \rightarrow \mathbb{R}^3, \lambda_{0 \rightarrow 1})$ , define the *all-layers folding step* from  $(f_0, \lambda_0)$  to  $(f_1, \lambda_1)$  by

$$f_1 = f_{0 \rightarrow 1} \circ f_0,$$

$$\lambda_1(p, q) = \begin{cases} \lambda_0(p, q) & (f_0(p) = f_0(q)), \\ \lambda_{0 \rightarrow 1}(f_0(p), f_0(q)) \cdot \sigma_{f_0}(q) & (f_0(p) \neq f_0(q)), \end{cases}$$

where  $\sigma_{f_0}(q) = \mathbf{n}_{P'}(f_0(q)) \cdot \mathbf{n}_{f_0}(q)$  indicates whether  $q$ 's normal vector on  $P$  as mapped by  $f_0$  matches or is flipped relative to the normal vector of  $f_0(q)$  on the coalesced surface  $P'$ .

If  $(f_{0 \rightarrow 1}, \lambda_{0 \rightarrow 1})$  has face complexity  $k$ , then there is an all-layers folding step from  $(f_0, \lambda_0)$  to  $(f_1, \lambda_1)$  of complexity  $k$ .

For example, an *all-layers simple fold* is a simple fold that is an all-layers folding step (for some  $f_{0 \rightarrow 1}$ ). This definition exactly matches the definition of all-layers simple fold in [1].

**Definition 2.5** (Folding sequence). A *folding sequence* is a sequence  $(f_0, \lambda_0), (f_1, \lambda_1), \dots, (f_m, \lambda_m)$  of folded states and a sequence  $s_0, s_1, \dots, s_{m-1}$  of folding steps, where each  $s_i$  is a folding step from  $(f_i, \lambda_i)$  to  $(f_{i+1}, \lambda_{i+1})$ . The *result* of the folding sequence is  $(f_m, \lambda_m)$ . The folding sequence is *complete* if  $(f_0, \lambda_0)$

is the unfolded piece of paper, given by geometry  $f_0(p) = p$ .

*Remark 2.6.* A folded state  $(f, \lambda)$  can be the result of multiple different folding sequences. Fig. 3 shows an example of folding which can be reached by either (1) a sequence of one simple fold (complexity 1) followed by one all-layers flat folding step of complexity 5; or (2) one flat folding step of complexity 11.

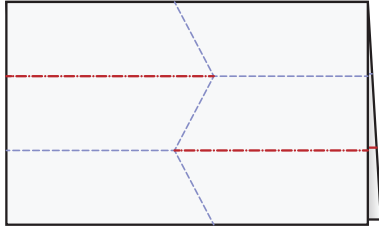

Fig. 3 An example of an all-layers flat folding step of complexity 5.

### 3. Problem and Results

In this section, we formally state the 0-dimensional fold-and-cut problem and describe our results.

**Problem 3.1** (0-dimensional fold and cut). *Given  $n$  points  $p_1, p_2, \dots, p_n$  on a flat piece of paper  $P$ , find a flat folding  $(f, \lambda)$  satisfying the following conditions:*

- (F1)  $f(p_1) = f(p_2) = \dots = f(p_n)$ .
- (F2)  $f(q) \neq f(p_1)$  for any  $q \in P \setminus \{p_1, p_2, \dots, p_n\}$ .

We have four variations of this problem based on the following two criteria:

- The paper  $P$  is bounded or unbounded.
  - (Bounded) The paper  $P \subset \mathbb{R}^2$  is bounded.
  - (Unbounded) The paper  $P = \mathbb{R}^2$  is the infinite plane.\*2
- We can allow or forbid crease lines passing through given points:
  - (Allowing) Allow crease lines passing through  $\{p_i\}$ .
  - (Forbidding) Forbid crease lines passing through  $\{p_i\}$ .

Our main results are summarized by the following theorem:

**Theorem 3.2.** *Problem 3.1 is always solvable in all four cases above. The solution can always be given by a sequence of flat folding steps, each of complexity  $O(1)$ . Furthermore, every folding step is either a some-layers simple fold or an all-layers folding step; and in the bounded-paper cases, every folding step is a some-layers simple fold. Table 1 bounds the number of steps and the number of resulting creases in the crease pattern in each case.*

*Remark 3.3.* For Problem 3.1 with bounded paper, any shape of paper  $P$  is accepted. If we solve the problem for larger finite paper  $P'$  containing original paper  $P$ , then we have a solution for the original paper  $P$ . Thus our solution is free to choose the shape of  $P'$ , e.g., to be convex (say, the convex hull of  $P$ ) or a rectangle (say, the bounding box of  $P$ ).

\*2  $\mathbb{R}^2$  is the hardest case of any unbounded piece of paper: a solution to  $P = \mathbb{R}^2$  can be applied to its subset.

### 3.1 Key Ideas

We present our solutions to the four cases in order of increasing solution complexity: bounded & allowing case (Section 4), unbounded & allowing case (Section 5), bounded & forbidding case (Section 6), and unbounded & forbidding case (Section 7). The latter two sections can be read independently from the others, so to see the most general result and techniques, the reader may skip to Section 7.

In the bounded & allowing case (Section 4), unbounded & allowing case (Section 5), and unbounded & forbidding case (Section 7), we use the following fundamental technique. We perform some folds in order to place  $p_1, p_2, \dots, p_n$  on the same horizontal line such that each  $p_i$  is not covered by any other layers of paper. Then, by just folding bisecting vertical lines, we can easily obtain a flat folding satisfying Properties F1 and F2; refer to Fig. 4.

**Lemma 3.4** (Bisection Folding). *Let  $P$  be a piece of paper. If all  $p_i$ 's are on the same line  $\ell$ , we can get such a folding satisfying Properties F1 and F2, without adding crease lines through  $\{p_i\}$ . This construction results from a folding sequence of  $\Theta(n)$  some-layers simple folds, and works if  $P$  is bounded or unbounded.*

*Proof.* Consider  $\ell$  as the  $x$  axis. Let  $x_i$  be the  $x$  coordinate of  $p_i$ . By relabeling the points, we can arrange for  $x_1 < x_2 < \dots < x_n$ . For each  $i = 1, 2, \dots, n - 1$  in turn, we fold a vertical crease at  $x = (x_i + x_{i+1})/2$ , mountain if  $i$  is odd and valley if  $i$  is even.  $\square$

In the bounded & forbidding case (Section 6), making the points collinear by simple folds is difficult. Instead we can make the points arbitrarily close to collinear, using radial “shrink folding”. Then we observe that bisection folding of Fig. 4 is really folding along a Voronoi diagram of the points, and for points close enough to collinear, the Voronoi edges do not intersect on a bounded piece of paper. Therefore we can use this generalized form of bisection folding in this case; see Section 6 for details. Unfortunately, we do not know how to deal with Voronoi vertices, making it difficult to apply Voronoi diagrams directly to the entire problem.

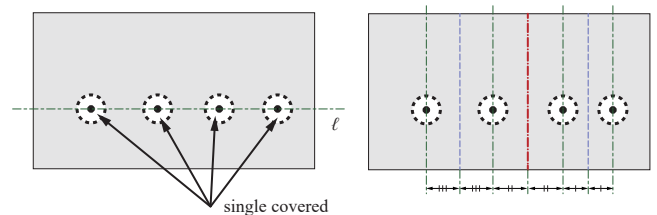

Fig. 4 Bisection folding to align collinear points.

### 3.2 Feature Ratios

In the forbidding cases, our algorithms depend on geometric features of the input, not just the number  $n$  of points. (For the allowing case, the reader may safely skip this section.) The standard measure for capturing such geometric dependence is the *feature ratio*  $r$ —the ratio of the maximum and minimum feature sizes—which in this problem is given by

$$r = \frac{\max_{i,j} \text{dist}(p_i, p_j)}{\min_{i \neq j} \text{dist}(p_i, p_j)}.$$

Here  $p_i$  is chosen from the points defined in Problem 3.1, and in

the case of bounded paper  $P$ , with the additional four corners of the bounding box of  $P$ . Our algorithms more naturally refer to two variations of feature ratio, which we will relate back to  $r$ :

**Definition 3.5.** In the bounded & forbidding case, we define the *radial feature ratio*

$$r' = \frac{\max_i R_i}{\min_{i \neq j} |R_i - R_j|}, \quad (1)$$

where, for each  $1 \leq i \leq n$ ,  $R_i$  is the distance of  $p_i$  from the origin  $p_0$ , which we assume is exterior to the paper.

**Definition 3.6.** In the unbounded & forbidding case, we define the *projected feature ratio*

$$r'' = \frac{\max_{i \neq j} |y_i - y_j|}{\min(\min_{i \neq j} |x_i - x_j|, \min_{i \neq j} |y_i - y_j|)}, \quad (2)$$

where, for each  $1 \leq i \leq n$ ,  $(x_i, y_i)$  is the coordinate of  $p_i$  (choosing the coordinate system to make the  $x_i$ 's and  $y_i$ 's distinct).

The radial and projected feature ratios are related to the standard feature ratio by “only” a polynomial function of  $n$ :

**Lemma 3.7.** Any  $n$  points have a rotation for which  $r'' = O(rn^2)$ .

*Proof.* Draw the complete graph on the  $n$  points, connecting every pair of points with a segment. Thus we obtain  $\Theta(n^2)$  segments, each with an (unoriented) direction, which we can view as two antipodal points on the circle of directions. For each such pair of directions, draw also the two perpendicular directions. Among  $\Theta(n^2)$  such points, there must be an empty interval on the circle of directions of length  $\Omega(\frac{1}{n^2})$ . Choose the midpoint of this interval as the direction for the  $x$  axis, and the  $y$  axis perpendicular to  $x$ .

Now look at the projections of the segments onto the  $x$  and  $y$  axes. The longest segment in projection must be shorter or equal than the length  $L$  of the longest segment, so the numerator of  $r''$  is at most  $L$ . The shortest segment in projection forms angle  $\Omega(1/n^2)$  with respect to the projection direction ( $x$  or  $y$ ) by construction, and has unprojected length at least the shortest overall length  $\ell$ , so the projected length must be  $\Omega(\ell/n^2)$ . Therefore the projected feature ratio  $r''$  is  $O(L)/\Omega(\ell/n^2) = O((L/\ell)n^2) = O(rn^2)$ .  $\square$

**Lemma 3.8.** Any  $n$  points have a translation for which  $r' = O(rn^2)$  and  $p_0$  is exterior to the bounded paper  $P$ .

*Proof.* Let  $L = \max_{i,j} \text{dist}(p_i, p_j)$  be the maximum distance between two points (including points of the bounding box of  $P$ ). Consider the circle  $C$  of radius  $10L$  centered at one of the points  $p_1$ . For every pair  $(p_i, p_j)$  of points, draw the perpendicular bisector line. These  $\Theta(n^2)$  lines intersect circle  $C$  at  $\Theta(n^2)$  points. These intersection points divide  $C$  into  $\Theta(n^2)$  intervals, one of which must have angular length  $\Omega(1/n^2)$  and thus circumference  $\Omega(L/n^2)$ . Choose  $p_0$  to be the center of this interval. Because  $p_0$  is on the circle  $C$ , we have  $9L \leq R_i \leq 11L$  for all  $i$ . In particular,  $p_0$  is exterior to the paper.

Now consider any two points  $p_i, p_j$  with  $i \neq j$ , whose distance  $d$  satisfies  $\ell \leq d \leq L$  where  $\ell$  is the minimum distance between any two points. Refer to Fig. 5. Let  $x$  be  $p_0$ 's orthogonal distance from the perpendicular bisector of  $p_i$  and  $p_j$ . We have  $x = \Omega(L/n^2)$ .

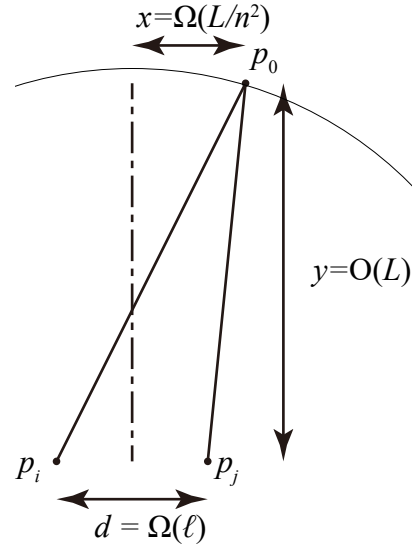

Fig. 5 Analyzing the radial feature ratio in Lemma 3.8.

Let  $y$  be the distance between  $p_i$  (and  $p_j$ ) and  $p_0$  when projected onto the perpendicular bisector. The quantity  $\sqrt{x^2 + y^2}$  measures the distance between  $p_0$  and the midpoint between  $p_i$  and  $p_j$ , so  $9L \leq \sqrt{x^2 + y^2} \leq 11L$ . After possibly swapping  $p_i$  and  $p_j$ , we have

$$R_i = \sqrt{(x + d/2)^2 + y^2} = \sqrt{x^2 + y^2 + d^2/4 + xd},$$

$$R_j = \sqrt{(x - d/2)^2 + y^2} = \sqrt{x^2 + y^2 + d^2/4 - xd}.$$

Dividing by  $D = \sqrt{x^2 + y^2 + d^2/4} = \Theta(L)$ ,

$$\frac{R_i}{D} = \sqrt{1 + \frac{xd}{x^2 + y^2 + d^2/4}},$$

$$\frac{R_j}{D} = \sqrt{1 - \frac{xd}{x^2 + y^2 + d^2/4}}.$$

We have  $xd \leq (11L)L \leq 11L^2$ , while  $x^2 + y^2 \geq (9L)^2 \geq 81L^2$ . Thus  $\frac{xd}{x^2 + y^2 + d^2/4} < 1$ . By Taylor's Theorem,  $\sqrt{1 + \varepsilon} = 1 + \Theta(\varepsilon)$  and  $\sqrt{1 - \varepsilon} = 1 - \Theta(\varepsilon)$  for  $0 \leq \varepsilon < 1$ . Therefore

$$\frac{R_i}{D} = 1 + \Theta\left(\frac{xd}{x^2 + y^2 + d^2/4}\right),$$

$$\frac{R_j}{D} = 1 - \Theta\left(\frac{xd}{x^2 + y^2 + d^2/4}\right),$$

so

$$\frac{R_i - R_j}{D} = \Theta\left(\frac{xd}{x^2 + y^2 + d^2/4}\right).$$

Substituting various approximations, we obtain

$$\frac{R_i - R_j}{\Theta(L)} = \Theta\left(\frac{\Omega(L/n^2)\Omega(\ell)}{\Theta(L^2) + O(L^2)}\right) = \Omega\left(\frac{\ell}{Ln^2}\right) = \Omega\left(\frac{1}{rn^2}\right).$$

Taking the reciprocal, we have

$$r' = \frac{\max_i R_i}{\min_{i \neq j} |R_i - R_j|} = \frac{\Theta(L)}{\min_{i \neq j} |R_i - R_j|} = O(rn^2)$$

as desired.  $\square$

**Remark 3.9.** Solutions to Problem 3.1 with unbounded paper can



be applied to Problem 3.1 with bounded paper, and solutions to Problem 3.1 forbidding creases through points can be applied to Problem 3.1 allowing creases through points. Therefore, if we apply the solution of the unbounded & forbidding case to the bounded & forbidding case, we obtain the number of creases as  $O(n^2r)$ , which is a better bound than  $O(n^3r)$ , but it does not consist of only simple folds.

#### 4. Solution for Bounded Paper, Allowing Creases Through Points

**Theorem 4.1.** *Let  $P$  be a bounded piece of paper and let  $p_1, p_2, \dots, p_n$  be  $n$  distinct points on  $P$ . Then there exists a flat folding satisfying Properties F1 and F2, allowing creases through  $\{p_i\}$ . The number of creases is  $O(n^2)$ . The flat folding is the result of a folding sequence of  $O(n)$  some-layers simple folds.*

*Proof.* We can reduce to the case of Lemma 3.4 as follows. Rotate so that  $p_1, p_2, \dots, p_n$  have distinct  $y$  coordinates  $y_1, y_2, \dots, y_n$ . Relabel the points so that  $y_1 > y_2 > \dots > y_n$ . If we fold the paper by horizontal mountain creases  $y = y_i$  for  $1 \leq i \leq n$ , and horizontal valley creases  $y = (y_i + y_{i+1})/2$  for  $1 \leq i \leq n - 1$ , then we will align the  $p_i$ 's onto a horizontal line, but other points will fold to meet  $p_i$ ; see Fig. 6 (left). If we reverse-fold the mountain folds, turning horizontal crease  $y = (y_i + y_{i+1})/2$  into a valley and adding two mountain crease lines at  $p_i$  with very small angle to the horizontal crease  $y = (y_i + y_{i+1})/2$ , then the creases will not intersect, so we obtain the desired result; see Fig. 6 (right). Now each  $p_i$  is not covered by any other points, so we can reduce to the case of Lemma 3.4.

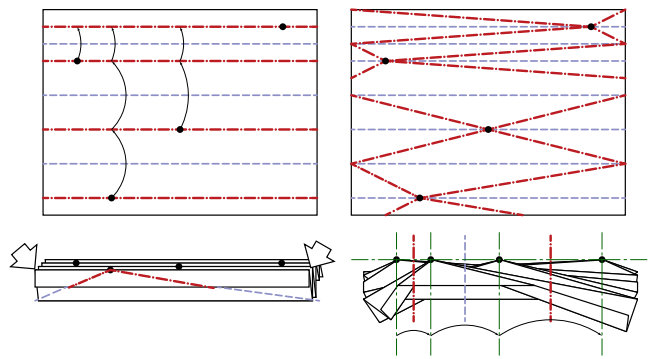

**Fig. 6** If we fold the paper by mountain creases  $y = y_i$  ( $1 \leq i \leq n$ ) and valley creases  $y = (y_i + y_{i+1})/2$  ( $1 \leq i \leq n - 1$ ), we get the product on the left side. If we reverse-fold each mountain by a sufficiently small angle at  $p_i$ , we get the product on the right side. In either case, the  $p_i$ 's are all on a horizontal line, and in the latter case, no other points cover these points.

We can implement essentially the same construction by a folding sequence of some-layers simple folds; refer to Fig. 7. For each  $i$ , we fold the horizontal valley crease  $y = (y_{i-1} + y_i)/2$  (one layer); then the horizontal mountain crease  $y = y_i$  (one layer); then each of two near-horizontal valley folds at  $p_i$  (two layers each). The valley folds need to be sufficiently close to horizontal to prevent additional overlap in future folds; in particular, it suffices to make the angle (between the valley folds and the horizontal crease  $y = (y_i + y_{i+1})/2$ ) be at most half the angle from the

reverse-fold method from Fig. 6 (which just needed to avoid intersecting creases). In Fig. 7, we fold the valley  $y = (y_{i-1} + y_i)/2$  even for  $i = 1$ , letting  $y_0$  be the top of the paper; and unfold this crease at the end of the sequence. Alternatively, we could skip the first valley fold so that each folding step is some-layers simple fold.

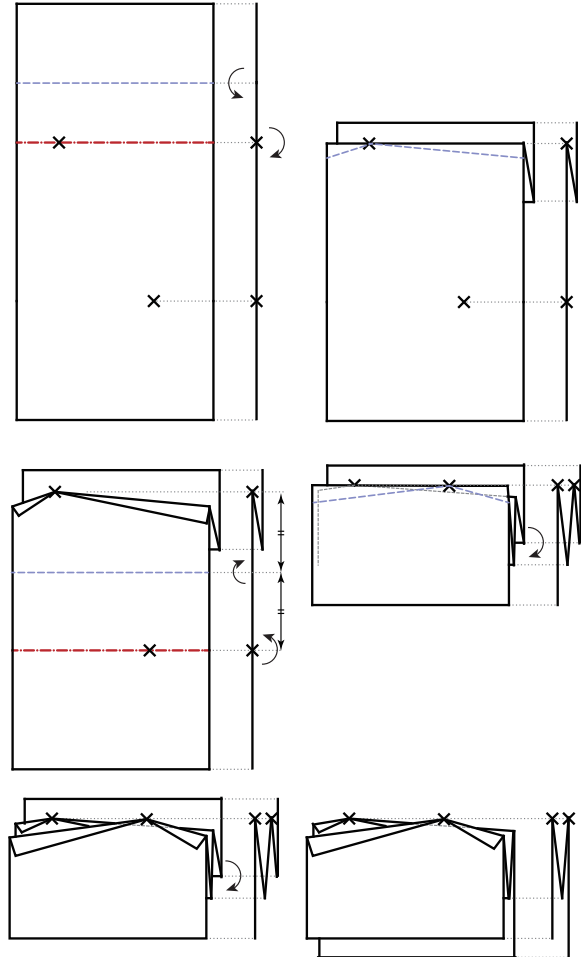

**Fig. 7** How to fold Fig. 6 only by some-layers simple folds.

This method consists of  $\Theta(n)$  simple folds, each folding through 1 or 2 layers. Thus the number of creases is  $\Theta(n)$ , and all creases are nearly horizontal (as in Fig. 6 (right), but with a different mountain–valley assignment). When we apply the  $\Theta(n)$  vertical bisection folds of Lemma 3.4, each of the horizontal folds gets split into  $\Theta(n)$  pieces, so we end up with a final crease pattern with  $\Theta(n^2)$  creases. The folding sequence still consists of  $\Theta(n)$  some-layers simple folds.  $\square$

#### 5. Solution for Unbounded Paper, Allowing Creases Through Points

**Theorem 5.1.** *Let  $P = \mathbb{R}^2$  and let  $p_1, p_2, \dots, p_n$  be  $n$  distinct points on  $P$ . Then there exists a flat folding satisfying Properties F1 and F2, allowing creases through  $\{p_i\}$ . The number of creases is  $O(n^2)$ . The flat folding is the result of a folding sequence of  $O(n)$  flat folding steps of complexity  $O(1)$ .*

*Proof.* The difference from Theorem 4.1 is that we cannot fold the near-horizontal folds in Figs. 6 or 7 because the paper  $P$  is

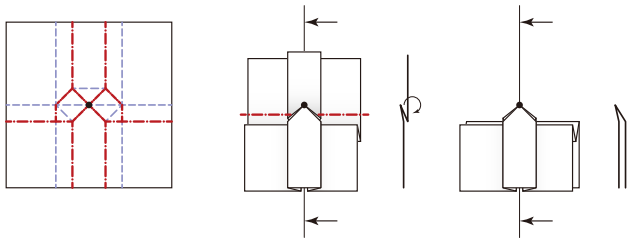

**Fig. 8** The thorn gadget folds an infinite sheet of paper (left) into a plane with a small triangular tab (middle). The gadget is composed of 27 creases and 19 faces, so it is an all-layers flat folding step of complexity 18.

the plane  $\mathbb{R}^2$ , so any near-horizontal lines would intersect all horizontal folds. Instead, we use the *thorn gadget* shown in Fig. 8. If the thorn gadget is applied to a point, the paper folds into a plane (with horizontal and vertical pleats) with a little triangle tab sticking out. By first rotating the point set, we can assume that all  $x$  and  $y$  coordinates are distinct, and thus sufficiently small horizontal and vertical pleats in the thorn gadget will avoid interaction with any other points.

Fig. 9 illustrates the overall construction. We alternately apply the thorn gadget (as an all-layers flat folding step), and the bisection between horizontal lines (similar to Theorem 4.1), sequentially from the top to down. The result is a plane with  $n$  horizontally aligned tabs, with the  $n$  points at the tips of the tabs. One horizontal mountain fold beneath the triangular tabs leaves the tips of the tabs (where the points are) uncovered by other layers of paper, and on the horizontal line. Finally, we can apply Lemma 3.4 to align the points.

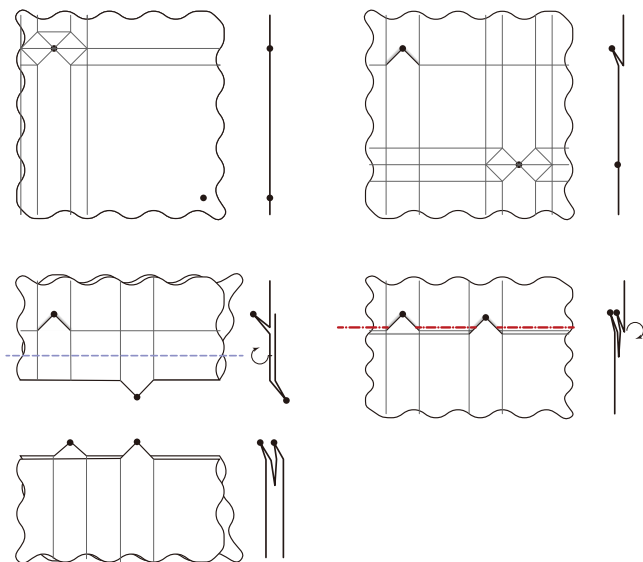

**Fig. 9** The folding sequence for infinite paper, crease passing case. Each flat folding step has complexity  $O(1)$ . The final folding step is a simple fold/unfold as drawn, but by shifting the fold line up slightly, it is a simple fold.

This method consists of  $\Theta(n)$  flat folding steps, each of complexity  $O(1)$ : 1 for the simple folds and 18 for the thorn gadget of Fig. 8 (which is all-layers). For each point  $p_i$ , the thorn gadget makes horizontal and vertical pleats that cross the pleats of all previous gadgets. Thus each gadget makes  $O(n)$  creases, for a total of  $O(n^2)$  creases. Similarly, Lemma 3.4 results in  $\Theta(n^2)$  additional

creases because  $\Theta(n)$  vertical creases will cross  $\Theta(n)$  horizontal pleats. We conclude that the number of resulting creases is  $\Theta(n^2)$ .  $\square$

## 6. Solution for Bounded Paper, Forbidding Creases Through Points

**Theorem 6.1.** *Let  $P$  be a bounded piece of paper and let  $p_1, p_2, \dots, p_n$  be  $n$  distinct points on  $P$ . Then there exists a flat folding satisfying Properties F1 and F2, forbidding creases through  $\{p_i\}$ . The number of creases is  $O(n^3 r')$ . The flat folding is the result of a folding sequence of  $O(n \log r')$  some-layers simple folds.*

**Lemma 6.2** (Radial shrink folding). *Consider three noncollinear points  $p_0, q_1, q_2$  on a convex piece of paper  $P$ , defining a wedge (and angle)  $\angle q_1 p_0 q_2$  from ray  $p_0 q_1$  clockwise to ray  $p_0 q_2$ . Assume that  $p_0$  is not interior to  $P$ , so that removing the fan  $\angle q_1 p_0 q_2$  separates  $P$  into two components. Then, for any  $\varepsilon > 0$ , there exists a folding  $f$  of  $\mathbb{R}^2$  satisfying*

- (R1) *the angle  $\angle f(q_1) f(p_0) f(q_2) \leq \varepsilon$ ;*
- (R2) *the set of points  $q$  of  $P$  nonstrictly counterclockwise of ray  $p_0 q_1$  (including  $q_1$ ) move as a single rotation around  $p_0$  and are singly covered in  $f$ ;*
- (R3) *the set of points  $q$  of  $P$  nonstrictly clockwise of ray  $p_0 q_2$  (including  $q_2$ ) move as a single rotation around  $p_0$  and are singly covered in  $f$ ; and*
- (R4)  *$f(q)$  does not change the distance to  $p_0$  of any  $q \in P$ .*

Also,  $f$  decomposes into a sequence of  $O(\log(\angle q_1 p_0 q_2 / \varepsilon)) = O(\log(1/\varepsilon))$  simple folds, all passing through  $p_0$ , and the total number of creases is  $O(\angle q_1 p_0 q_2 / \varepsilon) = O(1/\varepsilon)$ .

*Proof.* Let  $w = \angle q_1 p_0 q_2 - \varepsilon$ , and assume  $w > 0$ . (Otherwise, Property R1 holds without any folding.) Refer to Fig. 10.

To get started, keep fixed the set of points  $q$  nonstrictly counterclockwise of ray  $p_0 q_1$ , valley fold along the ray from  $p_0$  that is  $\varepsilon/2$  clockwise of ray  $p_0 q_1$ , and mountain fold along the ray bisecting the wedge  $\angle q_1 p_0 q_2$ . We obtain a folded state  $f_1$  where  $f_1(q_1) = q_1$ ,  $f_1(p_0) = p_0$ , and angle  $\angle q_1 p_0 f(q_2) = \angle q_1 p_0 q_2 - w = \varepsilon$ .

This folded state  $f_1$  has a two-layer flap of angle  $w/2$ . By applying a simple fold to the layers of this flap, bisecting its angle, we may shrink the flap angle by a factor of 2, without moving the rest of the paper. After  $k$  such simple folds, we shrink the angle of the tuck to  $w/2^{k+1}$ . Thus, if we apply  $\log(\angle q_1 p_0 q_2 / \varepsilon) + 1$  simple folds (resulting in  $\Theta(\angle q_1 p_0 q_2 / \varepsilon)$  creases), we can shrink the flap to width  $< \varepsilon/2$ , clearing any overlap with points of  $P$  outside the wedge  $\angle q_1 p_0 q_2$ . Thus, in the final folded state  $f$ , we obtain the single coverage required by Properties R2 and R3, without affecting Property R1 already true of  $f_1$ . The rest of Properties R2 and R3, and Property R4, follow because our folds are all rays through  $p_0$  and strictly between rays  $p_0 q_1$  and  $p_0 q_2$ .  $\square$

*Proof of Theorem 6.1.* We assume that  $r'$  is bounded, i.e.,  $R_i \neq R_j$  for all  $i \neq j$ . For example, this property can be achieved by the translation in Lemma 3.8, which guarantees that  $r' = O(rn^2)$ .

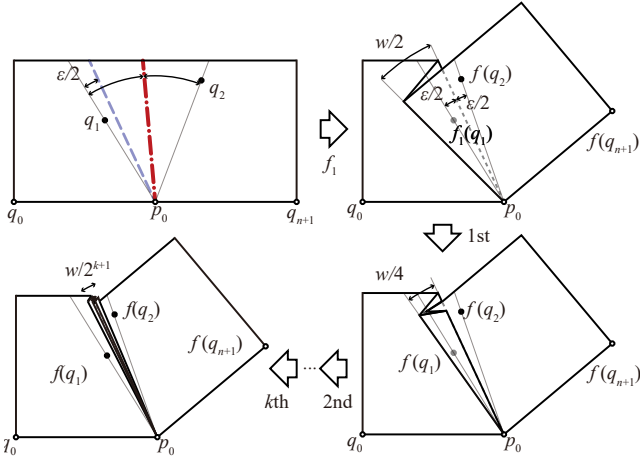

Fig. 10 Radial shrink folding: reducing a wedge down to a thin fan.

By relabeling the points, we arrange to have  $R_i < R_j$  for all  $i < j$ . Also, we compute the permutation of the points  $p_1, p_2, \dots, p_n$  (according to this radius order) into their clockwise order  $q_1, q_2, \dots, q_n$  around  $p_0$ . In addition, let  $q_0$  be the counterclockwise-most point of  $P$  relative to  $p_0$ , and let  $q_{n+1}$  be the clockwise-most point of  $P$  relative to  $p_0$ . Thus  $q_0, q_1, \dots, q_n, q_{n+1}$  appear in clockwise order around  $p_0$ .

The fold sequence consists of two parts. In the first part, we bring  $q_0, q_1, \dots, q_{n+1}$  to be almost collinear, as follows. Divide the paper  $P$  into wedges with apex at  $p_0$  which have  $p_i$ 's on their boundaries (and have no  $p_i$ 's strictly interior to a wedge). For each  $0 \leq i \leq n$ , we apply Lemma 6.2 to shrink the angle of the wedge  $\angle q_i p_0 q_{i+1}$  down to  $\leq \theta/n$ , while only rotating the other wedges. After these folds, all of the paper lies within a wedge with apex at  $p_0$  of angle  $\leq \theta$ , for desired  $\theta > 0$ . We use

$$\theta = \min_{1 \leq i \leq n-1} \frac{R_{i+1} - R_i}{R_{i+1}} > 1/r'.$$

Thus this part consists of  $O(n \log(n/\theta)) = O(n \log(nr')) = O(n \log r')$  simple folds (because  $r' = \Omega(n)$ ) and  $O(n(n/\theta)) = O(n^2 r')$  creases.

In the second part of the fold sequence, we bring the  $p_i$ 's to a common point by bisection folding steps. Refer to Fig. 11. For  $1 \leq k < n$ , let  $b_k$  be the perpendicular bisector of the segment  $p_k p_{k+1}$ . It suffices to fold the paper along these  $b_k$ 's, assigning  $b_k$  as mountain for  $k$  odd and valley for  $k$  even. This part consists of  $O(n)$  simple folds, each of which can cross the  $O(n^2 r')$  creases from the first part. Thus the total number of creases is  $O(n^3 r')$ .

Let  $X$  and  $Y$  be any points on the arcs of circles centered at  $p_0$  and with radii  $R_i$  and  $R_{i+1}$  (i.e., passing through  $p_i$  and  $p_{i+1}$ ), respectively. By the definition of  $\theta$ ,

$$\begin{aligned} p_i X &< R_i \theta < R_i \min_{1 \leq k < n} \frac{R_{k+1} - R_k}{R_{k+1}} \\ &< R_i \frac{R_{i+1} - R_i}{R_{i+1}} < R_{i+1} - R_i < p_{i+1} X. \end{aligned}$$

Similarly,

$$p_{i+1} Y < p_i Y.$$

Therefore, all perpendicular bisectors lie between adjacent arcs, and do not cross each other. This completes the proof.  $\square$

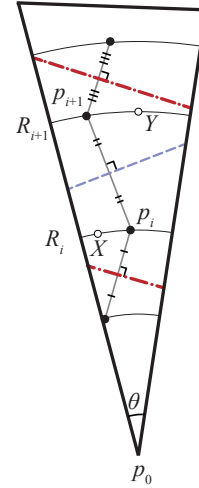

Fig. 11 Each bisector lies between adjacent arcs.

## 7. Solution for Unbounded Paper, Forbidding Creases Through Points

**Theorem 7.1.** Let  $P = \mathbb{R}^2$  and let  $p_1, p_2, \dots, p_n$  be  $n$  distinct points on  $P$ . Then there exists a flat folding satisfying Properties F1 and F2, forbidding creases through  $\{p_i\}$ . The number of creases is  $O(n^2 r'')$ . The flat folding is the result of a folding sequence of  $O(n \log r'')$  folding steps of complexity  $O(1)$ .

**Lemma 7.2** (Parallel shrink folding). Consider points  $q_1, q_2 \in \mathbb{R}^2$  with distinct  $y$  coordinates  $y_1 > y_2$ . Then, for any  $\varepsilon > 0$ , there exists a folding  $f$  of  $\mathbb{R}^2$  satisfying

- (P1)  $|(y \text{ coordinate of } f(q_1)) - (y \text{ coordinate of } f(q_2))| \leq \varepsilon;$
- (P2) the set of points  $q$  with  $y$  coordinate  $\geq y_1$  (including  $q_1$ ) move as a single translation and are singly covered in  $f$ ;
- (P3) the set of points  $q$  with  $y$  coordinate  $\leq y_2$  (including  $q_2$ ) move as a single translation and are singly covered in  $f$ ; and
- (P4)  $f(q)$  does not change the  $x$  coordinate of any  $q \in \mathbb{R}^2$ .

Also,  $f$  decomposes into a sequence of  $O(\log(|y_1 - y_2|/\varepsilon))$  simple folds, all parallel to the  $x$  axis.

The proof of Lemma 7.2 is essentially the same as that of Lemma 6.2 after a projective transformation to place  $p_0$  at infinity, but we repeat it for completeness.

*Proof.* Let  $w = y_1 - y_2 - \varepsilon$ , and assume  $w > 0$ . (Otherwise, Property P1 holds without any folding.) Refer to Fig. 12.

To get started, keep fixed the set of points  $q$  with  $y$  coordinate  $\geq y_1$ , valley fold along crease  $y = y_1 - \varepsilon/2$ , and mountain fold along crease  $y = (y_1 + y_2)/2$ . We obtain a folded state  $f_1$  where  $f_1(q_1) = q_1$  and the  $y$  coordinate of  $f_1(q_2)$  is  $y_2 + w = y_1 - \varepsilon$ . Thus

$$(y \text{ coordinate of } f_1(q_1)) - (y \text{ coordinate of } f_1(q_2)) = \varepsilon.$$

This folded state  $f_1$  has a two-layer flap of width  $w/2$ . By applying a simple fold to the layers of this flap in the middle  $y$  coordinate, we may shrink the flap width by a factor of 2, without moving the rest of the paper. After  $k$  such simple folds, we shrink the width of the tuck to  $w/2^{k+1}$ . Thus, if we apply



$\log((y_1 - y_2) / \varepsilon) + 1$  simple folds, we can shrink the flap to width  $< \varepsilon/2$ , clearing any overlap with the points  $q$  having  $y$  coordinate  $\geq y_1$  or  $\leq y_1$ . Thus, in the final folded state  $f$ , we obtain the single coverage required by Properties P2 and P3, without affecting Property P1 already true of  $f_1$ . The rest of Properties P2 and P3, and Property P4, follow because our folds are all horizontal with  $y$  coordinates strictly between  $y_1$  and  $y_2$ .  $\square$

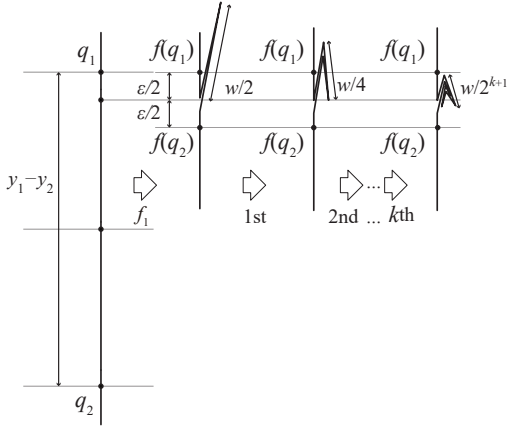

**Fig. 12** Parallel shrink folding: reducing a horizontal strip down to small height.

*Proof of Theorem 7.1.* Let  $x_i$  and  $y_i$  be the  $x$  and  $y$  coordinates of  $p_i$  respectively. By suitable rotation, assume that all  $x_i$ 's are distinct and that all  $y_i$ 's are distinct. By relabeling the points, assume  $y_1 > y_2 > \dots > y_n$ . Define  $y_{n+1} = -\infty$ .

We apply an iterative method. Let  $p_i(k) = (x_i(k), y_i(k))$  denote the position of  $p_i$  before the  $k$ th iteration. For each point  $p_i(k)$ , we can uniquely define (although they may not exist) its left and right adjacent points in the projection of  $p_1(k), p_2(k), \dots, p_n(k)$  to the  $x$  axis; let  $i^-(k)$  and  $i^+(k)$  denote the index of the left and right adjacent points respectively.

Assume by induction that

$$y_1(k) = y_2(k) = \dots = y_k(k) > y_{k+1}(k) = y_{k+2}(k) > y_{k+2}(k) = y_{k+2} > \dots > y_n(k) = y_n,$$

and  $i^-(k) = i^-(0)$  and  $i^+(k) = i^+(0)$  for all  $i$ . For an angle  $0 < \theta < \pi/4$ , choose  $\varepsilon > 0$  sufficiently small to satisfy the following conditions:

- (i) 
$$\frac{\varepsilon}{2 \tan \theta} < y_{k+1}(k) - y_{k+2}(k) = y_{k+1} - y_{k+2}.$$
- (ii) There is a sufficient horizontal gap between  $p_{k+1}(k)$  and its left and right neighbors:

$$\left(\frac{3}{2} + \frac{1}{2 \tan \theta}\right) \varepsilon < x_{(k+1)^+}(k) - x_{k+1}(k)$$

$$\left(\frac{3}{2} + \frac{1}{2 \tan \theta}\right) \varepsilon < x_{k+1}(k) - x_{(k+1)^-}(k)$$

By applying parallel shrink folding of Lemma 7.2, we can obtain that  $d(k) := y_k(k) - y_{k+1}(k) \leq \varepsilon$ . Then we apply the *downshifting gadget*, a folding composed of two alternating twist folds of twist angle  $\theta$  and pleats width  $\frac{1}{2}d(k)$ ; see Fig. 13. The

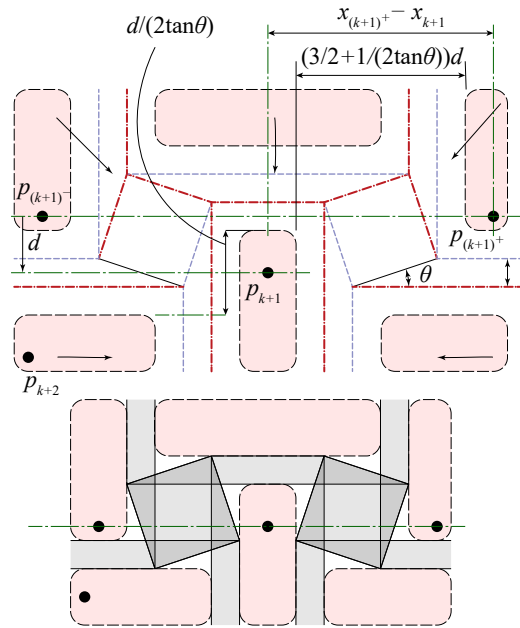

**Fig. 13** Downshifting gadget can be inserted if conditions (i)–(ii) are satisfied.

pleats of unfolded width  $\frac{3}{2}d(k)$  decompose the paper into six regions which remain single layered in the folding. The top three regions translate down by  $d(k)$ ; the left two regions translate right by  $d(k)$ ; and the right two regions translate left by  $d(k)$ . Now, the downshifting gadget is constructed to weave between the given points, such that (1) the neighborhoods of  $p_1, p_2, \dots, p_n$  are kept single layered, (2) already aligned points  $p_1, p_2, \dots, p_k$  are in the top left and top right regions, (3) point  $p_{k+1}$  is in the bottom middle region, and (4) the rest of the points  $p_{k+2}, \dots, p_n$  are in the bottom left and bottom right regions. Conditions (i)–(ii) guarantee the necessary clearance between points separated by the pleats. After folding the gadget,  $y_1, y_2, \dots, y_k, y_{k+1}$  coincide, and each point of  $p_1, p_2, \dots, p_n$  has no other points of paper on it.

Now we have

$$y_1(k+1) = y_2(k+1) = \dots = y_{k+1}(k+1) > y_{k+2}(k+1) = y_{k+2}(k+1) > y_{k+3}(k+1) = y_{k+3} > \dots > y_n(k+1) = y_n.$$

Because  $\left(\frac{3}{2} + \frac{1}{2 \tan \theta}\right) \varepsilon > \varepsilon \geq d(k)$ , the horizontal ordering of points does not change, and thus  $i^-(k+1) = i^-$  and  $i^+(k+1) = i^+$ . The horizontal gap shrinks by multiplying by a factor of at least  $\frac{1 + \tan \theta}{1 + 3 \tan \theta} < 1$ . By induction, the points  $p_1, p_2, \dots, p_n$  become collinear after  $n - 1$  iterations. Therefore we can apply the bisection fold of Lemma 3.4 to get the desired folding.

Before we count the number of resulting creases, we discuss how small  $y_k - y_{k+1}$  should be to apply the shrink fold  $f_s$  of Lemma 7.2. Let  $y'_i(k)$  denote the  $y$  coordinate of  $f_s(p_i(k))$ . For each step  $k$ , we apply Lemma 7.2 so that  $y'_k(k) - y'_{k+1}(k) < \varepsilon$ . To satisfy the conditions (i)–(ii) above for each  $k$ , it suffices to satisfy the following:

$$C \cdot (y'_k(k) - y'_{k+1}(k)) < \min \left( \min_{j \neq k} |x_k - x_j|, \min_{k < j \leq n} |y_k - y_j| \right), \quad (3)$$

where  $C$  is a constant satisfying the following:

$$0 < C < \frac{1}{2 \tan \theta} < \frac{1}{2} + \frac{1}{2 \tan \theta}.$$

Note that  $C$  depends only on  $\theta$ . Here, we used that the horizontal displacement between horizontally adjacent points  $x_i$  and  $x_{i+}$  can occur only twice in the whole sequence. This ensures that the right-hand sides of condition (ii) are bounded by the original gap scaled by a constant factor:

$$x_{i+}(m) - x_i(m) < \frac{1 + \tan \theta}{1 + 3 \tan \theta} (x_{i+} - x_i), \quad (4)$$

$$x_i(m) - x_{i-}(m) < \frac{1 + \tan \theta}{1 + 3 \tan \theta} (x_i - x_{i-}). \quad (5)$$

In Lemma 7.2, we make  $O(\log r'')$  shrink folds. Then we have

$$y'_i - y'_{i+1} \leq \frac{1}{Cr''} (y_i - y_{i+1}).$$

By the definition of  $r''$  in (2), Equation (3) holds.

We divide the whole folding process into two parts: folding steps before applying Lemma 3.4 and folding steps in Lemma 3.4. The latter part consists of  $n - 1$  vertical simple folds. The former part is divided into  $n - 1$  inductive steps above. For each inductive step, we first apply Lemma 7.2 to make  $O(\log r'')$  simple folds, resulting in  $O(r'')$  total creases. Next we use the downshifting gadget, which consists of  $O(1)$  horizontal, vertical, and diagonal creases. The total number of folding steps is thus  $O(n \log r'')$  for the former part plus  $O(n)$  for the latter part, for a total of  $O(n \log r'')$ . To bound the total number of resulting creases, we consider diagonal creases as both vertical and horizontal creases. Considering crosses between horizontal and vertical creases, we conclude that the total number of resulting creases is  $O(n(n + nr'')) = O(n^2 r'')$ .  $\square$

## 8. Open Problems

The natural open problems are to improve the bounds on the number of folding steps of complexity  $O(1)$ , and the resulting number of creases, from Table 1. When allowing creases through points, are  $\Theta(n^2)$  creases necessary, or do  $O(n)$  creases suffice, e.g., by trying to fold along the Voronoi diagram? When forbidding creases through points, is a dependence on  $r$  necessary or is a polynomial dependence on  $n$  possible? Can unbounded paper be solved by simple folds, or are folding steps of complexity  $> 1$  necessary?

Another peculiar open problem is the worst-case ratio between  $r$  and either  $r'$  or  $r''$ . We proved that the ratio is  $O(n^2)$ , and simple examples (e.g., a regular  $n$ -gon) show that the ratio can be  $\Omega(n)$ . Is the tight bound one of these extremes, or something in between?

Finally, Fig. 2 illustrates that our definition of folding step complexity does not intuitively capture the complexity in the layering between clusters. Can we define a notion of *layer complexity* to measure this?

## Acknowledgment

We thank Masaki Watanabe for the idea for solving the case of bounded paper, allowing creases through points (Section 4). We thank Jason Ku for helpful discussions about folding step complexity. We thank the referees for helpful comments.

## References

- [1] Akitaya, H., Demaine, E. D. and Ku, J. S.: Simple Folding is Really Hard, *Abstracts from the 19th Japan Conference on Discrete and Computational Geometry, Graphs and Games (JCDCGGG 2016)*, Tokyo, Japan (2016).
- [2] Arkin, E. M., Bender, M. A., Demaine, E. D., Demaine, M. L., Mitchell, J. S. B., Sethia, S. and Skiena, S. S.: When Can You Fold a Map?, *Computational Geometry: Theory and Applications*, Vol. 29, No. 1, pp. 23–46 (2004).
- [3] Bern, M., Demaine, E., Eppstein, D. and Hayes, B.: A Disk-Packing Algorithm for an Origami Magic Trick, *Origami<sup>3</sup>: Proceedings of the 3rd International Meeting of Origami Science, Math, and Education*, Monterey, California, pp. 17–28 (2001).
- [4] Demaine, E. D. and Demaine, M. L.: Fun with Fonts: Algorithmic Typography, *Theoretical Computer Science*, Vol. 586, pp. 111–119 (2015).
- [5] Demaine, E. D., Demaine, M. L. and Lubiw, A.: Folding and Cutting Paper, *Revised Papers from the Japan Conference on Discrete and Computational Geometry* (Akiyama, J., Kano, M. and Urabe, M., eds.), Lecture Notes in Computer Science, Vol. 1763, Tokyo, Japan, pp. 104–117 (1998).
- [6] Demaine, E. D. and O’Rourke, J.: *Geometric Folding Algorithms: Linkages, Origami, Polyhedra*, Cambridge University Press (2007).



**Yasuhiko Asao** is a Ph.D student in Graduate School of Mathematical Sciences, The University of Tokyo. He is interested broadly in geometry and topology.



**Erik D. Demaine** received a B.Sc. degree from Dalhousie University in 1995, and M.Math. and Ph.D. degrees from the University of Waterloo in 1996 and 2001, respectively. Since 2001, he has been a professor in computer science at the Massachusetts Institute of Technology. His research interests range throughout algorithms, from data structures for improving web searches to the geometry of understanding how proteins fold to the computational difficulty of playing games. In 2003, he received a MacArthur Fellowship as a “computational geometer tackling and solving difficult problems related to folding and bending—moving readily between the theoretical and the playful, with a keen eye to revealing the former in the latter”. He cowrote a book about the theory of folding, together with Joseph O’Rourke (*Geometric Folding Algorithms*, 2007), and a book about the computational complexity of games, together with Robert Hearn (*Games, Puzzles, and Computation*, 2009). With his father Martin, his interests span the connections between mathematics and art.



**Martin L. Demaine** is an artist and computer scientist. He started the first private hot glass studio in Canada and has been called the father of Canadian glass. Since 2005, he has been the Angelika and Barton Weller Artist-in-Residence at the Massachusetts Institute of Technology. Martin works together with his son Erik in paper,

glass, and other material. Their artistic work includes curved origami sculptures in the permanent collections of the Museum of Modern Art in New York, and the Renwick Gallery in the Smithsonian. Their scientific work includes over 60 published joint papers, including several about combining mathematics and art.

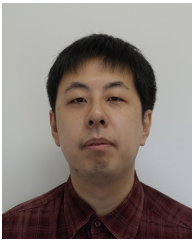

**Hideaki Hosaka** is a highschool teacher in mathematics at the Azabu Junior-High School. He received a Bachelor degree of Science and Master degree of Mathematical Sciences from the University of Tokyo in 2009 and 2011, respectively. His interest is algebraic representation theory and combinatorics.



**Akitoshi Kawamura** received his PhD in Computer Science from the University of Toronto in 2011. He then worked as research associate at the Department of Computer Science, University of Tokyo, and since 2015 he is an assistant professor at the Department of General Systems Studies, University of Tokyo. His research

interests are in theory of computation, algorithm design, and discrete geometry.



**Tomohiro Tachi** is an assistant professor in Graphic and Computer Sciences at the University of Tokyo. He studied architecture and received his Ph.D. degree in Engineering from the University of Tokyo. He has been designing origami from 2002 and keeps exploring three-dimensional and kinematic origami

through computation. He developed software tools including “rigid origami simulator”, “origamizer”, and “freeform origami”, which are available from his website. His research interests include origami, structural morphology, computational design, and fabrication.

**Kazune Takahashi** is a Ph.D. course student in Graduate School of Mathematical Sciences, the University of Tokyo. He studied pure mathematics and received his M.Sc. degree in Mathematical Sciences from the University of Tokyo in 2015. His research interests include elliptic partial differential equations, critical exponents

and variational methods. He is strong at programming contests. He has won in a domestic AI competition “Code Runner 2015” and got a prize in an international AI competition “Samurai Coding 2014-15”.